

# Dual and Quad Rail-to-Rail Output, Picoamp Input Precision Op Amps

## FEATURES

- **Offset Voltage: 50 $\mu$ V Maximum (LT1881A)**
- **Input Bias Current: 200pA Maximum (LT1881A)**
- **Offset Voltage Drift: 0.8 $\mu$ V/ $^{\circ}$ C Maximum**
- **Rail-to-Rail Output Swing**
- **Supply Range: 2.7V to 36V**
- Operates with Single or Split Supplies
- Open-Loop Voltage Gain: 1 Million Minimum
- 1mA Maximum Supply Current Per Amplifier
- Stable at  $A_V = 1$ ,  $C_L = 1000\text{pF}$
- Standard Pinouts
- Wide Operating Temperature Range:  
-55 $^{\circ}$ C to 125 $^{\circ}$ C (LT1882)

## APPLICATIONS

- Thermocouple Amplifiers
- Bridge Transducer Conditioners
- Instrumentation Amplifiers
- Battery-Powered Systems
- Photo Current Amplifiers

LT, LT, LTC, LTM, Linear Technology and the Linear logo are registered trademarks of Linear Technology Corporation. All other trademarks are the property of their respective owners.

## DESCRIPTION

The LT<sup>®</sup>1881 and LT1882 op amps bring high accuracy input performance to amplifiers with rail-to-rail output swing. Input bias currents and capacitive load driving capabilities are superior to the similar LT1884 and LT1885 amplifiers, at the cost of a slight loss in speed. Input offset voltage is trimmed to less than 50 $\mu$ V and the low drift maintains this accuracy over the operating temperature range. Input bias currents are an ultralow 200pA maximum.

The amplifiers work on any total power supply voltage between 2.7V and 36V (fully specified from 5V to  $\pm 15$ V). Output voltage swings to within 40mV of the negative supply and 220mV of the positive supply make these amplifiers good choices for low voltage single supply operation.

Capacitive loads up to 1000pF can be driven directly in unity-gain follower applications.

The dual LT1881 and LT1881A are available with standard pinouts in S8 and PDIP packages. The quad LT1882 is in a 14-pin SO package. For a higher speed device with similar DC specifications, see the LT1884/LT1885.

## TYPICAL APPLICATION

16-Bit Voltage Output DAC on  $\pm 5$ V Supply

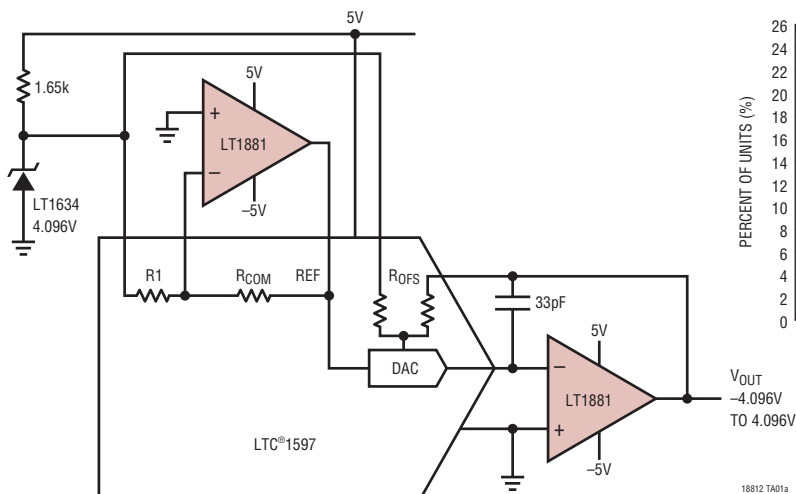

TC  $V_{OS}$  Distribution, Industrial Grade

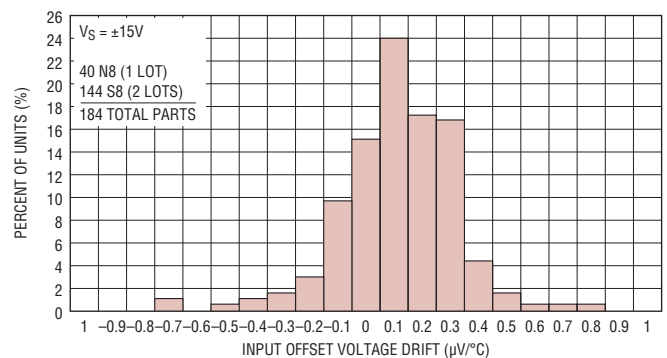

18812f

# LT1881/LT1882

## ABSOLUTE MAXIMUM RATINGS (Note 1)

Supply Voltage ( $V^+$ to $V^-$ ).....	40V
Differential Input Voltage (Note 2).....	$\pm 10V$
Input Voltage.....	$V^+$ to $V^-$
Input Current (Note 2).....	$\pm 10mA$
Output Short-Circuit Duration (Note 3) .....	Indefinite
Operating Temperature Range (Note 4)	
LT1881C/LT1882C.....	$-40^\circ C$ to $85^\circ C$
LT1881I/LT1882I.....	$-40^\circ C$ to $85^\circ C$
LT1882H.....	$-40^\circ C$ to $125^\circ C$
LT1882MP.....	$-55^\circ C$ to $125^\circ C$

Specified Temperature Range (Note 5)	
LT1881C/LT1882C.....	$-40^\circ C$ to $85^\circ C$
LT1881I/LT1882I.....	$-40^\circ C$ to $85^\circ C$
LT1882H.....	$-40^\circ C$ to $125^\circ C$
LT1882MP.....	$-55^\circ C$ to $125^\circ C$
Maximum Junction Temperature.....	$150^\circ C$
Storage Temperature Range.....	$-65^\circ C$ to $150^\circ C$
Lead Temperature (Soldering, 10 sec) .....	$300^\circ C$

## PIN CONFIGURATION



## ORDER INFORMATION

LEAD FREE FINISH	TAPE AND REEL	PART MARKING	PACKAGE DESCRIPTION	SPECIFIED TEMPERATURE RANGE
LT1881CN8#PBF	LT1881CN8#TRPBF	LT1881CN8	8-Lead PDIP	$0^\circ C$ to $70^\circ C$
LT1881IN8#PBF	LT1881IN8#TRPBF	LT1881IN8	8-Lead PDIP	$-40^\circ C$ to $85^\circ C$
LT1881CS8#PBF	LT1881CS8#TRPBF	1881	8-Lead Plastic SO	$0^\circ C$ to $70^\circ C$
LT1881IS8#PBF	LT1881IS8#TRPBF	1881I	8-Lead Plastic SO	$-40^\circ C$ to $85^\circ C$
LT1881ACN8#PBF	LT1881ACN8#TRPBF	LT1881ACN8	8-Lead PDIP	$0^\circ C$ to $70^\circ C$
LT1881AIN8#PBF	LT1881AIN8#TRPBF	LT1881AIN8	8-Lead PDIP	$-40^\circ C$ to $85^\circ C$
LT1881ACS8#PBF	LT1881ACS8#TRPBF	1881A	8-Lead Plastic SO	$0^\circ C$ to $70^\circ C$
LT1881AIS8#PBF	LT1881AIS8#TRPBF	1881AI	8-Lead Plastic SO	$-40^\circ C$ to $85^\circ C$
LT1882CS#PBF	LT1882CS#TRPBF	LT1882CS	14-Lead Plastic SO	$0^\circ C$ to $70^\circ C$
LT1882IS#PBF	LT1882IS#TRPBF	LT1882IS	14-Lead Plastic SO	$-40^\circ C$ to $85^\circ C$
LT1882HS#PBF	LT1882HS#TRPBF	LT1882HS	14-Lead Plastic SO	$-40^\circ C$ to $125^\circ C$
LT1882MPS#PBF	LT1882MPS#TRPBF	LT1882MPS	14-Lead Plastic SO	$-55^\circ C$ to $125^\circ C$

Consult LTC Marketing for parts specified with wider operating temperature ranges.

For more information on lead free part marking, go to: <http://www.linear.com/leadfree/>

For more information on tape and reel specifications, go to: <http://www.linear.com/tapeandreeel/>

18812fb

**ELECTRICAL CHARACTERISTICS** The ● denotes the specifications which apply over the full operating temperature range, otherwise specifications are at  $T_A = 25^\circ\text{C}$ . Single supply operation  $V_S = 5\text{V}, 0\text{V}$ ;  $V_{CM} = V_S/2$  unless otherwise noted. (Note 5)

SYMBOL	PARAMETER	CONDITIONS	C/I Grades			H/MP Grades			UNITS
			MIN	TYP	MAX	MIN	TYP	MAX	
$V_{OS}$	Input Offset Voltage (LT1881A)	$0^\circ\text{C} < T_A < 70^\circ\text{C}$ $-40^\circ\text{C} < T_A < 85^\circ\text{C}$	●	25	50				$\mu\text{V}$ $\mu\text{V}$ $\mu\text{V}$
	Input Offset Voltage (LT1881/LT1882)	$0^\circ\text{C} < T_A < 70^\circ\text{C}$ $-40^\circ\text{C} < T_A < 85^\circ\text{C}$ $-40^\circ\text{C} < T_A < 125^\circ\text{C}$ $-55^\circ\text{C} < T_A < 125^\circ\text{C}$	● ● ● ●	30	80 125 150	30	80	300 300	$\mu\text{V}$ $\mu\text{V}$ $\mu\text{V}$ $\mu\text{V}$ $\mu\text{V}$
$\Delta V_{OS}/\Delta T$	Input Offset Voltage Drift (Note 6)	$0^\circ\text{C} < T_A < 70^\circ\text{C}$ $-40^\circ\text{C} < T_A < 85^\circ\text{C}$	● ●	0.3	0.8				$\mu\text{V}/^\circ\text{C}$ $\mu\text{V}/^\circ\text{C}$
		$-40^\circ\text{C} < T_A < 125^\circ\text{C}$ $-55^\circ\text{C} < T_A < 125^\circ\text{C}$	● ●			0.3	0.8	0.3	$\mu\text{V}/^\circ\text{C}$ $\mu\text{V}/^\circ\text{C}$
$\Delta V_{OS}/\Delta \text{TIME}$	Long-Term Input Offset Voltage Stability			0.3		0.3			$\mu\text{V}/\text{month}$
$I_{OS}$	Input Offset Current (LT1881A)	$0^\circ\text{C} < T_A < 70^\circ\text{C}$ $-40^\circ\text{C} < T_A < 85^\circ\text{C}$	● ●	100	200 250 300				$\text{pA}$ $\text{pA}$ $\text{pA}$
	Input Offset Current (LT1881/LT1882)	$0^\circ\text{C} < T_A < 70^\circ\text{C}$ $-40^\circ\text{C} < T_A < 85^\circ\text{C}$ $-40^\circ\text{C} < T_A < 125^\circ\text{C}$ $-55^\circ\text{C} < T_A < 125^\circ\text{C}$	● ● ● ●	150	500 600 700	150	500	2000 2000	$\text{pA}$ $\text{pA}$ $\text{pA}$ $\text{pA}$ $\text{pA}$
$I_B$	Input Bias Current (LT1881A)	$0^\circ\text{C} < T_A < 70^\circ\text{C}$ $-40^\circ\text{C} < T_A < 85^\circ\text{C}$	● ●	100	200 250 300				$\text{pA}$ $\text{pA}$ $\text{pA}$
	Input Bias Current (LT1881/LT1882)	$0^\circ\text{C} < T_A < 70^\circ\text{C}$ $-40^\circ\text{C} < T_A < 85^\circ\text{C}$ $-40^\circ\text{C} < T_A < 125^\circ\text{C}$ $-55^\circ\text{C} < T_A < 125^\circ\text{C}$	● ● ● ●	150	500 600 700	150	500	3000 3000	$\text{pA}$ $\text{pA}$ $\text{pA}$ $\text{pA}$ $\text{pA}$
	Input Noise Voltage	0.1Hz to 10Hz		0.5		0.5			$\mu\text{V}_{\text{p-p}}$
$e_n$	Input Noise Voltage Density	$f = 1\text{kHz}$		14		14			$\text{nV}/\sqrt{\text{Hz}}$
$i_n$	Input Noise Current Density	$f = 1\text{kHz}$		0.03		0.03			$\text{pA}/\sqrt{\text{Hz}}$
$R_{IN}$	Input Resistance	Differential Mode	●	20		20			$\text{M}\Omega$
		Common Mode	●	100		100			$\text{G}\Omega$
$C_{IN}$	Input Capacitance		●	2		2			$\text{pF}$
$V_{CM}$	Input Voltage Range		●	$V^- + 1.0$ $V^- + 1.2$	$V^+ - 1.0$ $V^+ - 1.2$	$V^- + 1.0$ $V^- + 1.2$	$V^+ - 1.0$ $V^+ - 1.2$		$\text{V}$ $\text{V}$
CMRR	Common Mode Rejection Ratio	$1\text{V} < V_{CM} < 4\text{V}$	●	106	128	106	128		$\text{dB}$
		$1.2\text{V} < V_{CM} < 3.8\text{V}$	●	104		102			$\text{dB}$
PSRR	Power Supply Rejection Ratio	$V^- = 0\text{V}, V_{CM} = 1.5\text{V}$	●						$\text{dB}$
		$0^\circ\text{C} < T_A < 85^\circ\text{C}, 2.7\text{V} < V^+ < 32\text{V}$	●	106		106			$\text{dB}$
		$0^\circ\text{C} < T_A < 125^\circ\text{C}, 2.7\text{V} < V^+ < 32\text{V}$	●						$\text{dB}$
		$T_A = -40^\circ\text{C}, 3\text{V} < V^+ < 32\text{V}$	●	106		106			$\text{dB}$
		$T_A = -55^\circ\text{C}, 3\text{V} < V^+ < 32\text{V}$	●			106		$\text{dB}$	
	Minimum Operating Supply Voltage		●	2.4	2.7	2.4	2.7		$\text{V}$

# LT1881/LT1882

**ELECTRICAL CHARACTERISTICS** The ● denotes the specifications which apply over the full operating temperature range, otherwise specifications are at  $T_A = 25^\circ\text{C}$ . Single supply operation  $V_S = 5\text{V}, 0\text{V}$ ;  $V_{\text{CM}} = V_S/2$  unless otherwise noted. (Note 5)

SYMBOL	PARAMETER	CONDITIONS	C/I Grades			H/MP Grades			UNITS	
			MIN	TYP	MAX	MIN	TYP	MAX		
$A_{\text{VOL}}$	Large-Signal Voltage Gain	$R_L = 10\text{k}; 1\text{V} < V_{\text{OUT}} < 4\text{V}$	● 500 350	1600		500 300	1600		V/mV V/mV	
		$R_L = 2\text{k}; 1\text{V} < V_{\text{OUT}} < 4\text{V}$	● 300 250	800		300 200	800		V/mV V/mV	
		$R_L = 1\text{k}; 1\text{V} < V_{\text{OUT}} < 4\text{V}$	● 250 200	400		250 150	400		V/mV V/mV	
$V_{\text{OL}}$	Output Voltage Swing Low	No Load	●	20	40		20	50	mV	
		$I_{\text{SINK}} = 100\mu\text{A}$	●	25	50		25	60	mV	
		$I_{\text{SINK}} = 1\text{mA}$	●	70	150		70	200	mV	
		$I_{\text{SINK}} = 5\text{mA}$	●	270	600		270	750	mV	
$V_{\text{OH}}$	Output Voltage Swing High (Referred to $V^+$ )	No Load	●	120	220		120	300	mV	
		$I_{\text{SINK}} = 100\mu\text{A}$	●	130	230		130	325	mV	
		$I_{\text{SINK}} = 1\text{mA}$	●	180	300		180	450	mV	
		$I_{\text{SINK}} = 5\text{mA}$	●	360	600		360	800	mV	
$I_S$	Supply Current Per Amplifier	$V_S = 3\text{V}, 0\text{V}$	●	0.45	0.65	0.85 1.2	0.45	0.65	0.85 1.5	mA mA
		$V_S = 5\text{V}, 0\text{V}$	●	0.5	0.65	0.9 1.4	0.5	0.65	0.9 1.7	mA mA
		$V_S = 12\text{V}, 0\text{V}$	●	0.5	0.70	1.0 1.5	0.5	0.70	1.0 1.8	mA mA
$I_{\text{SC}}$	Short-Circuit Current	$V_{\text{OUT}}$ Short to GND	●	15	30		10	30	mA	
		$V_{\text{OUT}}$ Short to $V^+$	●	15	30		10	30	mA	
GBW	Gain Bandwidth Product	$f = 20\text{kHz}$		0.35	1.0		0.35	1.0	MHz	
	Channel Separation	$f = 1\text{kHz}$			120			120	dB	
$t_S$	Settling Time	0.01%, $V_{\text{OUT}} = 1.5\text{V}$ to $3.5\text{V}$ , $A_V = -1$ , $R_L = 2\text{k}$			30			30	$\mu\text{s}$	
$\text{SR}^+$	Slew Rate Positive	$A_V = -1$	●	0.15 0.12	0.35		0.15 0.1	0.35	V/ $\mu\text{s}$ V/ $\mu\text{s}$	
$\text{SR}^-$	Slew Rate Negative	$A_V = -1$	●	0.11 0.08	0.18		0.11 0.06	0.18	V/ $\mu\text{s}$ V/ $\mu\text{s}$	
FPBW	Full-Power Bandwidth	$V_{\text{OUT}} = 4V_{\text{P-P}}$ (Note 10)	●	8.75 6.35	14		8.75 4.75	14	kHz kHz	
		Offset Voltage Match (LT1881A)	(Note 7) $0^\circ\text{C} < T_A < 70^\circ\text{C}$ $-40^\circ\text{C} < T_A < 85^\circ\text{C}$	● ●		30 70 125 160				$\mu\text{V}$ $\mu\text{V}$ $\mu\text{V}$ $\mu\text{V}$
$\Delta V_{\text{OS}}$	Offset Voltage Match (LT1881/LT1882)	(Note 7) $0^\circ\text{C} < T_A < 70^\circ\text{C}$ $-40^\circ\text{C} < T_A < 85^\circ\text{C}$	● ●		35 125 175 235		35	125	$\mu\text{V}$ $\mu\text{V}$ $\mu\text{V}$ $\mu\text{V}$	
		$-40^\circ\text{C} < T_A < 125^\circ\text{C}$	●					385	$\mu\text{V}$	
		$-55^\circ\text{C} < T_A < 125^\circ\text{C}$	●					385	$\mu\text{V}$	
		Offset Voltage Match Drift	(Notes 6, 7)	●		0.4	1.2		0.4	1.2
	$\Delta I_{\text{B}^+}$	Noninverting Bias Current Match (LT1881A)	(Note 7) $0^\circ\text{C} < T_A < 70^\circ\text{C}$ $-40^\circ\text{C} < T_A < 85^\circ\text{C}$	● ●		200 300 400 500				pA pA pA pA

**ELECTRICAL CHARACTERISTICS** The ● denotes the specifications which apply over the full operating temperature range, otherwise specifications are at  $T_A = 25^\circ\text{C}$ . Single supply operation  $V_S = 5\text{V}, 0\text{V}$ ;  $V_{CM} = V_S/2$  unless otherwise noted. (Note 5)

SYMBOL	PARAMETER	CONDITIONS	C/I Grades			H/MP Grades			UNITS
			MIN	TYP	MAX	MIN	TYP	MAX	
$\Delta I_B+$	Noninverting Bias Current Match (LT1881/LT1882)	(Note 7)		250	700	250	700	pA	
		$0^\circ\text{C} < T_A < 70^\circ\text{C}$	●					pA	
		$-40^\circ\text{C} < T_A < 85^\circ\text{C}$	●					pA	
		$-40^\circ\text{C} < T_A < 125^\circ\text{C}$	●					2000	
		$-55^\circ\text{C} < T_A < 125^\circ\text{C}$	●					2000	
$\Delta\text{CMRR}$	Common Mode Rejection Ratio Match	(Notes 7, 9)	●	102	125	100	125	dB	
$\Delta\text{PSRR}$	Power Supply Rejection Match (Notes 7, 9)	$V^- = 0\text{V}, V_{CM} = 1.5\text{V}$							
		$0^\circ\text{C} < T_A < 85^\circ\text{C}, 2.7\text{V} < V^+ < 32\text{V}$	●	104	126			dB	
		$0^\circ\text{C} < T_A < 125^\circ\text{C}, 2.7\text{V} < V^+ < 32\text{V}$	●			102	126	dB	
		$T_A = -40^\circ\text{C}, 3\text{V} < V^+ < 32\text{V}$		104	126			dB	
		$T_A = -55^\circ\text{C}, 3\text{V} < V^+ < 32\text{V}$				102	126	dB	

The ● denotes the specifications which apply over the full operating temperature range, otherwise specifications are at  $T_A = 25^\circ\text{C}$ . Split supply operation  $V_S = \pm 15\text{V}$ ,  $V_{CM} = 0\text{V}$  unless otherwise noted. (Note 5)

SYMBOL	PARAMETER	CONDITIONS	C/I Grades			H/MP Grades			UNITS
			MIN	TYP	MAX	MIN	TYP	MAX	
$V_{OS}$	Input Offset Voltage (LT1881A)	$0^\circ\text{C} < T_A < 70^\circ\text{C}$	●	25	50			$\mu\text{V}$	
		$-40^\circ\text{C} < T_A < 85^\circ\text{C}$	●		85			$\mu\text{V}$	
						110			$\mu\text{V}$
$V_{OS}$	Input Offset Voltage (LT1881/LT1882)	$0^\circ\text{C} < T_A < 70^\circ\text{C}$	●	30	80	30	80	$\mu\text{V}$	
		$-40^\circ\text{C} < T_A < 85^\circ\text{C}$	●		125			$\mu\text{V}$	
		$-40^\circ\text{C} < T_A < 125^\circ\text{C}$	●					300	
		$-55^\circ\text{C} < T_A < 125^\circ\text{C}$	●					300	
									$\mu\text{V}$
$\Delta V_{OS}/\Delta T$	Input Offset Voltage Drift (Note 6)	$0^\circ\text{C} < T_A < 70^\circ\text{C}$	●	0.3	0.8			$\mu\text{V}/^\circ\text{C}$	
		$-40^\circ\text{C} < T_A < 85^\circ\text{C}$	●	0.3	0.8			$\mu\text{V}/^\circ\text{C}$	
		$-40^\circ\text{C} < T_A < 125^\circ\text{C}$	●			0.3	0.8	$\mu\text{V}/^\circ\text{C}$	
		$-55^\circ\text{C} < T_A < 125^\circ\text{C}$	●			0.3	0.8	$\mu\text{V}/^\circ\text{C}$	
$\Delta V_{OS}/\Delta\text{TIME}$	Long-Term Input Offset Voltage Stability			0.3		0.3		$\mu\text{V}/\text{month}$	
$I_{OS}$	Input Offset Current (LT1881A)	$0^\circ\text{C} < T_A < 70^\circ\text{C}$	●	100	200			pA	
		$-40^\circ\text{C} < T_A < 85^\circ\text{C}$	●		250			pA	
						300			pA
$I_{OS}$	Input Offset Current (LT1881/LT1882)	$0^\circ\text{C} < T_A < 70^\circ\text{C}$	●	150	500	150	500	pA	
		$-40^\circ\text{C} < T_A < 85^\circ\text{C}$	●		600			pA	
		$-40^\circ\text{C} < T_A < 125^\circ\text{C}$	●					2000	
		$-55^\circ\text{C} < T_A < 125^\circ\text{C}$	●					2000	
									pA
$I_B$	Input Bias Current (LT1881A)	$0^\circ\text{C} < T_A < 70^\circ\text{C}$	●	100	200			pA	
		$-40^\circ\text{C} < T_A < 85^\circ\text{C}$	●		250			pA	
						300			pA
$I_B$	Input Bias Current (LT1881/LT1882)	$0^\circ\text{C} < T_A < 70^\circ\text{C}$	●	150	500	150	500	pA	
		$-40^\circ\text{C} < T_A < 85^\circ\text{C}$	●		600			pA	
		$-40^\circ\text{C} < T_A < 125^\circ\text{C}$	●					3000	
		$-55^\circ\text{C} < T_A < 125^\circ\text{C}$	●					3000	
									pA

# LT1881/LT1882

**ELECTRICAL CHARACTERISTICS** The ● denotes the specifications which apply over the full operating temperature range, otherwise specifications are at  $T_A = 25^\circ\text{C}$ . Split supply operation  $V_S = \pm 15\text{V}$ ,  $V_{CM} = 0\text{V}$  unless otherwise noted. (Note 5)

SYMBOL	PARAMETER	CONDITIONS	C/I Grades			H/MP Grades			UNITS
			MIN	TYP	MAX	MIN	TYP	MAX	
	Input Noise Voltage	0.1Hz to 10Hz		0.5		0.5			$\mu\text{V}_{\text{P-P}}$
$e_n$	Input Noise Voltage Density	$f = 1\text{kHz}$		14		14			$\text{nV}/\sqrt{\text{Hz}}$
$i_n$	Input Noise Current Density	$f = 1\text{kHz}$		0.03		0.03			$\text{pA}/\sqrt{\text{Hz}}$
$R_{\text{IN}}$	Input Resistance	Differential Mode	●	20		20			$\text{M}\Omega$
		Common Mode	●	100		100			$\text{G}\Omega$
$C_{\text{IN}}$	Input Capacitance		●	2		2			$\text{pF}$
$V_{\text{CM}}$	Input Voltage Range		●	$V^- + 1.0$	$V^+ - 1.0$	$V^- + 1.0$	$V^+ - 1.0$		V
			●	$V^- + 1.2$	$V^+ - 1.2$	$V^- + 1.2$	$V^+ - 1.2$		V
CMRR	Common Mode Rejection Ratio	$-13.5\text{V} < V_{\text{CM}} < 13.5\text{V}$	●	114	130	110	130		dB
+PSRR	Positive Power Supply Rejection Ratio	$V^- = -15\text{V}$ , $V_{\text{CM}} = 0\text{V}$ ; $1.5\text{V} < V^+ < 18\text{V}$	●	110	132	108	132		dB
-PSRR	Negative Power Supply Rejection Ratio	$V^+ = 15\text{V}$ , $V_{\text{CM}} = 0\text{V}$ ; $-1.5\text{V} < V^- < -18\text{V}$	●	106	132	104	132		dB
	Minimum Operating Supply Voltage		●	$\pm 1.2$	$\pm 1.35$	$\pm 1.2$	$\pm 1.35$		V
$A_{\text{VOL}}$	Large-Signal Voltage Gain	$R_L = 10\text{k}$ ; $-13.5\text{V} < V_{\text{OUT}} < 13.5\text{V}$	●	1000	1600	1000	1600		V/mV
			●	700		500			V/mV
		$R_L = 2\text{k}$ ; $-13.5\text{V} < V_{\text{OUT}} < 4\text{V}$	●	175	420	175	420		V/mV
			●	125		110		V/mV	
		$R_L = 1\text{k}$ ; $1\text{V} < V_{\text{OUT}} < 4\text{V}$	●	90	230	90	230		V/mV
			●	65		7		V/mV	
$V_{\text{OL}}$	Output Voltage Swing Low (Referred to $V_{\text{EE}}$ )	No Load	●	20	40	20	50		mV
		$I_{\text{SINK}} = 100\mu\text{A}$	●	25	50	25	60		mV
		$I_{\text{SINK}} = 1\text{mA}$	●	70	150	70	200		mV
		$I_{\text{SINK}} = 5\text{mA}$	●	270	600	270	750		mV
$V_{\text{OH}}$	Output Voltage Swing High (Referred to $V_{\text{CC}}$ )	No Load	●	120	220	120	300		mV
		$I_{\text{SOURCE}} = 100\mu\text{A}$	●	130	230	130	325		mV
		$I_{\text{SOURCE}} = 1\text{mA}$	●	180	300	180	450		mV
		$I_{\text{SOURCE}} = 5\text{mA}$	●	360	600	360	800		mV
$I_S$	Supply Current Per Amplifier	$V_S = \pm 15\text{V}$	●	0.5	0.85	1.1	0.85	1.1	mA
								2.0	mA
$I_{\text{SC}}$	Short-Circuit Current	$V_{\text{OUT}}$ Short to $V^-$	●	20	40	20	40		mA
			●	15	40	10	40		mA
		$V_{\text{OUT}}$ Short to $V^+$	●	20	30	20	30		mA
			●	15	30	10	30		mA
GBW	Gain Bandwidth Product	$f = 20\text{kHz}$		0.4	0.85	0.4	0.85		MHz
	Channel Separation	$f = 1\text{kHz}$		120		120			dB
$t_S$	Settling Time	0.01%, $V_{\text{OUT}} = -5\text{V}$ to $5\text{V}$ , $A_V = -1$ , $R_L = 2\text{k}$		30		30			$\mu\text{s}$
$\text{SR}^+$	Slew Rate Positive	$A_V = -1$	●	0.21	0.4	0.21	0.4		V/ $\mu\text{s}$
				0.18		0.15			V/ $\mu\text{s}$
$\text{SR}^-$	Slew Rate Negative	$A_V = -1$	●	0.13	0.20	0.11	0.20		V/ $\mu\text{s}$
			●	0.1		0.07			V/ $\mu\text{s}$

**ELECTRICAL CHARACTERISTICS** The ● denotes the specifications which apply over the full operating temperature range, otherwise specifications are at  $T_A = 25^\circ\text{C}$ . Split supply operation  $V_S = \pm 15\text{V}$ ,  $V_{CM} = 0\text{V}$  unless otherwise noted. (Note 5)

SYMBOL	PARAMETER	CONDITIONS	C/I Grades			H/MP Grades			UNITS
			MIN	TYP	MAX	MIN	TYP	MAX	
FPBW	Full-Power Bandwidth	$V_{OUT} = 28V_{P-P}$ (Note 10)	● 1.47 1.13	2.25		1.47 0.79	2.25		kHz kHz
$\Delta V_{OS}$	Offset Voltage Match (LT1881A)	(Note 7)	●	35	70				$\mu\text{V}$
		$0^\circ\text{C} < T_A < 70^\circ\text{C}$	●		125				$\mu\text{V}$
		$-40^\circ\text{C} < T_A < 85^\circ\text{C}$	●		160				$\mu\text{V}$
	Offset Voltage Match (LT1881/LT1882)	(Note 7)	●	42	125	42	125		$\mu\text{V}$
		$0^\circ\text{C} < T_A < 70^\circ\text{C}$	●		175				$\mu\text{V}$
		$-40^\circ\text{C} < T_A < 85^\circ\text{C}$	●		235				$\mu\text{V}$
		$-40^\circ\text{C} < T_A < 125^\circ\text{C}$	●					435	$\mu\text{V}$
		$-55^\circ\text{C} < T_A < 125^\circ\text{C}$	●					435	$\mu\text{V}$
	Offset Voltage Match Drift	(Notes 6, 7)	●	0.4	1.1	0.4	1.1		$\mu\text{V}/^\circ\text{C}$
$\Delta I_{B+}$	Noninverting Bias Current Match (LT1881A)	(Note 7)	●	200	300				$\text{pA}$
		$0^\circ\text{C} < T_A < 70^\circ\text{C}$	●		400				$\text{pA}$
		$-40^\circ\text{C} < T_A < 85^\circ\text{C}$	●		500				$\text{pA}$
$\Delta I_{B+}$	Noninverting Bias Current Match (LT1881/LT1882)	(Note 7)	●	250	700	250	700		$\text{pA}$
		$0^\circ\text{C} < T_A < 70^\circ\text{C}$	●		900				$\text{pA}$
		$-40^\circ\text{C} < T_A < 85^\circ\text{C}$	●		1000				$\text{pA}$
		$-40^\circ\text{C} < T_A < 125^\circ\text{C}$	●					2000	$\text{pA}$
		$-55^\circ\text{C} < T_A < 125^\circ\text{C}$	●					2000	$\text{pA}$
$\Delta\text{CMRR}$	Common Mode Rejection Match	(Notes 7, 9)	●	110	125	106	125		dB
$\Delta+\text{PSRR}$	Positive Power Supply Rejection Ratio Match	$V^- = -15\text{V}$ , $V_{CM} = 0\text{V}$ , $1.5\text{V} < V^+ < 18\text{V}$ , (Notes 7, 9)	●	108	130	108	130		dB
$\Delta-\text{PSRR}$	Negative Power Supply Rejection Ratio Match	$V^+ = 15\text{V}$ , $V_{CM} = 0\text{V}$ , $-1.5\text{V} < V^- < -18\text{V}$ , (Notes 7, 9)	●	104	130	104	130		dB

**Note 1:** Stresses beyond those listed under Absolute Maximum Ratings may cause permanent damage to the device. Exposure to any Absolute Maximum Rating condition for extended periods may affect device reliability and lifetime.

**Note 2:** The inputs are protected by internal resistors and back-to-back diodes. If the differential input voltage exceeds  $\pm 0.7\text{V}$ , the input current should be limited externally to less than 10mA.

**Note 3:** A heat sink may be required to keep the junction temperature below absolute maximum.

**Note 4:** The LT1881C/LT1882C and LT1881I/LT1882I are guaranteed functional over the operating temperature range of  $-40^\circ\text{C}$  to  $85^\circ\text{C}$ . The LT1882H is guaranteed functional over the operating temperature range  $-40^\circ\text{C}$  to  $125^\circ\text{C}$ . The LT1882MP is guaranteed functional over the operating temperature range  $-55^\circ\text{C}$  to  $125^\circ\text{C}$ .

**Note 5:** The LT1881C/LT1882C are guaranteed to meet specified performance from  $0^\circ\text{C}$  to  $70^\circ\text{C}$ . The LT1881C/LT1882C are designed, characterized and expected to meet specified performance from  $-40^\circ\text{C}$  to  $85^\circ\text{C}$  but are not tested or QA sampled at these temperatures. The LT1881I/LT1882I are guaranteed to meet specified performance from  $-40^\circ\text{C}$  to  $85^\circ\text{C}$ . The LT1882H is guaranteed to meet specified performance from  $-40^\circ\text{C}$  to  $125^\circ\text{C}$ . The LT1882MP is guaranteed to meet specified performance from  $-55^\circ\text{C}$  to  $125^\circ\text{C}$ .

**Note 6:** This parameter is not 100% tested.

**Note 7:** Matching parameters are the difference between amplifiers A and B in the LT1881; and between amplifiers A and D and B and C in the LT1882.

**Note 8:** This parameter is the difference between the two noninverting input bias currents.

**Note 9:**  $\Delta\text{CMRR}$  and  $\Delta\text{PSRR}$  are defined as follows: CMRR and PSRR are measured in  $\mu\text{V}/\text{V}$  on each amplifier. The difference is calculated in  $\mu\text{V}/\text{V}$  and then converted to dB.

**Note 10:** Full power bandwidth is calculated from the slew rate:  $\text{FPBW} = \text{SR}/2\pi V_P$ .

## TYPICAL PERFORMANCE CHARACTERISTICS

**Supply Current per Amplifier vs Supply Voltage**

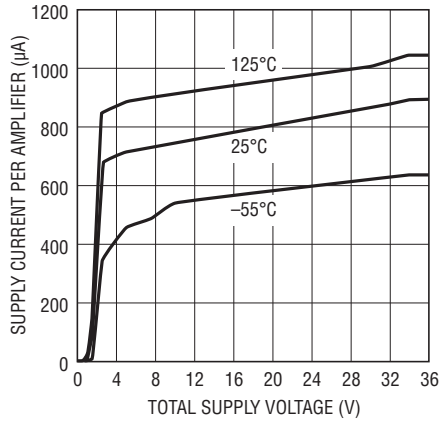

18812 G01

**Slew Rate vs Supply Voltage**

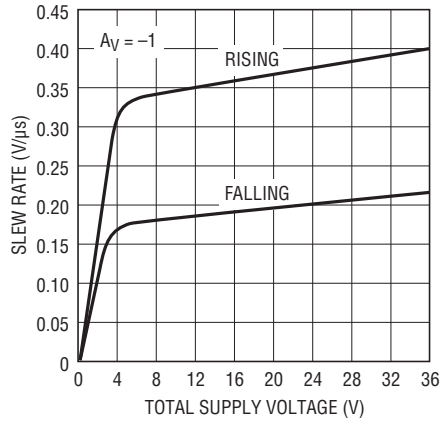

18812 G02

**Slew Rate vs Temperature**

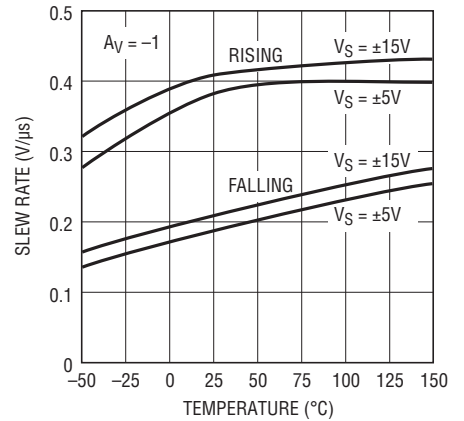

18812 G03

**Settling Time vs Output Step**

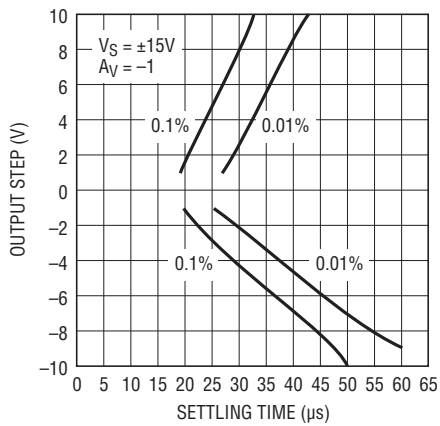

18812 G04

**Settling Time vs Output Step**

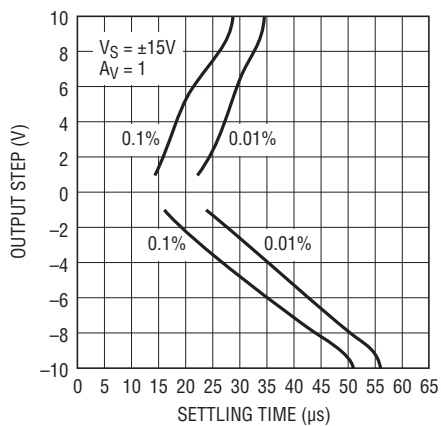

18812 G05

**Gain Bandwidth Product vs Supply Voltage**

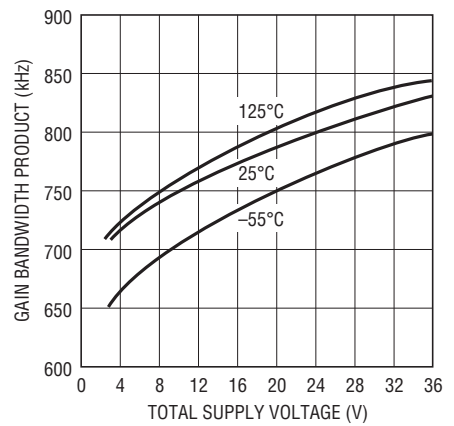

18812 G06

**Phase Margin vs Supply Voltage**

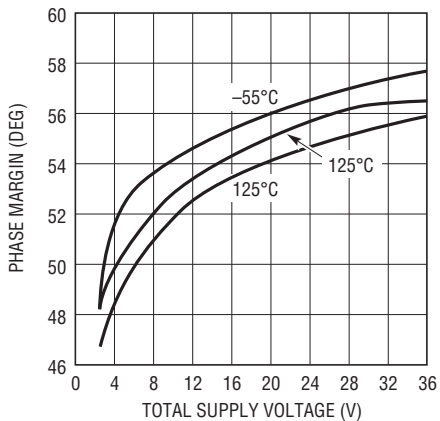

18812 G07

**Gain vs Frequency, Av = -1**

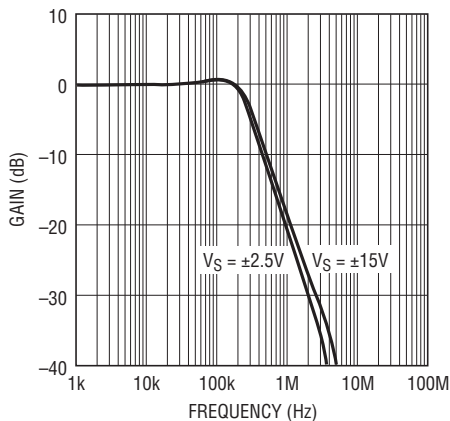

18812 G08

**Gain vs Frequency, Av = 1**

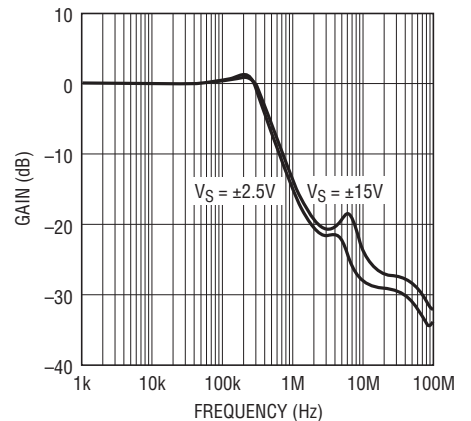

18812 G09



TYPICAL PERFORMANCE CHARACTERISTICS

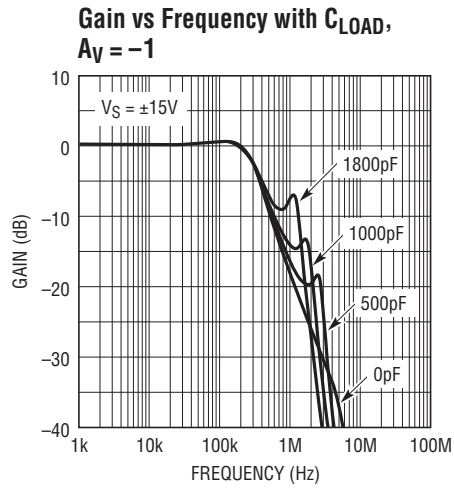
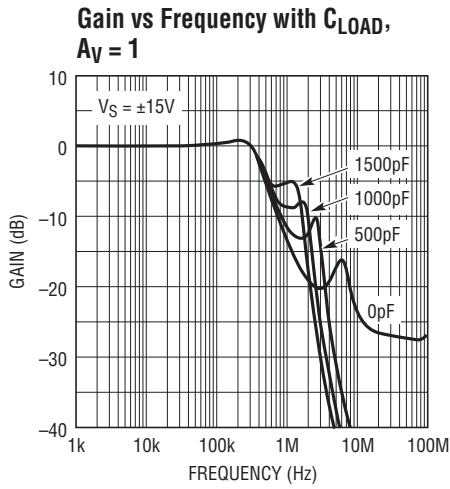

**Large Signal Response,  $A_V = -1$**

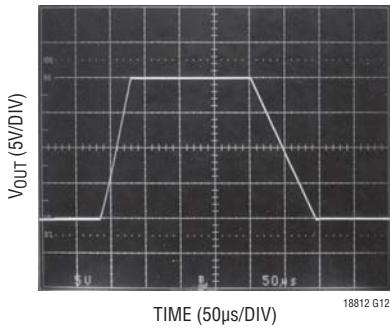

**Large Signal Response,  $A_V = 1$**

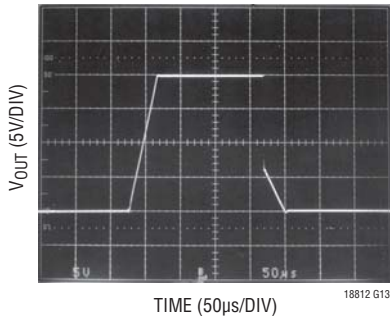

**Small Signal Response,  $A_V = -1$ , No Load**

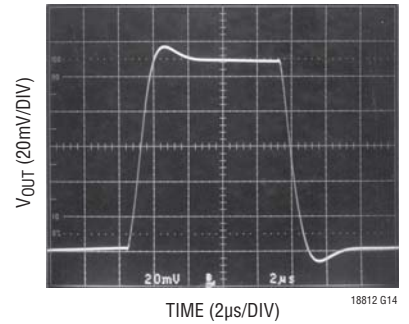

**Small Signal Response,  $A_V = -1$ ,  $C_L = 1000pF$**

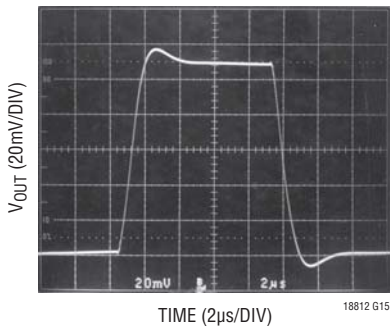

**Small Signal Response,  $A_V = 1$ ,  $R_L = 2k$**

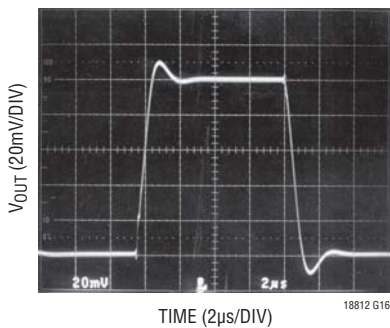

**Small Signal Response,  $A_V = 1$ ,  $C_L = 500pF$**

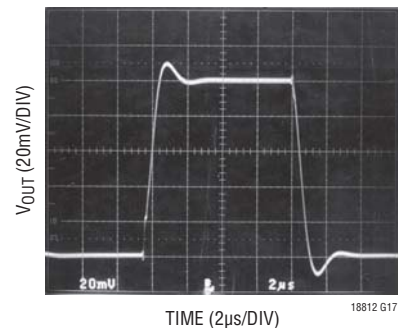

## TYPICAL PERFORMANCE CHARACTERISTICS

**$V_{OS}$  Distribution,  $T_A = 25^\circ\text{C}$**

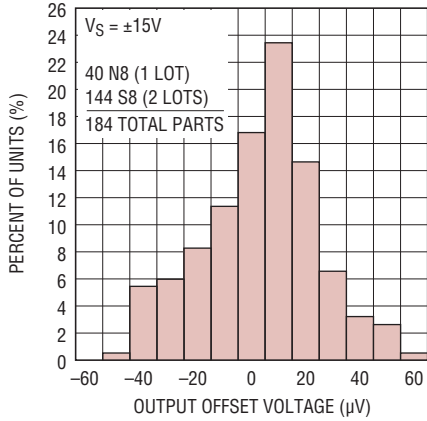

18812 G18

**Voltage Offset vs Temperature**

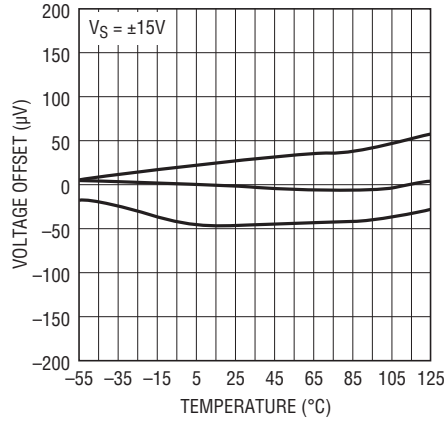

18812 G19

**Warm-Up Drift vs Time**

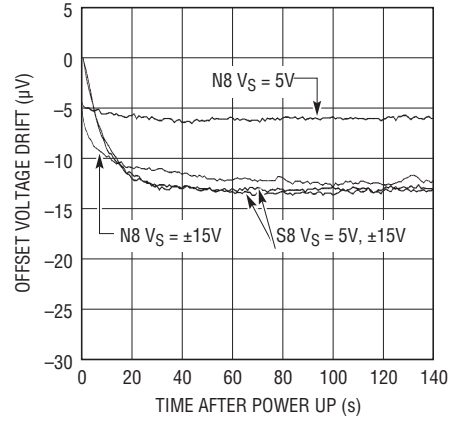

18812 G20

**Input Bias Current vs Common Mode Voltage**

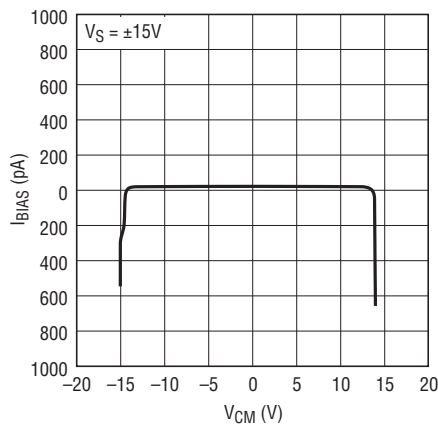

18812 G21

**Input Bias Current vs Temperature**

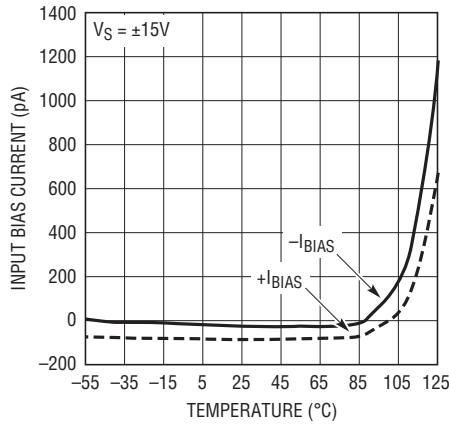

18812 G22

**Input Common Mode Range vs Supply Voltage**

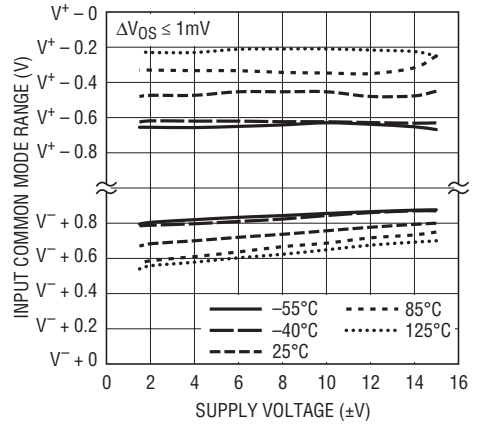

18812 G23

**Input Common Mode Range vs Temperature**

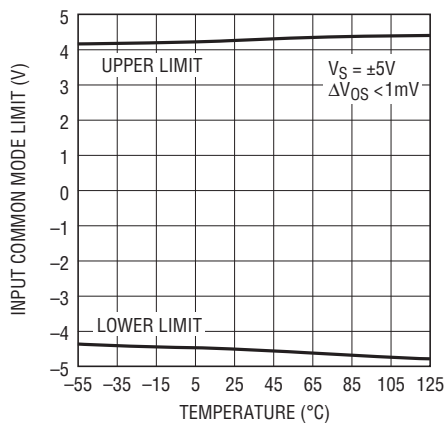

18812 G24

**Output Voltage Swing vs Supply Voltage**

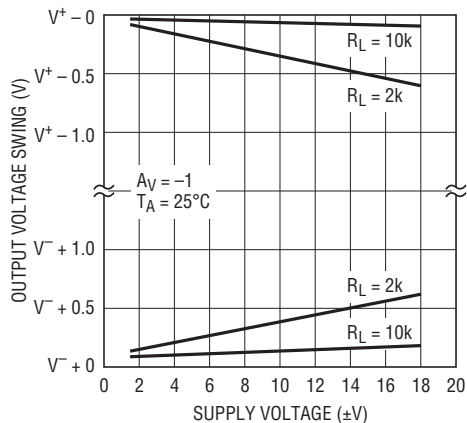

18812 G25

**Output Saturation Voltage vs Load Current (Output High)**

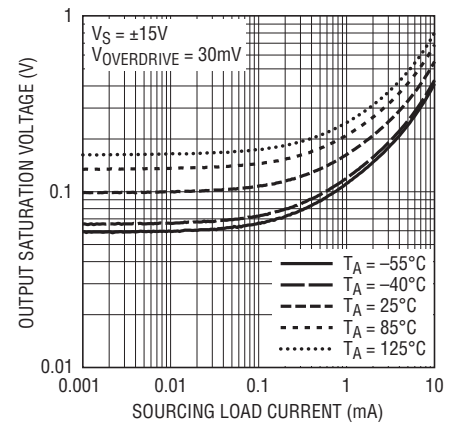

18812 G26

# TYPICAL PERFORMANCE CHARACTERISTICS

**Output Saturation Voltage vs Load Current (Output Low)**

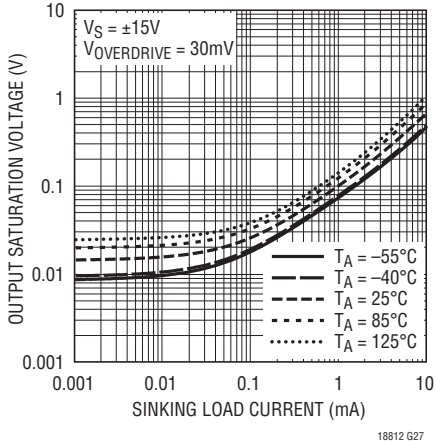

**Output Short-Circuit Current vs Temperature**

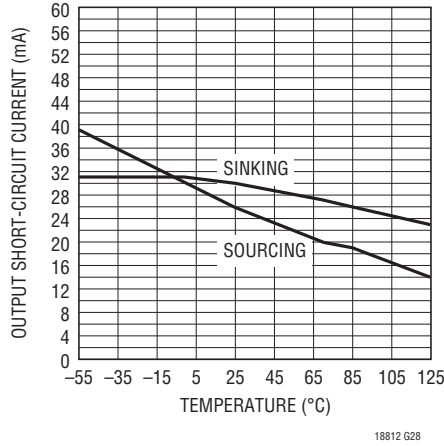

**Output Voltage vs Large Input Voltage**

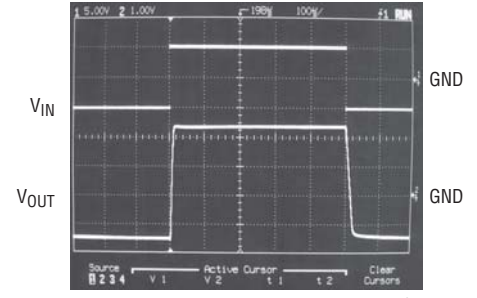

$A_V = 1$   
 $V_S = \pm 2.5V$   
 $V_{IN} = \pm 5V$   
 $R_{IN} = 10k$

**Open-Loop Gain vs Frequency**

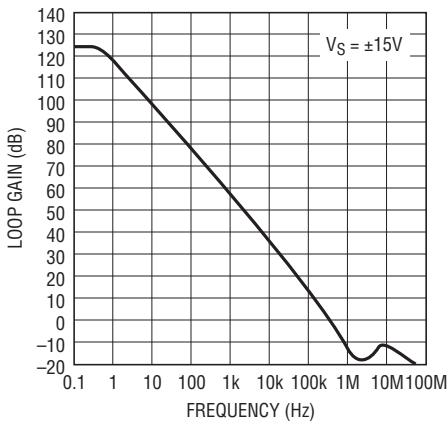

**Open-Loop Gain and Phase vs Frequency**

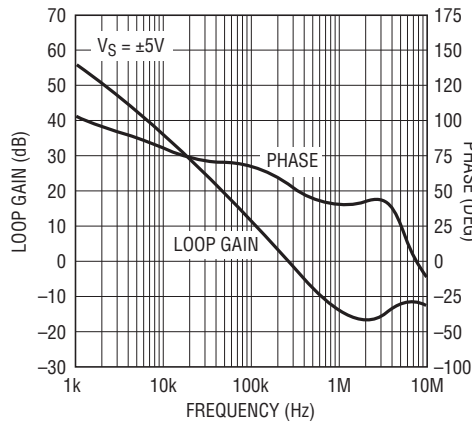

**Channel Separation vs Frequency**

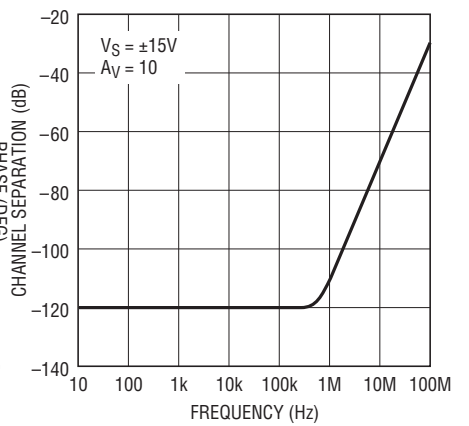

**Gain Bandwidth Product vs Temperature**

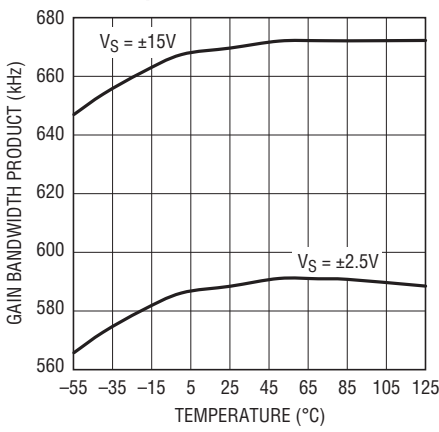

**Output Impedance vs Frequency**

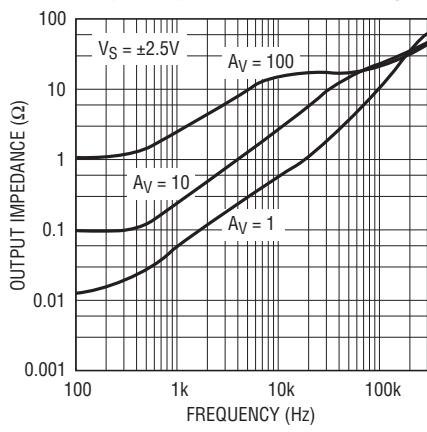

**PSRR vs Frequency**

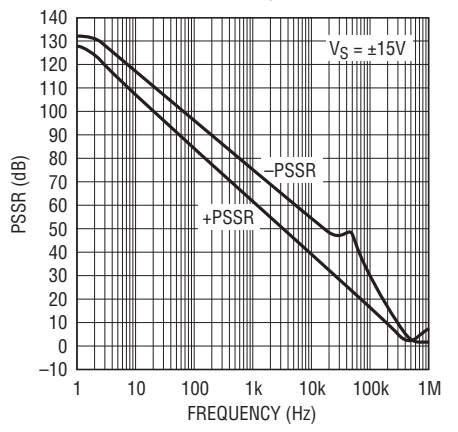

## TYPICAL PERFORMANCE CHARACTERISTICS

**Common Mode Rejection Ratio vs Frequency**

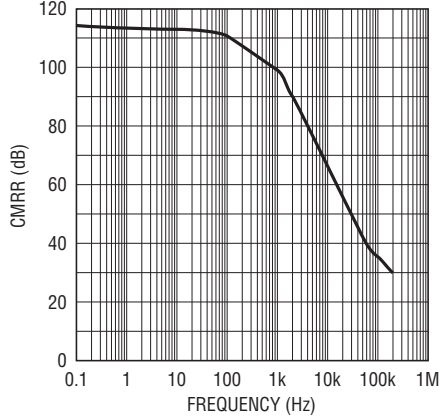

**0.1Hz to 10Hz Noise**

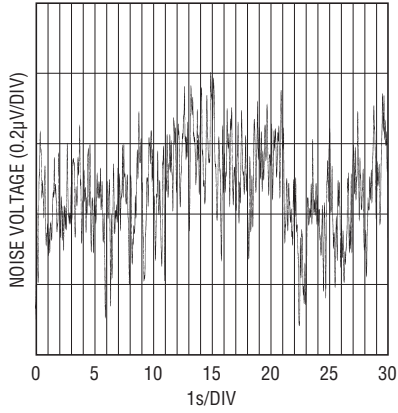

**Noise Voltage vs Frequency**

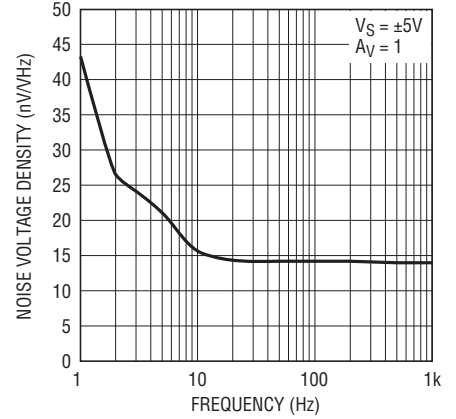

**Noise Current Density vs Frequency**

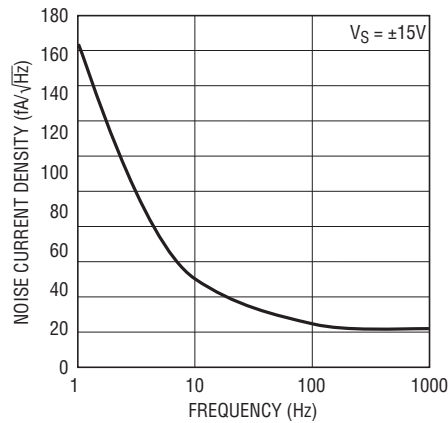

**Total Noise vs Source Resistance**

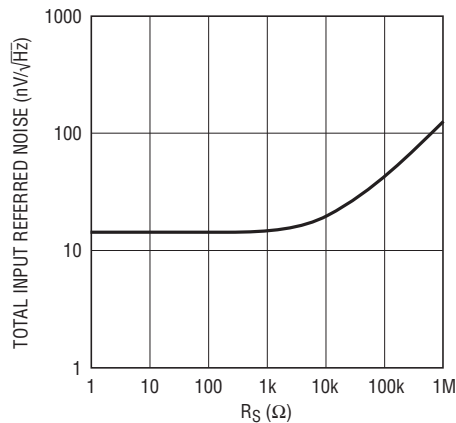

**Overshoot vs Capacitive Load**

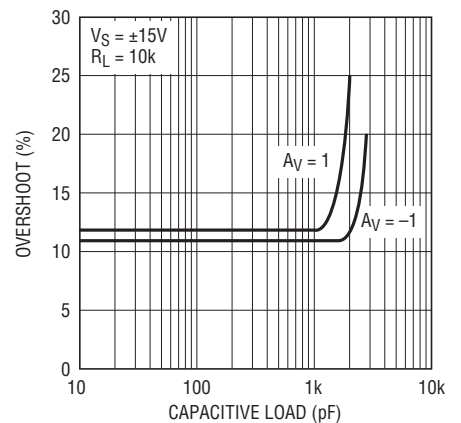

**Series Output Resistance vs Capacitive Load**

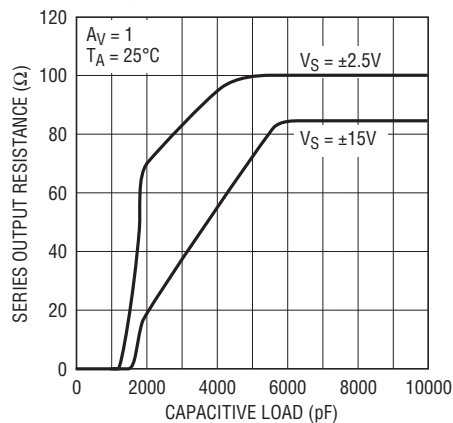

**Undistorted Output Swing vs Frequency**

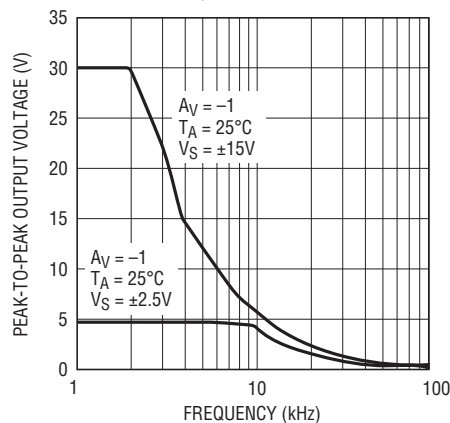

**THD + Noise vs Frequency**

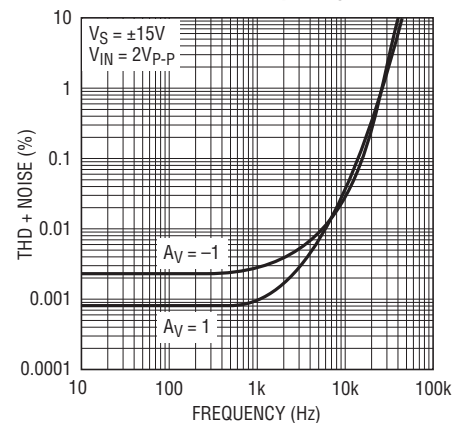

# TYPICAL PERFORMANCE CHARACTERISTICS

**Total Harmonic Distortion + Noise vs Output Voltage Amplitude**

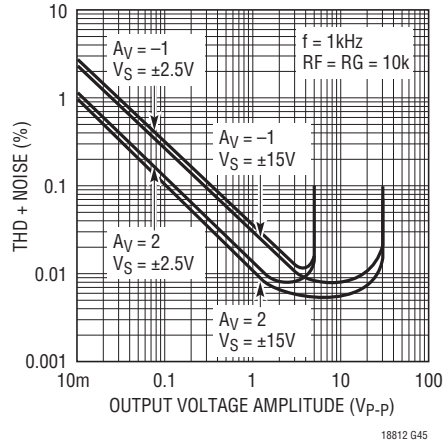

**Open-Loop Gain**

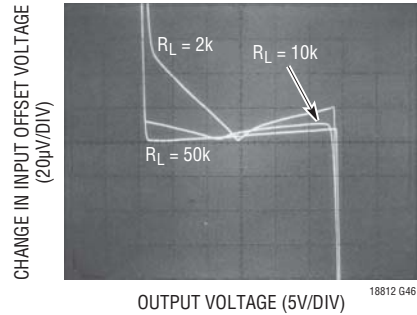

**Settling Time/Output Step 0.01%**

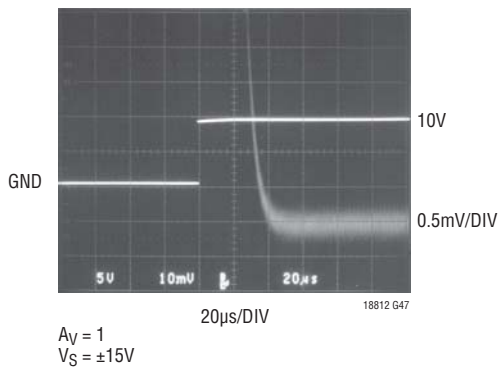

**Settling Time/Output Step 0.01%**

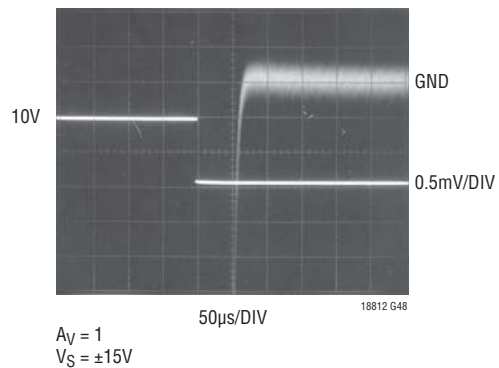

**Gain vs Temperature**

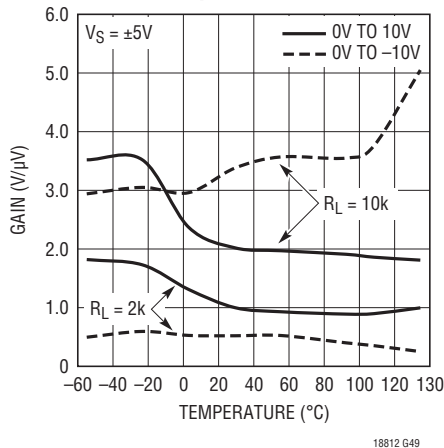

**Gain vs Load Resistance**

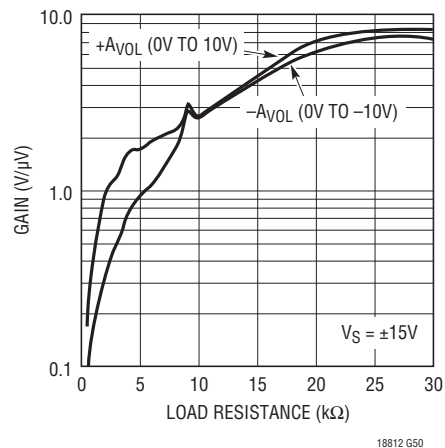

## APPLICATIONS INFORMATION

The LT1881 dual and LT1882 quad op amps feature exceptional input precision with rail-to-rail output swing. The amplifiers are similar to the LT1884 and LT1885 devices. The LT1881 and LT1882 offer superior capacitive load driving capabilities over the LT1884 and LT1885 in low voltage gain configurations. Offset voltages are trimmed to less than  $50\mu\text{V}$  and input bias currents are less than  $200\text{pA}$  on the “A” grade devices. Obtaining beneficial advantage of these precision input characteristics depends upon proper applications circuit design and board layout.

### Preserving Input Precision

Preserving the input voltage accuracy of the LT1881/LT1882 requires that the applications circuit and PC board layout do not introduce errors comparable to or greater than the  $30\mu\text{V}$  offset. Temperature differentials across the input connections can generate thermocouple voltages of 10's of microvolts. PC board layouts should keep connections to the amplifier's input pins close together and away from heat dissipating components. Air currents across the board can also generate temperature differentials.

The extremely low input bias currents,  $150\text{pA}$ , allow high accuracy to be maintained with high impedance sources and feedback networks. The LT1881/LT1882's low input bias currents are obtained by using a cancellation circuit on-chip. This causes the resulting  $I_{\text{BIAS}+}$  and  $I_{\text{BIAS}-}$  to be uncorrelated, as implied by the  $I_{\text{OS}}$  specification being greater than the  $I_{\text{BIAS}}$ . The user should not try to balance the input resistances in each input lead, as is commonly recommended with most amplifiers. The impedance at either input should be kept as small as possible to minimize total circuit error.

PC board layout is important to insure that leakage currents do not corrupt the low  $I_{\text{BIAS}}$  of the amplifier. In high precision, high impedance circuits, the input pins should be surrounded by a guard ring of PC board interconnect, with the guard driven to the same common mode voltage as the amplifier inputs.

### Input Common Mode Range

The LT1881 and LT1882 outputs are able to swing nearly to each power supply rail, but the input stage is limited to operating between  $V^- + 1\text{V}$  and  $V^+ - 1\text{V}$ . Exceeding this common mode range will cause the gain to drop to zero; however, no phase reversal will occur.

### Input Protection

The inverting and noninverting input pins of the LT1881 and LT1882 have limited on-chip protection. ESD protection is provided to prevent damage during handling. The input transistors have voltage clamping and limiting resistors to protect against input differentials up to 10V. Short transients above this level will also be tolerated. If the input pins can see a sustained differential voltage above 10V, external limiting resistors should be used to prevent damage to the amplifier. A 1k resistor in each input lead will provide protection against a 30V differential voltage.

### Capacitive Loads

The LT1881 and LT1882 can drive capacitive loads up to  $1000\text{pF}$  in unity-gain. The capacitive load driving increases as the amplifier is used in higher gain configurations. Capacitive load driving may be increased by decoupling the capacitance from the output with a small resistance.

# PACKAGE DESCRIPTION

**N8 Package**  
**8-Lead PDIP (Narrow 0.300)**  
 (LTC DWG # 05-08-1510)

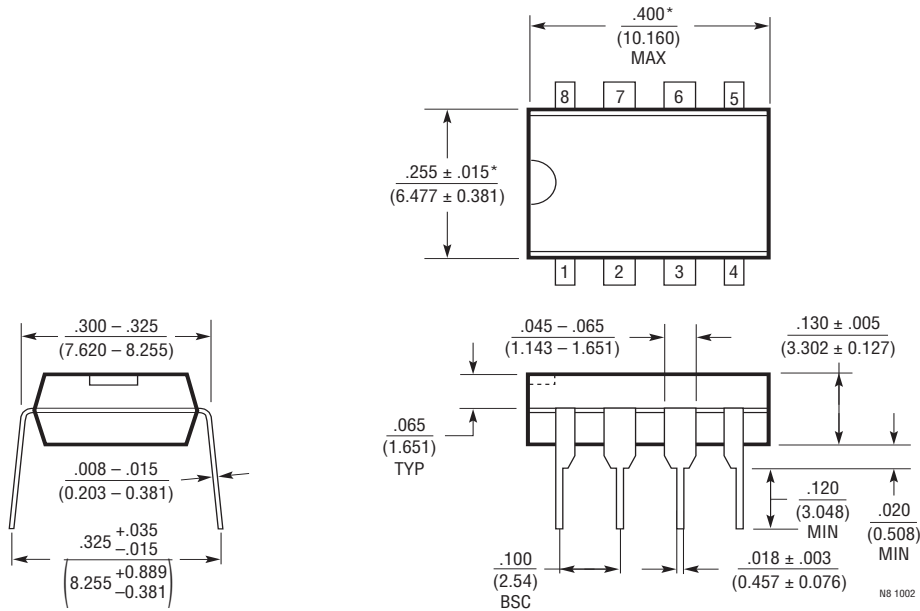

NOTE:  
 1. DIMENSIONS ARE  $\frac{\text{INCHES}}{\text{MILLIMETERS}}$   
 \*THESE DIMENSIONS DO NOT INCLUDE MOLD FLASH OR PROTRUSIONS.  
 MOLD FLASH OR PROTRUSIONS SHALL NOT EXCEED .010 INCH (0.254mm)

**PACKAGE DESCRIPTION**

**S8 Package**  
**8-Lead Plastic Small Outline (Narrow 0.150)**  
 (LTC DWG # 05-08-1610)

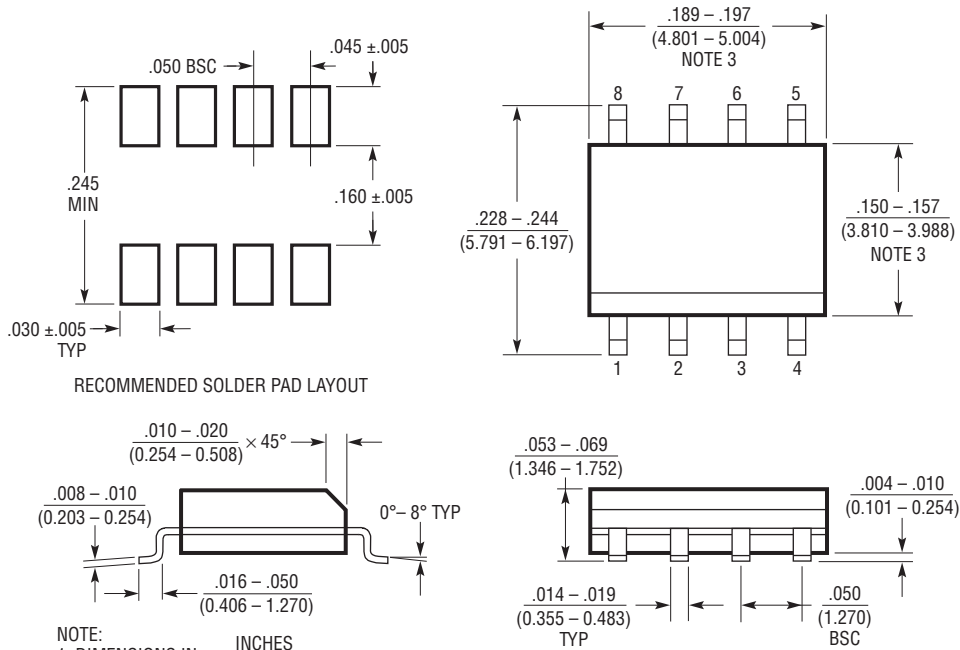

- NOTE:  
 1. DIMENSIONS IN  $\frac{\text{INCHES}}{\text{MILLIMETERS}}$   
 2. DRAWING NOT TO SCALE  
 3. THESE DIMENSIONS DO NOT INCLUDE MOLD FLASH OR PROTRUSIONS.  
 MOLD FLASH OR PROTRUSIONS SHALL NOT EXCEED  $.006''$  (0.15mm)

S08 0303



# PACKAGE DESCRIPTION

## S Package 14-Lead Plastic Small Outline (Narrow 0.150) (LTC DWG # 05-08-1610)

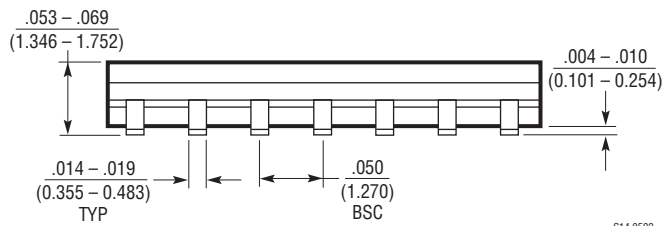
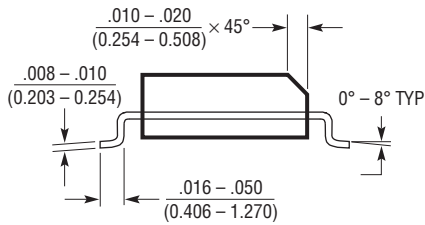
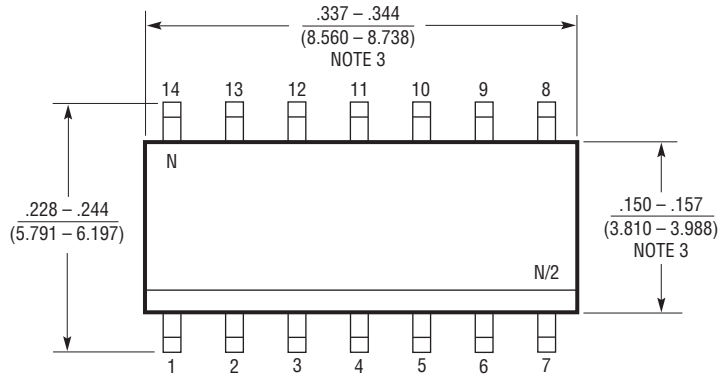
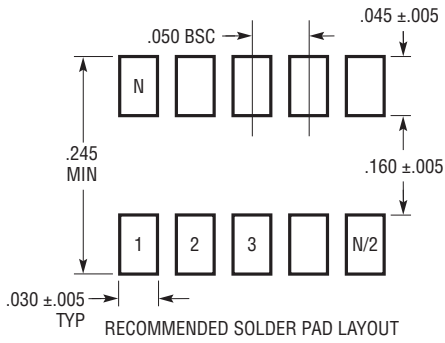

- NOTE:  
 1. DIMENSIONS IN  $\frac{\text{INCHES}}{\text{(MILLIMETERS)}}$   
 2. DRAWING NOT TO SCALE  
 3. THESE DIMENSIONS DO NOT INCLUDE MOLD FLASH OR PROTRUSIONS.  
 MOLD FLASH OR PROTRUSIONS SHALL NOT EXCEED .006" (0.15mm)

S14 0502

# LT1881/LT1882

## TYPICAL APPLICATION

-50°C to 600°C Digital Thermometer Operates on 3.3V

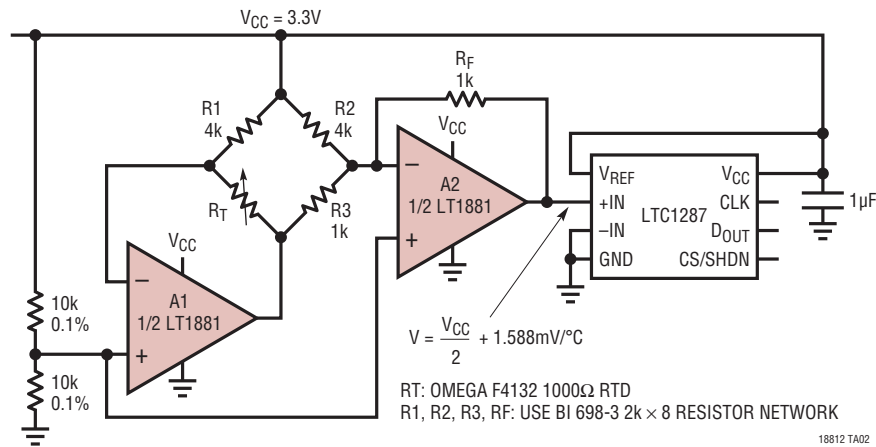

## RELATED PARTS

PART NUMBER	DESCRIPTION	COMMENTS
LT1112/LT1114	Dual/Quad Picoamp Input Op Amps	$V_{OS} = 60\mu\text{V}$ Max
LT1167	Gain Programmable Instrumentation Amp	Gain Error = 0.08% Max
LT1677	Low Noise, Rail-to-Rail Precision Op Amp	$e_n = 3.2\text{nV}/\sqrt{\text{Hz}}$
LT1793	Low Noise JFET Op Amp	$I_B = 10\text{pA}$ Max
LT1880	SOT-23 Picoamp Input Precision Op Amp	150μV Max $V_{OS}$ , -40°C to 85°C Operation Guaranteed, SOT-23 Package
LT1884/LT1885	Dual/Quad Picoamp Input Op Amps	3 Times Faster than LT1881/LT1882
LTC2050	Zero Drift Op Amp in SOT-23	$V_{OS} = 3\mu\text{V}$ Max, Rail-to-Rail Output
LTC6011/LTC6012	Dual/Quad 135μA Rail-to-Rail Output Precision Op Amps	Lower Power, Available in DFN Package
LTC6081/LTC6082	Dual/Quad Precision CMOS Op Amps	$I_B = 1\text{pA}$ Max, $V_{OS} = 70\mu\text{V}$ Max

18812fb