

Single Resistor Gain Programmable, Precision Instrumentation Amplifier

FEATURES

- **Single Gain Set Resistor: $G = 1$ to 10,000**
- **Gain Error: $G = 10$, 0.3% Max**
- Gain Nonlinearity: $G = 10$, 30ppm Max
- Input Offset Voltage: $G = 10$, 225 μ V Max
- **Input Offset Voltage Drift: 1 μ V/ $^{\circ}$ C Max**
- Input Bias Current: 2nA Max
- PSRR at $G = 1$: 80dB Min
- CMRR at $G = 1$: 75dB Min
- Supply Current: 1.3mA Max
- Wide Supply Range: $\pm 2.3V$ to $\pm 18V$
- 1kHz Voltage Noise: 7.5nV/ $\sqrt{\text{Hz}}$
- 0.1Hz to 10Hz Noise: 0.28 μ V_{P-P}
- Available in 8-Pin PDIP and SO Packages
- **Meets IEC 1000-4-2 Level 4 ESD Tests with Two External 5k Resistors**

APPLICATIONS

- Bridge Amplifiers
- Strain Gauge Amplifiers
- Thermocouple Amplifiers
- Differential to Single-Ended Converters
- Medical Instrumentation

DESCRIPTION

The LT[®]1920 is a low power, precision instrumentation amplifier that requires only one external resistor to set gains of 1 to 10,000. The low voltage noise of 7.5nV/ $\sqrt{\text{Hz}}$ (at 1kHz) is not compromised by low power dissipation (0.9mA typical for $\pm 2.3V$ to $\pm 15V$ supplies).

The high accuracy of 30ppm maximum nonlinearity and 0.3% max gain error ($G = 10$) is not degraded even for load resistors as low as 2k (previous monolithic instrumentation amps used 10k for their nonlinearity specifications). The LT1920 is laser trimmed for very low input offset voltage (125 μ V max), drift (1 μ V/ $^{\circ}$ C), high CMRR (75dB, $G = 1$) and PSRR (80dB, $G = 1$). Low input bias currents of 2nA max are achieved with the use of superbeta processing. The output can handle capacitive loads up to 1000pF in any gain configuration while the inputs are ESD protected up to 13kV (human body). The LT1920 with two external 5k resistors passes the IEC 1000-4-2 level 4 specification.

The LT1920, offered in 8-pin PDIP and SO packages, is a pin for pin and spec for spec improved replacement for the AD620. The LT1920 is the most cost effective solution for precision instrumentation amplifier applications. For even better guaranteed performance, see the LT1167.

 LTC and LT are registered trademarks of Linear Technology Corporation.

TYPICAL APPLICATION

Single Supply Barometer

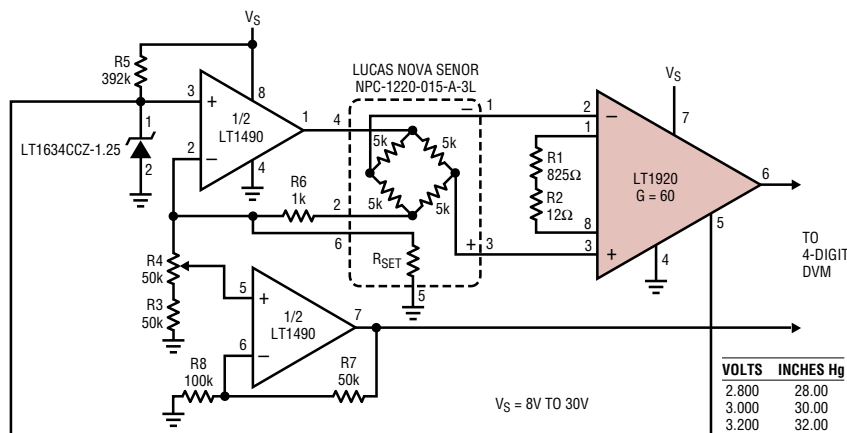

Gain Nonlinearity

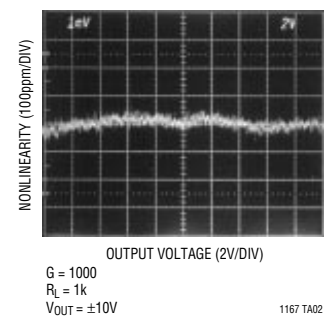

ABSOLUTE MAXIMUM RATINGS

(Note 1)

Supply Voltage	±20V
Differential Input Voltage (Within the Supply Voltage)	±40V
Input Voltage (Equal to Supply Voltage)	±20V
Input Current (Note 3)	±20mA
Output Short-Circuit Duration	Indefinite
Operating Temperature Range	-40°C to 85°C
Specified Temperature Range	
LT1920C (Note 4)	0°C to 70°C
LT1920I	-40°C to 85°C
Storage Temperature Range	-65°C to 150°C
Lead Temperature (Soldering, 10 sec)	300°C

PACKAGE/ORDER INFORMATION

ORDER PART NUMBER
LT1920CN8 LT1920CS8 LT1920IN8 LT1920IS8
S8 PART MARKING
1920 1920I

Consult factory for Military grade parts.

ELECTRICAL CHARACTERISTICS $V_S = \pm 15V$, $V_{CM} = 0V$, $T_A = 25^\circ C$, $R_L = 2k$, unless otherwise noted.

SYMBOL	PARAMETER	CONDITIONS (Note 6)	MIN	TYP	MAX	UNITS
G	Gain Range	$G = 1 + (49.4k/R_G)$	1		10k	
	Gain Error	$G = 1$		0.008	0.1	%
		$G = 10$ (Note 2)		0.010	0.3	%
		$G = 100$ (Note 2)		0.025	0.3	%
		$G = 1000$ (Note 2)		0.040	0.35	%
G/T	Gain vs Temperature	$G < 1000$ (Note 2)		20	50	ppm/°C
	Gain Nonlinearity (Note 5)	$V_O = \pm 10V$, $G = 1$		10		ppm
$V_O = \pm 10V$, $G = 10$ and 100			10	30	ppm	
$V_O = \pm 10V$, $G = 100$ and 1000			20		ppm	
V_{OST}	Total Input Referred Offset Voltage	$V_{OST} = V_{OSI} + V_{OSO}/G$				
V_{OSI}	Input Offset Voltage	$G = 1000$, $V_S = \pm 5V$ to $\pm 15V$		30	125	μV
		$G = 1000$, $V_S = \pm 5V$ to $\pm 15V$			185	μV
V_{OSI}/T	Input Offset Drift (RTI)	(Note 3)			1	μV/°C
V_{OSO}	Output Offset Voltage	$G = 1$, $V_S = \pm 5V$ to $\pm 15V$		400	1000	μV
		$G = 1$, $V_S = \pm 5V$ to $\pm 15V$			1500	μV
V_{OSO}/T	Output Offset Drift	(Note 3)		5	15	μV/°C
I_{OS}	Input Offset Current			0.3	1	nA
I_B	Input Bias Current			0.5	2	nA
e_n	Input Noise Voltage, RTI	0.1Hz to 10Hz, $G = 1$		2.00		μV _{P-P}
		0.1Hz to 10Hz, $G = 10$		0.50		μV _{P-P}
		0.1Hz to 10Hz, $G = 100$ and 1000		0.28		μV _{P-P}
Total RTI Noise = $\sqrt{e_{ni}^2 + (e_{no}/G)^2}$						
e_{ni}	Input Noise Voltage Density, RTI	$f_0 = 1kHz$		7.5		nV/√Hz
e_{no}	Output Noise Voltage Density, RTI	$f_0 = 1kHz$		67		nV/√Hz
i_n	Input Noise Current	$f_0 = 0.1Hz$ to 10Hz		10		pA _{P-P}
	Input Noise Current Density	$f_0 = 10Hz$		124		fA/√Hz
R_{IN}	Input Resistance	$V_{IN} = \pm 10V$		200		GΩ
$C_{IN(DIFF)}$	Differential Input Capacitance	$f_0 = 100kHz$		1.6		pF

ELECTRICAL CHARACTERISTICS $V_S = \pm 15V$, $V_{CM} = 0V$, $T_A = 25^\circ C$, $R_L = 2k$, unless otherwise noted.

SYMBOL	PARAMETER	CONDITIONS (Note 6)	MIN	TYP	MAX	UNITS
$C_{IN(CM)}$	Common Mode Input Capacitance	$f_0 = 100kHz$		1.6		pF
V_{CM}	Input Voltage Range	$G = 1$, Other Input Grounded $V_S = \pm 2.3V$ to $\pm 5V$ $V_S = \pm 5V$ to $\pm 18V$ $V_S = \pm 2.3V$ to $\pm 5V$ $V_S = \pm 5V$ to $\pm 18V$	$-V_S + 1.9$ $-V_S + 1.9$ $-V_S + 2.1$ $-V_S + 2.1$		$+V_S - 1.2$ $+V_S - 1.4$ $+V_S - 1.3$ $+V_S - 1.4$	V V V V
CMRR	Common Mode Rejection Ratio	1k Source Imbalance, $V_{CM} = 0V$ to $\pm 10V$ $G = 1$ $G = 10$ $G = 100$ $G = 1000$	75 95 110 110	95 115 125 140		dB dB dB dB
PSRR	Power Supply Rejection Ratio	$V_S = \pm 2.3$ to $\pm 18V$ $G = 1$ $G = 10$ $G = 100$ $G = 1000$	80 100 120 120	120 135 140 150		dB dB dB dB
I_S	Supply Current	$V_S = \pm 2.3V$ to $\pm 18V$		0.9	1.3	mA
V_{OUT}	Output Voltage Swing	$R_L = 10k$ $V_S = \pm 2.3V$ to $\pm 5V$ $V_S = \pm 5V$ to $\pm 18V$ $V_S = \pm 2.3V$ to $\pm 5V$ $V_S = \pm 5V$ to $\pm 18V$	$-V_S + 1.1$ $-V_S + 1.2$ $-V_S + 1.4$ $-V_S + 1.6$		$+V_S - 1.2$ $+V_S - 1.3$ $+V_S - 1.3$ $+V_S - 1.5$	V V V V
I_{OUT}	Output Current		20	27		mA
BW	Bandwidth	$G = 1$ $G = 10$ $G = 100$ $G = 1000$		1000 800 120 12		kHz kHz kHz kHz
SR	Slew Rate	$G = 1$, $V_{OUT} = \pm 10V$		1.2		V/ μs
	Settling Time to 0.01%	10V Step $G = 1$ to 100 $G = 1000$		14 130		μs μs
R_{REFIN}	Reference Input Resistance			20		k Ω
I_{REFIN}	Reference Input Current	$V_{REF} = 0V$		50		μA
V_{REF}	Reference Voltage Range		$-V_S + 1.6$		$+V_S - 1.6$	V
A_{VREF}	Reference Gain to Output			1 ± 0.0001		

The ● denotes specifications that apply over the full specified temperature range.

Note 1: Absolute Maximum Ratings are those values beyond which the life of a device may be impaired.

Note 2: Does not include the effect of the external gain resistor R_G .

Note 3: This parameter is not 100% tested.

Note 4: The LT1920C is designed, characterized and expected to meet the industrial temperature limits, but is not tested at $-40^\circ C$ and $85^\circ C$. I-grade parts are guaranteed.

Note 5: This parameter is measured in a high speed automatic tester that does not measure the thermal effects with longer time constants. The magnitude of these thermal effects are dependent on the package used, heat sinking and air flow conditions.

Note 6: Typical parameters are defined as the 60% of the yield parameter distribution.

TYPICAL PERFORMANCE CHARACTERISTICS

Gain Nonlinearity, G = 1

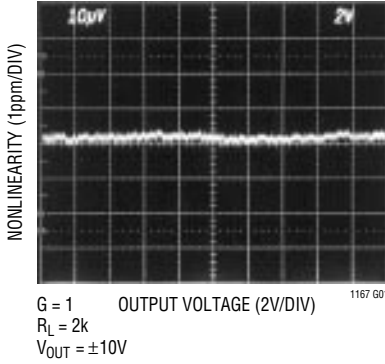

Gain Nonlinearity, G = 10

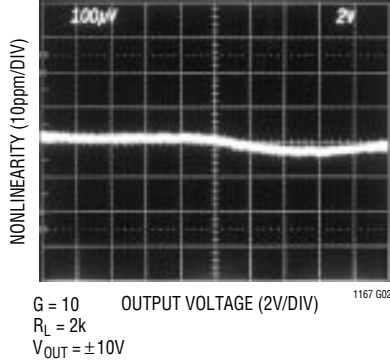

Gain Nonlinearity, G = 100

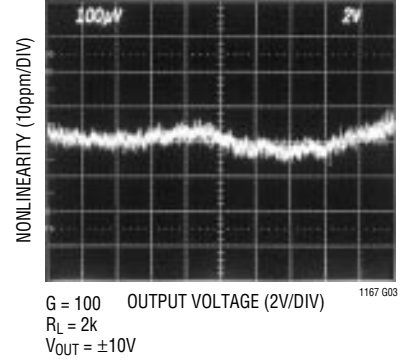

Gain Nonlinearity, G = 1000

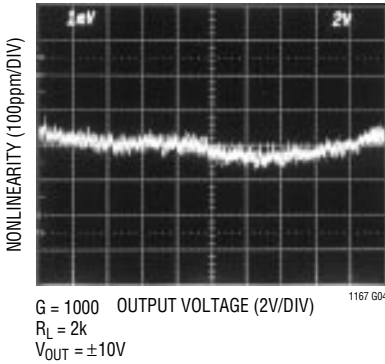

Gain Error vs Temperature

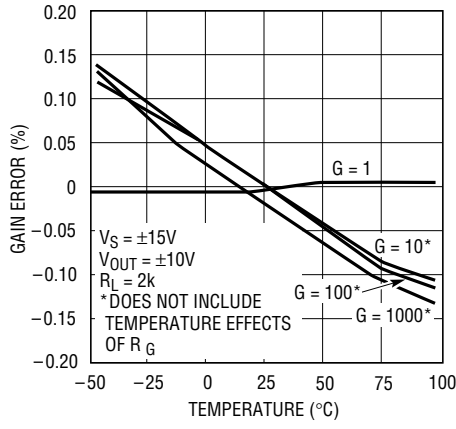

Warm-Up Drift

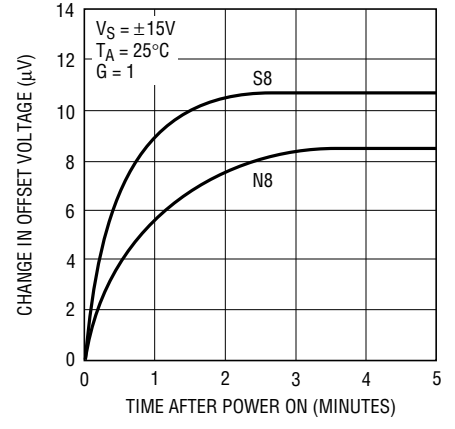

Input Bias Current vs Common Mode Input Voltage

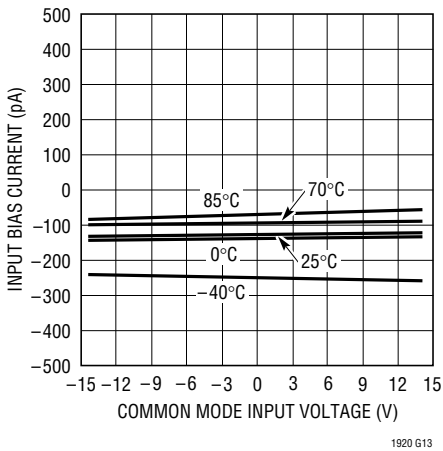

Common Mode Rejection Ratio vs Frequency

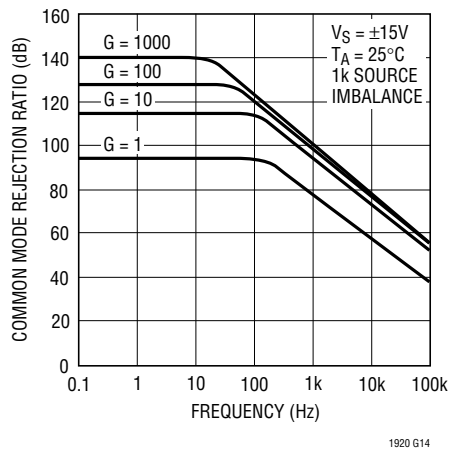

Negative Power Supply Rejection Ratio vs Frequency

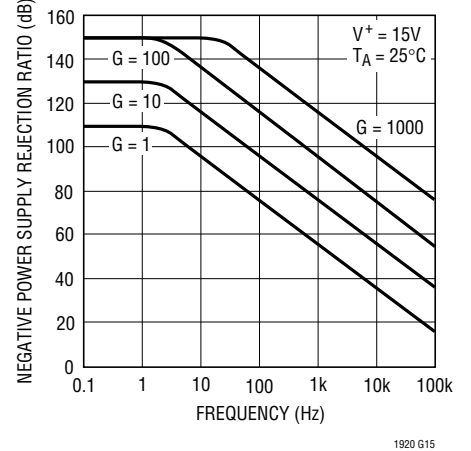

TYPICAL PERFORMANCE CHARACTERISTICS

Positive Power Supply Rejection Ratio vs Frequency

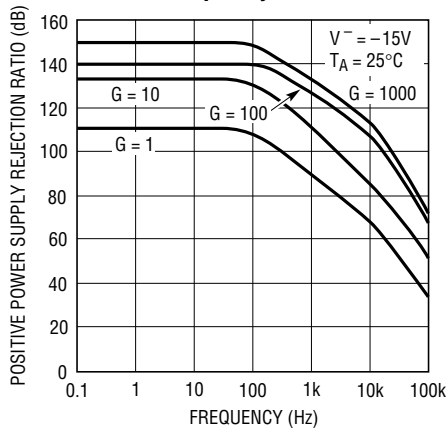

1920 G16

Gain vs Frequency

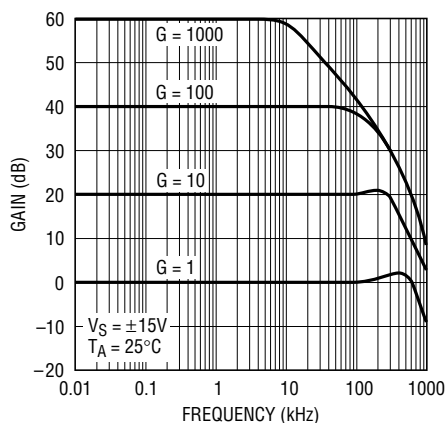

1920 G17

Supply Current vs Supply Voltage

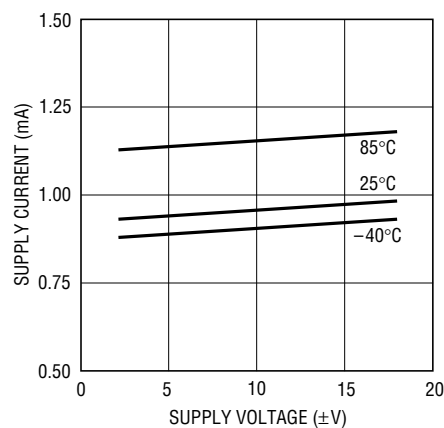

1920 G18

Voltage Noise Density vs Frequency

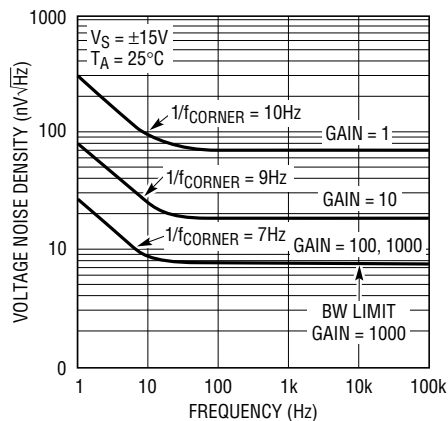

1920 G19

0.1Hz to 10Hz Noise Voltage, G = 1

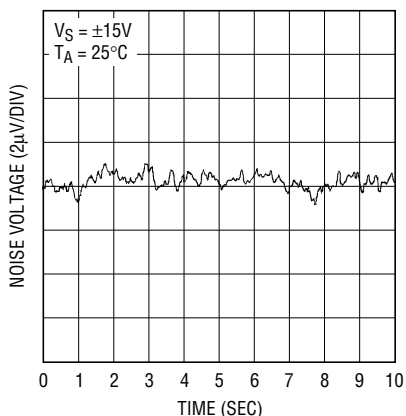

1920 G20

0.1Hz to 10Hz Noise Voltage, RTI G = 1000

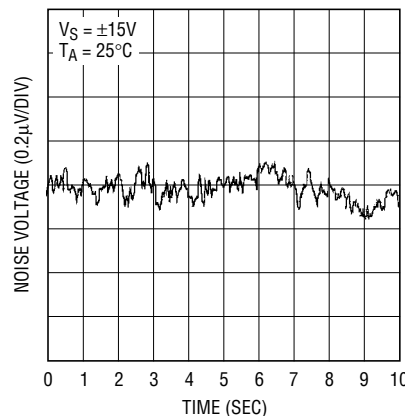

1920 G21

Current Noise Density vs Frequency

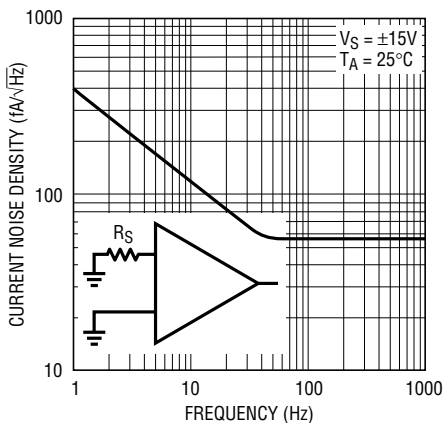

1920 G22

0.1Hz to 10Hz Current Noise

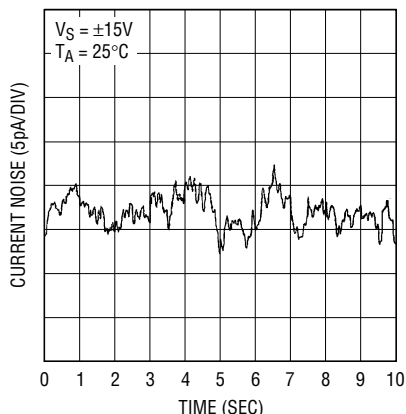

1920 G23

Short-Circuit Current vs Time

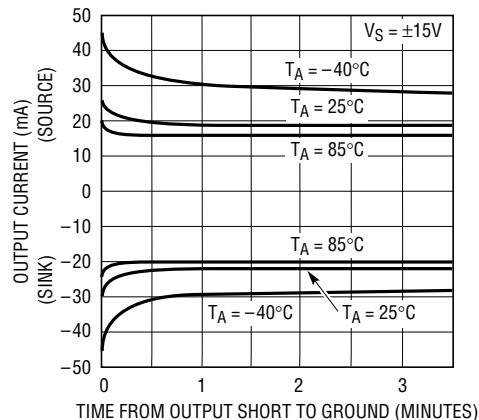

1920 G24

TYPICAL PERFORMANCE CHARACTERISTICS

Large-Signal Transient Response

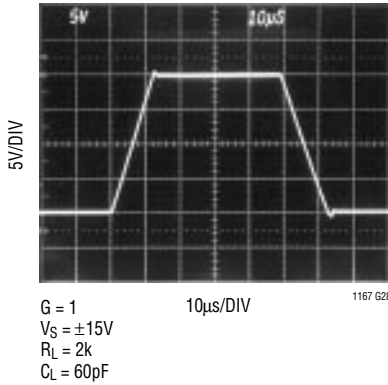

Small-Signal Transient Response

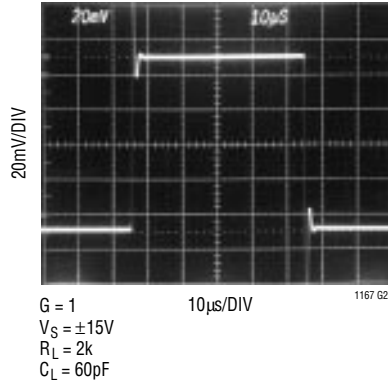

Overshoot vs Capacitive Load

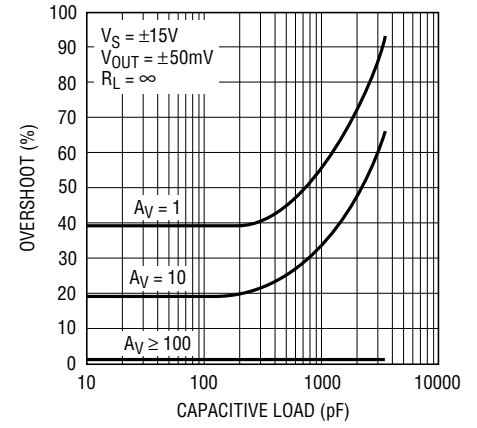

Large-Signal Transient Response

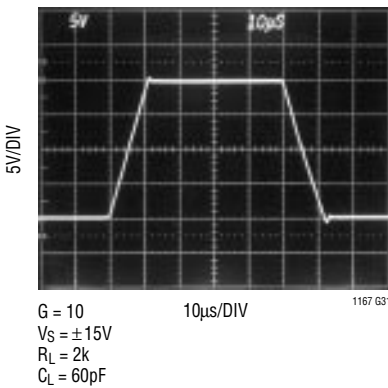

Small-Signal Transient Response

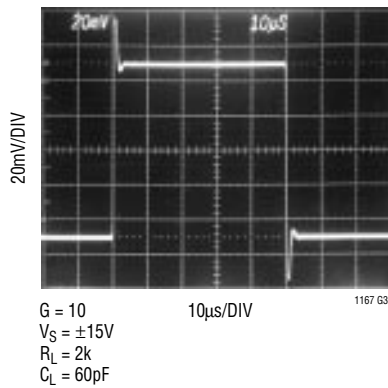

Output Impedance vs Frequency

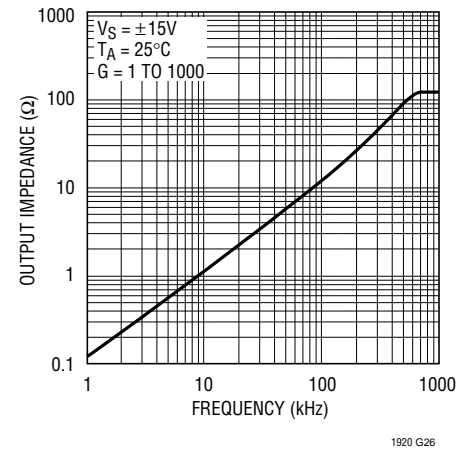

Large-Signal Transient Response

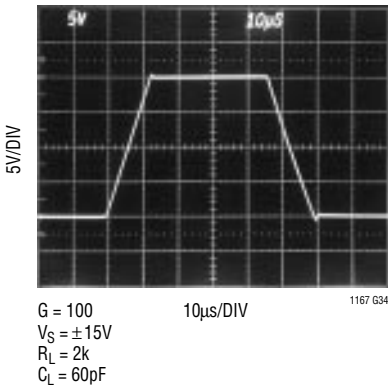

Small-Signal Transient Response

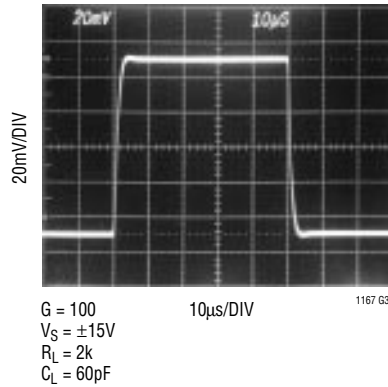

Undistorted Output Swing vs Frequency

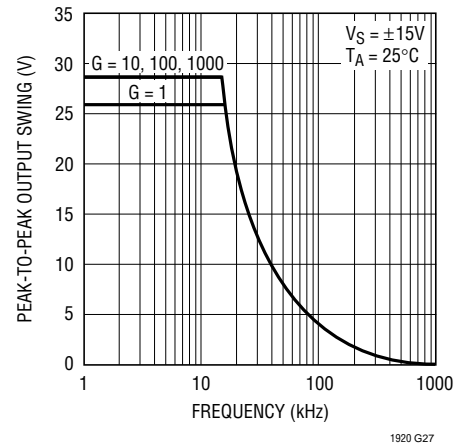

TYPICAL PERFORMANCE CHARACTERISTICS

Large-Signal Transient Response

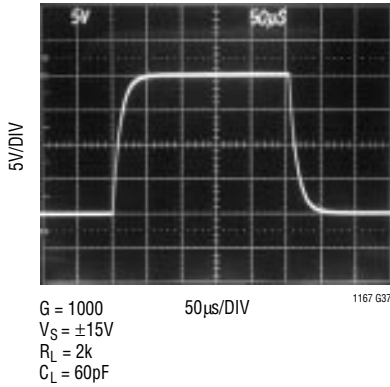

Small-Signal Transient Response

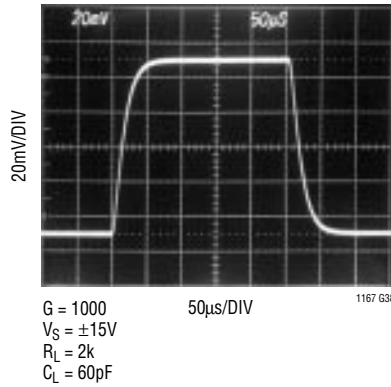

Settling Time vs Gain

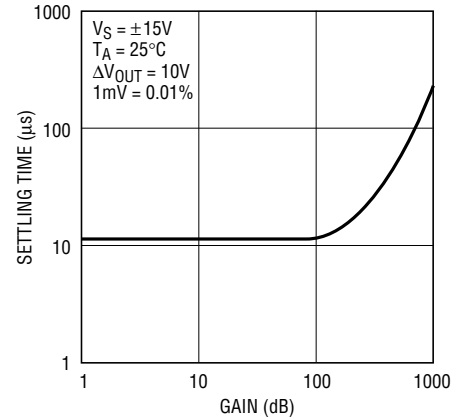

Settling Time vs Step Size

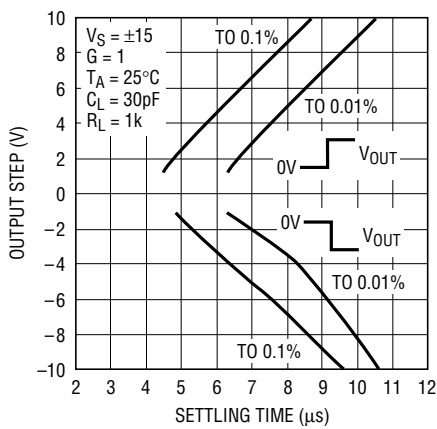

Slew Rate vs Temperature

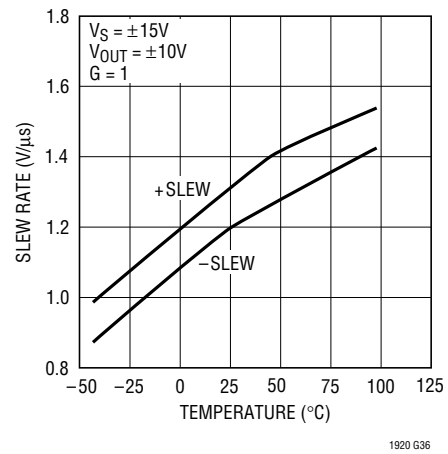

Output Voltage Swing vs Load Current

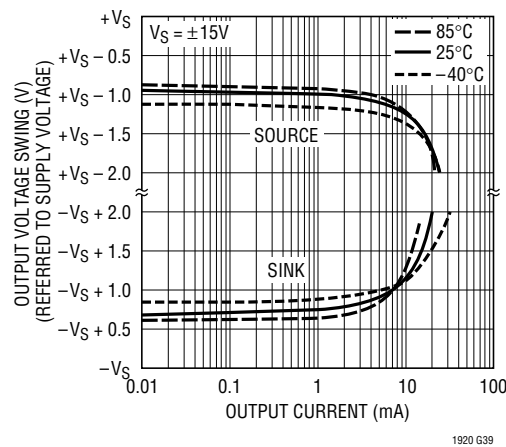

BLOCK DIAGRAM

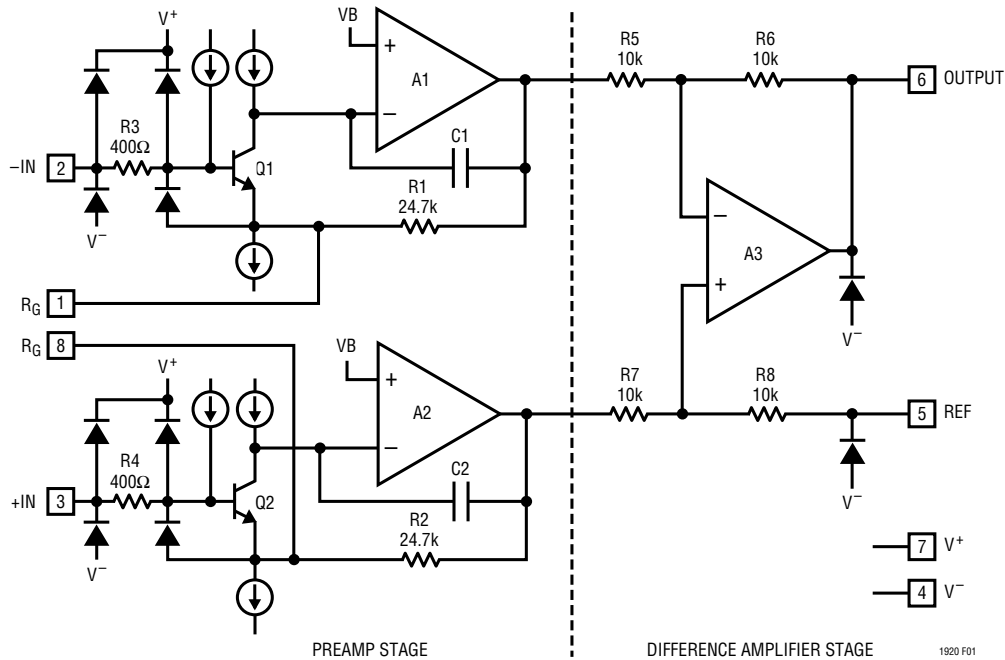

Figure 1. Block Diagram

THEORY OF OPERATION

The LT1920 is a modified version of the three op amp instrumentation amplifier. Laser trimming and monolithic construction allow tight matching and tracking of circuit parameters over the specified temperature range. Refer to the block diagram (Figure 1) to understand the following circuit description. The collector currents in Q1 and Q2 are trimmed to minimize offset voltage drift, thus assuring a high level of performance. R1 and R2 are trimmed to an absolute value of 24.7k to assure that the gain can be set accurately (0.3% at $G = 100$) with only one external resistor R_G . The value of R_G in parallel with R1 (R2) determines the transconductance of the preamp stage. As R_G is reduced for larger programmed gains, the transconductance of the input preamp stage increases to that of the input transistors Q1 and Q2. This increases the open-loop gain when the programmed gain is increased, reducing the input referred gain related errors and noise. The input voltage noise at gains greater than 50 is determined only by Q1 and Q2. At lower gains the noise of the difference amplifier and preamp gain setting resistors increase the noise. The gain bandwidth product is determined by C1, C2 and the preamp transconductance which increases

with programmed gain. Therefore, the bandwidth does not drop proportional to gain.

The input transistors Q1 and Q2 offer excellent matching, which is inherent in NPN bipolar transistors, as well as picoampere input bias current due to superbeta processing. The collector currents in Q1 and Q2 are held constant due to the feedback through the Q1-A1-R1 loop and Q2-A2-R2 loop which in turn impresses the differential input voltage across the external gain set resistor R_G . Since the current that flows through R_G also flows through R1 and R2, the ratios provide a gained-up differential voltage, $G = (R1 + R2)/R_G$, to the unity-gain difference amplifier A3. The common mode voltage is removed by A3, resulting in a single-ended output voltage referenced to the voltage on the REF pin. The resulting gain equation is:

$$V_{OUT} - V_{REF} = G(V_{IN}^+ - V_{IN}^-)$$

where:

$$G = (49.4k\Omega/R_G) + 1$$

solving for the gain set resistor gives:

$$R_G = 49.4k\Omega/(G - 1)$$

THEORY OF OPERATION

Input and Output Offset Voltage

The offset voltage of the LT1920 has two components: the output offset and the input offset. The total offset voltage referred to the input (RTI) is found by dividing the output offset by the programmed gain (G) and adding it to the input offset. At high gains the input offset voltage dominates, whereas at low gains the output offset voltage dominates. The total offset voltage is:

$$\begin{aligned} \text{Total input offset voltage (RTI)} \\ &= \text{input offset} + (\text{output offset}/G) \end{aligned}$$

$$\begin{aligned} \text{Total output offset voltage (RTO)} \\ &= (\text{input offset} \cdot G) + \text{output offset} \end{aligned}$$

Reference Terminal

The reference terminal is one end of one of the four 10k resistors around the difference amplifier. The output voltage of the LT1920 (Pin 6) is referenced to the voltage on the reference terminal (Pin 5). Resistance in series with the REF pin must be minimized for best common mode rejection. For example, a 2Ω resistance from the REF pin to ground will not only increase the gain error by 0.02% but will lower the CMRR to 80dB.

Single Supply Operation

For single supply operation, the REF pin can be at the same potential as the negative supply (Pin 4) provided the output of the instrumentation amplifier remains inside the specified operating range and that one of the inputs is at least 2.5V above ground. The barometer application on the front page of this data sheet is an example that satisfies these conditions. The resistance R_{SET} from the bridge transducer to ground sets the operating current for the bridge and also has the effect of raising the input common mode voltage. The output of the LT1920 is always inside the specified range since the barometric pressure rarely goes low enough to cause the output to rail (30.00 inches of Hg corresponds to 3.000V). For applications that require the output to swing at or below the REF potential, the voltage on the REF pin can be level shifted. An op amp is used to buffer the voltage on the REF pin since a parasitic series resistance will degrade the CMRR. The application in the back of this data sheet, Four Digit Pressure Sensor, is an example.

Output Offset Trimming

The LT1920 is laser trimmed for low offset voltage so that no external offset trimming is required for most applications. In the event that the offset needs to be adjusted, the circuit in Figure 2 is an example of an optional offset adjust circuit. The op amp buffer provides a low impedance to the REF pin where resistance must be kept to minimum for best CMRR and lowest gain error.

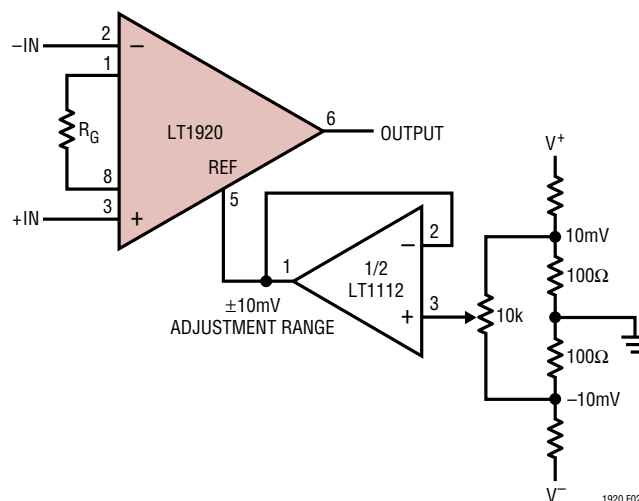

Figure 2. Optional Trimming of Output Offset Voltage

Input Bias Current Return Path

The low input bias current of the LT1920 (2nA) and the high input impedance (200GΩ) allow the use of high impedance sources without introducing additional offset voltage errors, even when the full common mode range is required. However, a path must be provided for the input bias currents of both inputs when a purely differential signal is being amplified. Without this path the inputs will float to either rail and exceed the input common mode range of the LT1920, resulting in a saturated input stage. Figure 3 shows three examples of an input bias current path. The first example is of a purely differential signal source with a 10kΩ input current path to ground. Since the impedance of the signal source is low, only one resistor is needed. Two matching resistors are needed for higher impedance signal sources as shown in the second example. Balancing the input impedance improves both common mode rejection and DC offset. The need for input resistors is eliminated if a center tap is present as shown in the third example.

THEORY OF OPERATION

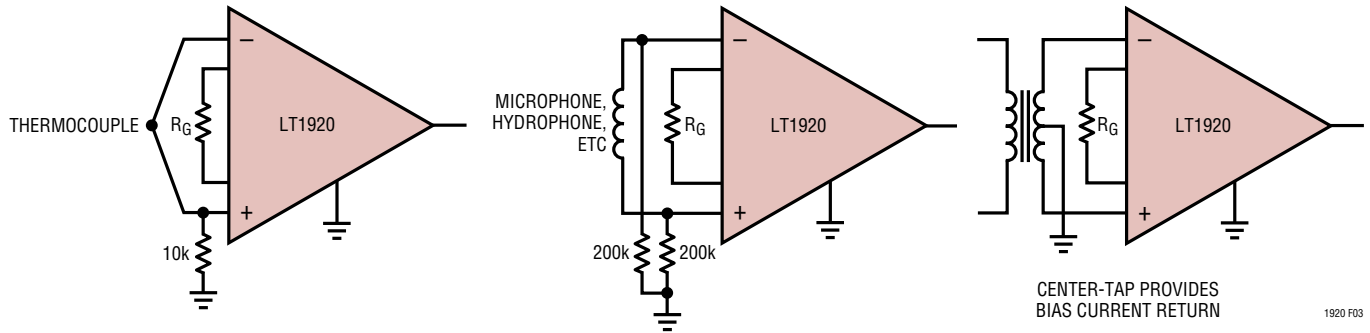

Figure 3. Providing an Input Common Mode Current Path

APPLICATIONS INFORMATION

The LT1920 is a low power precision instrumentation amplifier that requires only one external resistor to accurately set the gain anywhere from 1 to 1000. The output can handle capacitive loads up to 1000pF in any gain configuration and the inputs are protected against ESD strikes up to 13kV (human body).

Input Protection

The LT1920 can safely handle up to $\pm 20\text{mA}$ of input current in an overload condition. Adding an external 5k input resistor in series with each input allows DC input fault voltages up to $\pm 100\text{V}$ and improves the ESD immunity to 8kV (contact) and 15kV (air discharge), which is the IEC 1000-4-2 level 4 specification. If lower value input resistors are needed, a clamp diode from the positive supply to each input will maintain the IEC 1000-4-2 specification to level 4 for both air and contact discharge. A 2N4393 drain/source to gate is a good low leakage diode for use with 1k resistors, see Figure 4. The input resistors should be carbon and not metal film or carbon film.

RFI Reduction

In many industrial and data acquisition applications, instrumentation amplifiers are used to accurately amplify small signals in the presence of large common mode voltages or high levels of noise. Typically, the sources of these very small signals (on the order of microvolts or millivolts) are sensors that can be a significant distance from the signal conditioning circuit. Although these sen-

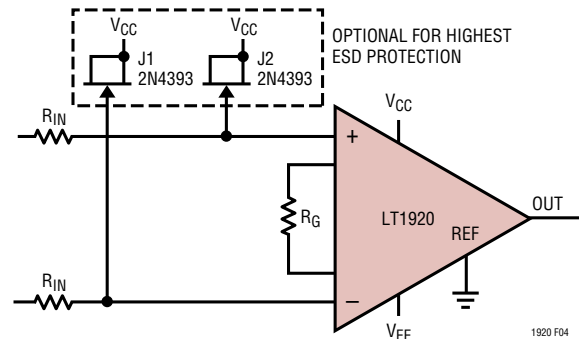

Figure 4. Input Protection

sors may be connected to signal conditioning circuitry, using shielded or unshielded twisted-pair cabling, the cabling may act as antennae, conveying very high frequency interference directly into the input stage of the LT1920.

The amplitude and frequency of the interference can have an adverse effect on an instrumentation amplifier's input stage by causing an unwanted DC shift in the amplifier's input offset voltage. This well known effect is called RFI rectification and is produced when out-of-band interference is coupled (inductively, capacitively or via radiation) and rectified by the instrumentation amplifier's input transistors. These transistors act as high frequency signal detectors, in the same way diodes were used as RF envelope detectors in early radio designs. Regardless of the type of interference or the method by which it is coupled into the circuit, an out-of-band error signal appears in series with the instrumentation amplifier's inputs.

APPLICATIONS INFORMATION

To significantly reduce the effect of these out-of-band signals on the input offset voltage of instrumentation amplifiers, simple lowpass filters can be used at the inputs. This filter should be located very close to the input pins of the circuit. An effective filter configuration is illustrated in Figure 5, where three capacitors have been added to the inputs of the LT1920. Capacitors C_{XCM1} and C_{XCM2} form lowpass filters with the external series resistors $R_{S1,2}$ to any out-of-band signal appearing on each of the input traces. Capacitor C_{XD} forms a filter to reduce any unwanted signal that would appear across the input traces. An added benefit to using C_{XD} is that the circuit's AC common mode rejection is not degraded due to common mode capacitive imbalance. The differential mode and common mode time constants associated with the capacitors are:

$$t_{DM(LPF)} = (2)(R_S)(C_{XD})$$

$$t_{CM(LPF)} = (R_{S1,2})(C_{XCM1,2})$$

Setting the time constants requires a knowledge of the frequency, or frequencies of the interference. Once this frequency is known, the common mode time constants can be set followed by the differential mode time constant. Set the common mode time constants such that they do not degrade the LT1920's inherent AC CMR. Then the differential mode time constant can be set for the bandwidth required for the application. Setting the differential

mode time constant close to the sensor's BW also minimizes any noise pickup along the leads. To avoid any possibility of inadvertently affecting the signal to be processed, set the common mode time constant an order of magnitude (or more) larger than the differential mode time constant. To avoid any possibility of common mode to differential mode signal conversion, match the common mode time constants to 1% or better. If the sensor is an RTD or a resistive strain gauge, then the series resistors $R_{S1,2}$ can be omitted, if the sensor is in proximity to the instrumentation amplifier.

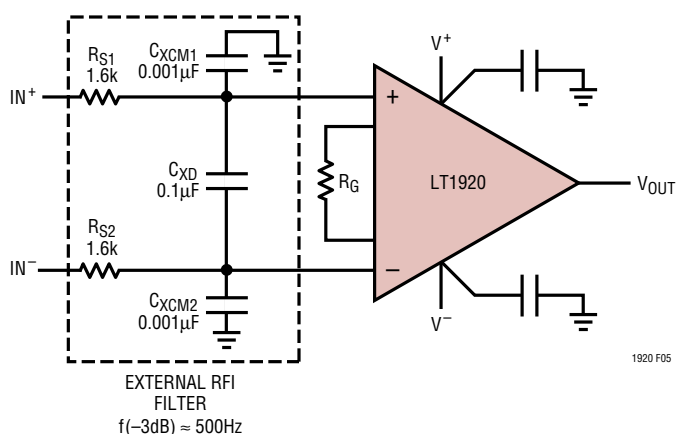
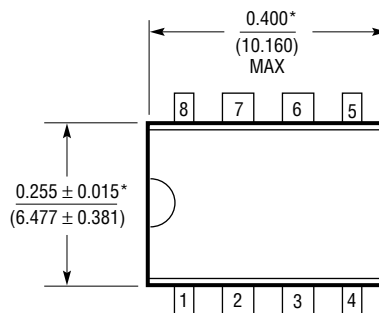
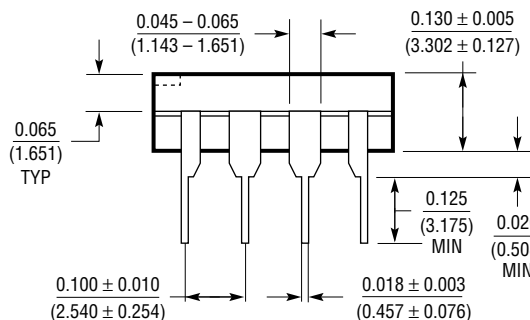
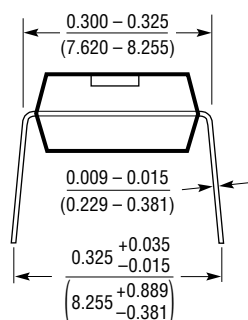

Figure 5. Adding a Simple RC Filter at the Inputs to an Instrumentation Amplifier is Effective in Reducing Rectification of High Frequency Out-of-Band Signals

PACKAGE DESCRIPTION

Dimensions in inches (millimeters) unless otherwise noted.

N8 Package 8-Lead PDIP (Narrow 0.300) (LTC DWG # 05-08-1510)



*THESE DIMENSIONS DO NOT INCLUDE MOLD FLASH OR PROTRUSIONS.
MOLD FLASH OR PROTRUSIONS SHALL NOT EXCEED 0.010 INCH (0.254mm)

TYPICAL APPLICATION

Nerve Impulse Amplifier

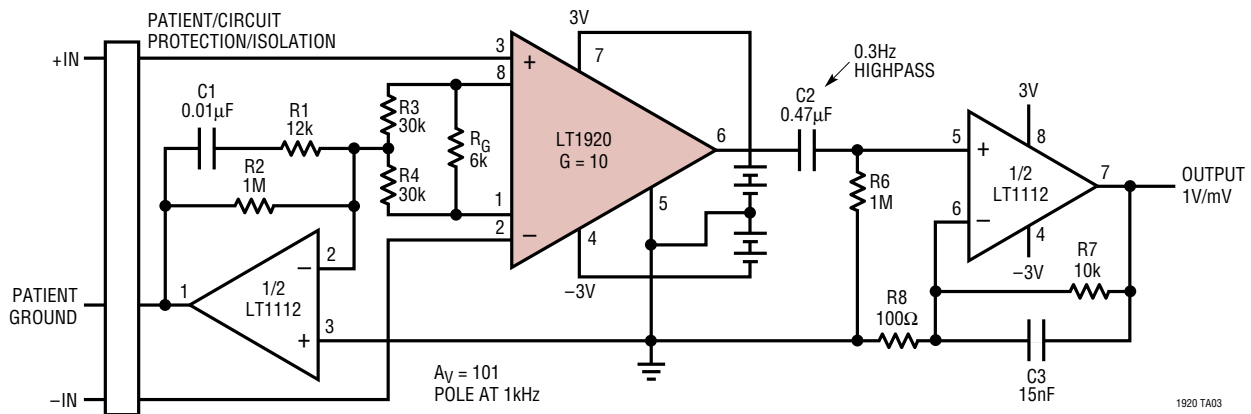

PACKAGE DESCRIPTION

Dimensions in inches (millimeters) unless otherwise noted.

S8 Package
8-Lead Plastic Small Outline (Narrow 0.150)
 (LTC DWG # 05-08-1610)

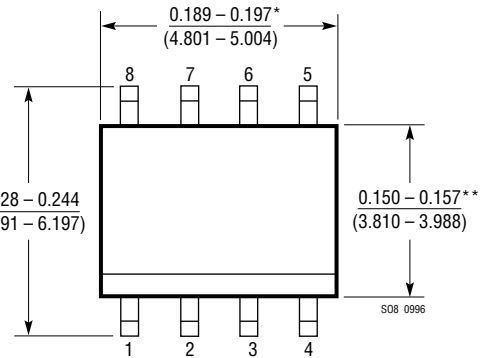
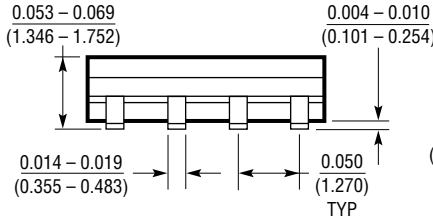
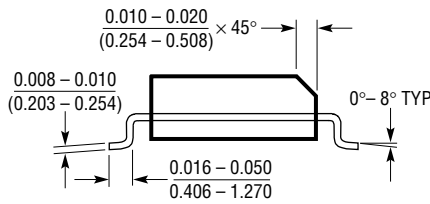

* DIMENSION DOES NOT INCLUDE MOLD FLASH. MOLD FLASH SHALL NOT EXCEED 0.006" (0.152mm) PER SIDE

** DIMENSION DOES NOT INCLUDE INTERLEAD FLASH. INTERLEAD FLASH SHALL NOT EXCEED 0.010" (0.254mm) PER SIDE

RELATED PARTS

PART NUMBER	DESCRIPTION	COMMENTS
LTC1100	Precision Chopper-Stabilized Instrumentation Amplifier	Best DC Accuracy
LT1101	Precision, Micropower, Single Supply Instrumentation Amplifier	Fixed Gain of 10 or 100, $I_S < 105\mu A$
LT1102	High Speed, JFET Instrumentation Amplifier	Fixed Gain of 10 or 100, 30V/ μs Slew Rate
LT1167	Single Resistor Gain Programmable Precision Instrumentation Amplifier	Upgraded Version of the LT1920
LTC®1418	14-Bit, Low Power, 200ksps ADC with Serial and Parallel I/O	Single Supply 5V or $\pm 5V$ Operation, $\pm 1.5LSB$ INL and $\pm 1LSB$ DNL Max
LT1460	Precision Series Reference	Micropower; 2.5V, 5V, 10V Versions; High Precision
LTC1562	Active RC Filter	Lowpass, Bandpass, Highpass Responses; Low Noise, Low Distortion, Four 2nd Order Filter Sections
LTC1605	16-Bit, 100ksps, Sampling ADC	Single 5V Supply, Bipolar Input Range: $\pm 10V$, Power Dissipation: 55mW Typ