

# Spezifikation für Freigabe / specification for release

Kunde / customer :  
 Artikelnummer / part number : **7443556350**  
 Bezeichnung : **SPEICHERDROSSEL WE-HCI**  
 description : **POWER-CHOKE WE-HCI**



DATUM / DATE : 2009-11-02

## A Mechanische Abmessungen / dimensions:

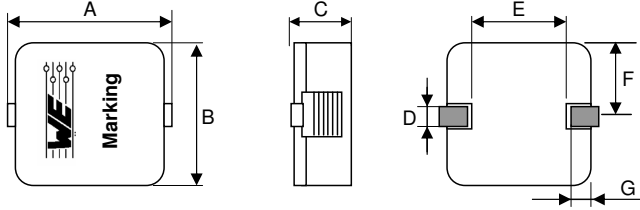

A	<b>18,3 ± 1,0</b>	mm
B	<b>18,2 ± 0,5</b>	mm
C	<b>8,9 ± 0,3</b>	mm
D	<b>4,2 ± 0,5</b>	mm
E	<b>8,0 ± 1,0</b>	mm
F	<b>9,0 ± 1,0</b>	mm
G	<b>5,0 ± 1,0</b>	mm

Marking = part number

## B Elektrische Eigenschaften / electrical properties:

Eigenschaften / properties	Testbedingungen / test conditions		Wert / value	Einheit / unit	tol.
Leerlaufinduktivität / initial inductance	<b>100 kHz / 10mA</b>	$L_0$	<b>3,50</b>	$\mu\text{H}$	$\pm 20\%$
DC-Widerstand / DC-resistance	<b>@ 20 °C</b>	$R_{DC}$	<b>3,10</b>	$\text{m}\Omega$	$\pm 8\%$
Nennstrom / rated current	<b><math>\Delta T = 50 \text{ K}</math></b>	$I_N$	<b>22,5</b>	A	typ.
Sättigungsstrom / saturation current	<b><math>\Delta L/L_0 = 30 \%</math></b>	$I_{sat}$	<b>37,0</b>	A	typ.
Eigenres.-Frequenz / self-res.-frequency		SRF	<b>38</b>	MHz	typ.

## C Lötpad / soldering spec.:

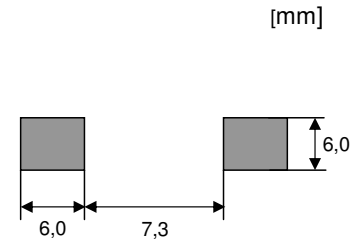

## D Prüfgeräte / test equipment:

**WAYNE KERR 3260B** für/for  $L_0$ ;  $R_{DC}$ ;  $I_{SAT}$ ;  $I_N$

## E Testbedingungen / test conditions:

Luftfeuchtigkeit / humidity: 33%  
 Umgebungstemperatur / temperature: +20 °C

## F Werkstoffe & Zulassungen / material & approvals:

Basismaterial / base material: WE-Perm2  
 Draht / wire: Polyamide/Imid coating

## G Eigenschaften / general specifications:

Arbeitstemperatur / operating temperature: -40 °C - +125 °C  
 Umgebungstemp. / ambient temperature: -40 °C - +75 °C  
 It is recommended that the temperature of the part does not exceed 125 °C under worst case operating conditions.  
 When exposed to shock and vibration stress, it is recommended to fix the device by separate means (such as glue, fasteners, etc).

Freigabe erteilt / general release:	Kunde / customer			
	Datum / date	Unterschrift / signature		
Geprüft / checked	Würth Elektronik	ME	Version 3	09-11-07
		Rst	Version 2	08-02-28
		Rst	Version 1	08-02-18
	Kontrolliert / approved	Name	Änderung / modification	Datum / date

### Würth Elektronik eiSos GmbH & Co. KG

D-74638 Waldenburg · Max-Eyth-Strasse 1 - 3 · Germany · Telefon (+49) (0) 7942 - 945 - 0 · Telefax (+49) (0) 7942 - 945 - 400  
<http://www.we-online.de>

# Spezifikation für Freigabe / specification for release

Kunde / customer :  
 Artikelnummer / part number : **7443556350**  
 Bezeichnung : **SPEICHERDROSSEL WE-HCI**  
 description : **POWER-CHOKE WE-HCI**



DATUM / DATE : 2009-11-02

## H Induktivitätskurve / Inductance curve:

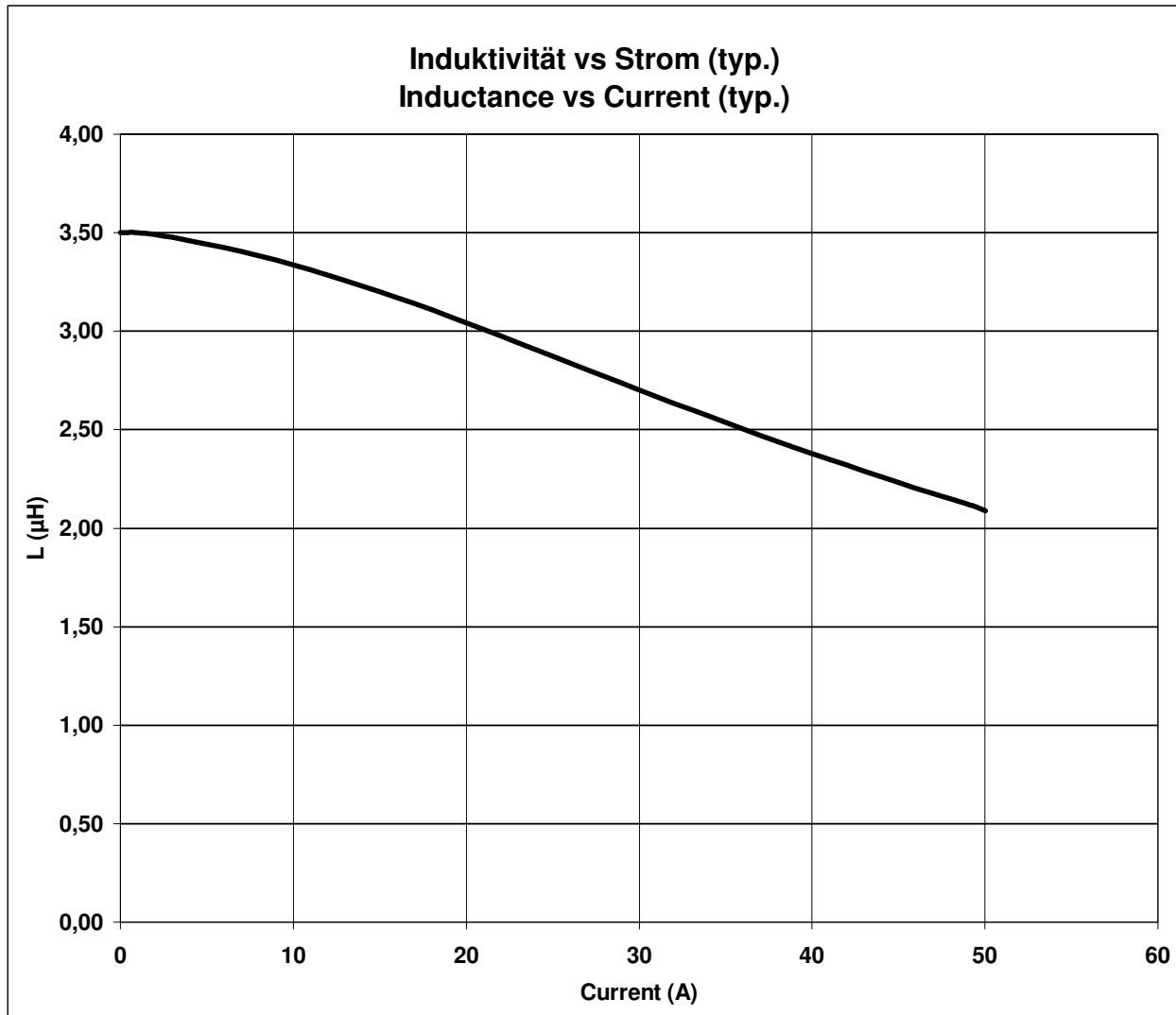

Freigabe erteilt / general release:	<b>Kunde / customer</b>			
.....	.....			
Datum / date	Unterschrift / signature			
	<b>Würth Elektronik</b>	ME	Version 3	09-11-07
		Rst	Version 2	08-02-28
		Rst	Version 1	08-02-18
Geprüft / checked	Kontrolliert / approved	Name	Änderung / modification	Datum / date

### Würth Elektronik eiSos GmbH & Co. KG

D-74638 Waldenburg · Max-Eyth-Strasse 1 - 3 · Germany · Telefon (+49) (0) 7942 - 945 - 0 · Telefax (+49) (0) 7942 - 945 - 400  
<http://www.we-online.de>

# Spezifikation für Freigabe / specification for release

Kunde / customer :  
 Artikelnummer / part number : **7443556350**  
 Bezeichnung : **SPEICHERDROSSEL WE-HCI**  
 description : **POWER-CHOKE WE-HCI**



DATUM / DATE : 2009-11-02

## I Temperaturanstieg / Temperature rise curve:

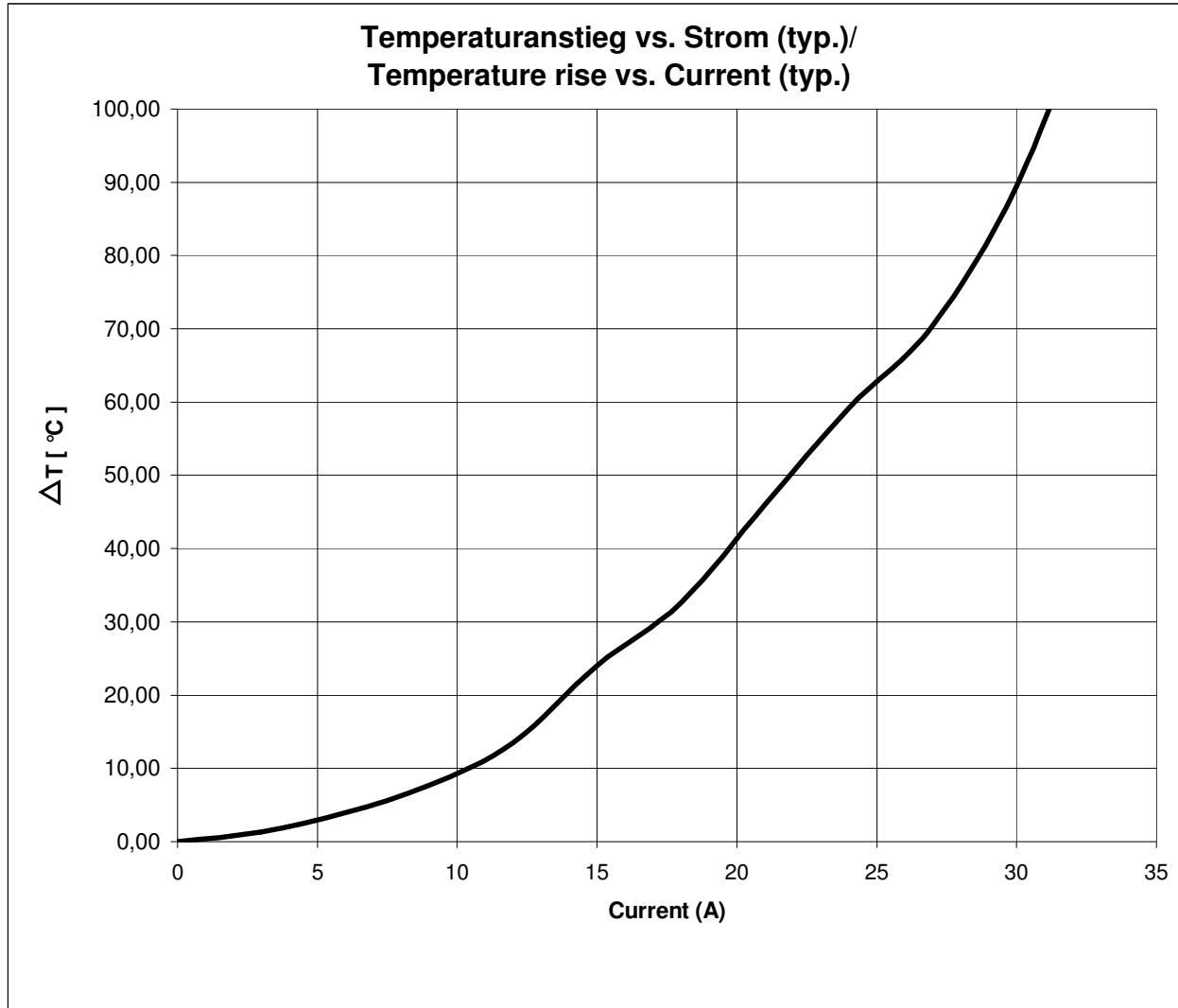

Freigabe erteilt / general release:	<b>Kunde / customer</b>			
Datum / date	Unterschrift / signature			
	<b>Würth Elektronik</b>	ME	Version 3	09-11-07
		Rst	Version 2	08-02-28
		Rst	Version 1	08-02-18
Geprüft / checked	Kontrolliert / approved	Name	Änderung / modification	Datum / date

### Würth Elektronik eiSos GmbH & Co. KG

D-74638 Waldenburg · Max-Eyth-Strasse 1 - 3 · Germany · Telefon (+49) (0) 7942 - 945 - 0 · Telefax (+49) (0) 7942 - 945 - 400  
<http://www.we-online.de>

# Spezifikation für Freigabe / specification for release

Kunde / customer :  
 Artikelnummer / part number : **7443556350**  
 Bezeichnung : **SPEICHERDROSSEL WE-HCI**  
 description : **POWER-CHOKE WE-HCI**



DATUM / DATE : 2009-11-02

## I Rollenspezifikation / tape and reel specification:

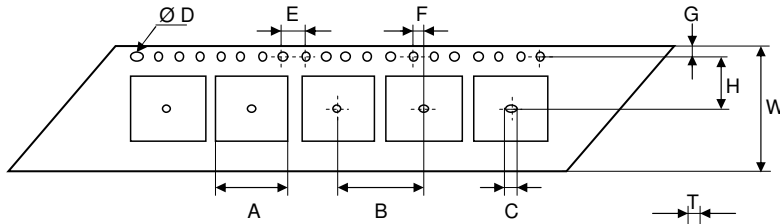

Gurtspezifikation / Tape specification:		
A	<b>19,3 ± 0,15</b>	mm
B	<b>32,0 ± 0,1</b>	mm
C	<b>2,00 typ</b>	mm
D	<b>1,50 min</b>	mm
E	<b>4,00 ± 0,1</b>	mm
F	<b>2,00 ± 0,1</b>	mm
G	<b>1,75 ± 0,1</b>	mm
H	<b>14,2 ± 0,1</b>	mm
I	<b>18,65 ± 0,15</b>	mm
J	<b>10,50 ± 0,15</b>	mm
T	<b>0,40 ± 0,05</b>	mm
W	<b>32,0 ± 0,3</b>	mm

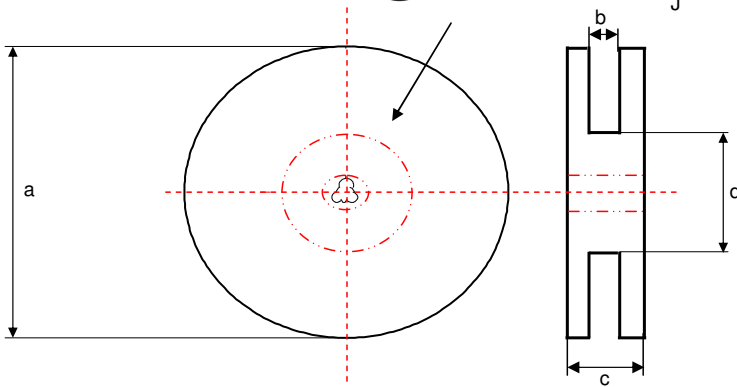

Rollenspezifikation / Reel specification:		
a	<b>330,0 ± 2,0</b>	mm
b	<b>32,5 ± 0,8</b>	mm
c	<b>37,5 ± 0,5</b>	mm
d	<b>100,0 ± 1,5</b>	mm

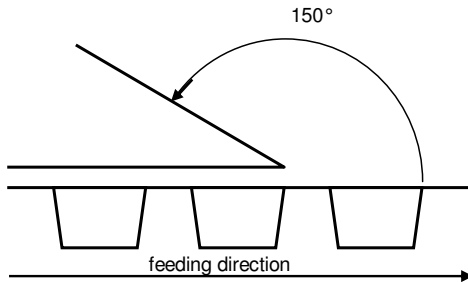

The Force for tearing off cover tape is 20 to 70 grams in arrow direction

Freigabe erteilt / general release:	Kunde / customer		
	Unterschrift / signature		
Datum / date	Würth Elektronik		
Geprüft / checked	Kontrolliert / approved		
	Name	Änderung / modification	Datum / date
	ME	Version 3	09-11-07
	Rst	Version 2	
	Rst	Version 1	08-02-18

This electronic component has been designed and developed for usage in general electronic equipment. Before incorporating this component into any equipment where higher safety and reliability is especially required or if there is the possibility of direct damage or injury to human body, for example in the range of aerospace, aviation, nuclear control, submarine, transportation, (automotive control, train control, ship control), transportation signal, disaster prevention, medical, public information network etc, Würth Elektronik eiSos GmbH must be informed before the design-in stage. In addition, sufficient reliability evaluation checks for safety must be performed on every electronic component which is used in electrical circuits that require high safety and reliability functions or performance.

## Würth Elektronik eiSos GmbH & Co. KG

D-74638 Waldenburg · Max-Eyth-Strasse 1 - 3 · Germany · Telefon (+49) (0) 7942 - 945 - 0 · Telefax (+49) (0) 7942 - 945 - 400  
<http://www.we-online.com>