

# Spezifikation für Freigabe / specification for release

Kunde / customer :  
 Artikelnummer / part number : **7443340100**  
 Bezeichnung : **SPEICHERDROSSEL WE-HCC 8070 (Ferrit)**  
 description : **POWER-CHOKE WE-HCC 8070 (Ferrite)**



DATUM / DATE : 2009-11-03

## A Mechanische Abmessungen / dimensions:

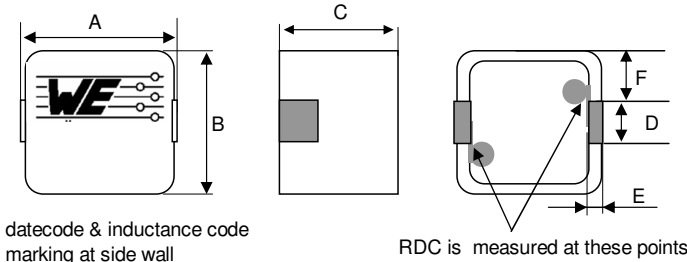

Dimension	Value	Unit
A	8,4 ± 0,4	mm
B	7,9 ± 0,3	mm
C	7,2 ± 0,3	mm
D	2,3 ± 0,2	mm
E	1,5 ± 0,2	mm
F	2,75 ± 0,5	mm

## B Elektrische Eigenschaften / electrical properties:

Eigenschaften / properties	Testbedingungen / test conditions		Wert / value	Einheit / unit	tol.
Lerrlaufinduktivität / initial inductance	100 kHz / 10mA	$L_0$	1,00	μH	± 20%
DC-Widerstand / DC-resistance	@ 20 °C	$R_{DC}$	2,95	mΩ	± 10%
Nennstrom / rated current	ΔT= 50 K	$I_N$	17,0	A	typ.
Sättigungsstrom / saturation current	ΔL/L <sub>0</sub> = 30 %	$I_{sat}$	24,0	A	typ.
Eigenres.-Frequenz / self-res.-frequency		SRF	147,0	MHz	typ.

## C Lötpad / soldering spec.:

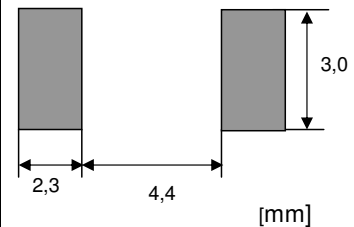

## D Prüfgeräte / test equipment:

WAYNE KERR 3260B für/for  $L_0$ ;  $I_{SAT}$   
 HP 34401 A & Fluke 54II für/for  $I_{DC}$ ;  
 Metra HIT 271 für/for  $R_{DC}$

## E Testbedingungen / test conditions:

Luftfeuchtigkeit / humidity: 33%  
 Umgebungstemperatur / temperature: +20 °C

## F Werkstoffe & Zulassungen / material & approvals:

Basismaterial / base material: Ferrite  
 Draht / wire: JIS 155 °C , UL : E201757

## G Eigenschaften / general specifications:

Arbeitstemperatur / operating temperature: -40 °C - +125 °C  
 Lagertemp. / storage temperature: -40 °C - +60 °C  
 It is recommended that the temperature of the part does not exceed 125 °C under worst case operating conditions.

Freigabe erteilt / general release:		Kunde / customer	
.....	.....	.....	.....
Datum / date	.....	Unterschrift / signature	.....
		Würth Elektronik	
.....	.....	BD	Version 2 09-11-03
.....	.....	Rst	Version 1 09-05-05
Geprüft / checked	.....	Name	Änderung / modification Datum / date

### Würth Elektronik eiSos GmbH & Co. KG

D-74638 Waldenburg · Max-Eyth-Strasse 1 - 3 · Germany · Telefon (+49) (0) 7942 - 945 - 0 · Telefax (+49) (0) 7942 - 945 - 400  
<http://www.we-online.de>

# Spezifikation für Freigabe / specification for release

Kunde / customer :

Artikelnummer / part number : **7443340100**

LF



Bezeichnung : **SPEICHERDROSSEL WE-HCC 8070 (Ferrit)**

description : **POWER-CHOKE WE-HCC 8070 (Ferrite)**

**WÜRTH ELEKTRONIK**

DATUM / DATE : 2009-11-03

## H Induktivitätskurve / Inductance curve:

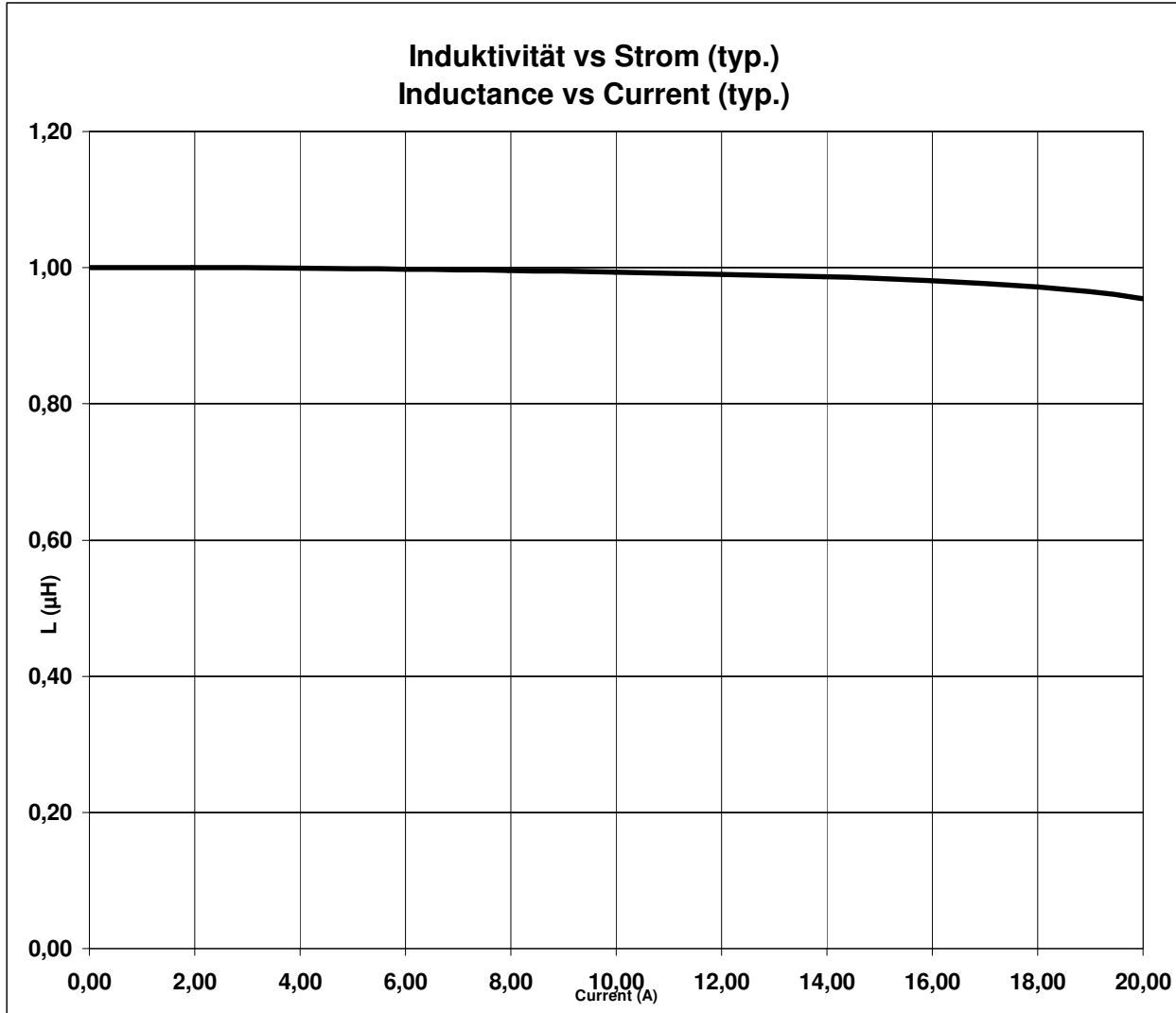

Freigabe erteilt / general release:	<b>Kunde / customer</b>			
.....	.....			
Datum / date	Unterschrift / signature			
	<b>Würth Elektronik</b>			
.....	.....	BD	Version 2	09-11-03
Geprüft / checked	Kontrolliert / approved	Rst	Version 1	09-05-05
		Name	<b>Änderung / modification</b>	Datum / date

### Würth Elektronik eiSos GmbH & Co. KG

D-74638 Waldenburg · Max-Eyth-Strasse 1 - 3 · Germany · Telefon (+49) (0) 7942 - 945 - 0 · Telefax (+49) (0) 7942 - 945 - 400  
http://www.we-online.de

# Spezifikation für Freigabe / specification for release

Kunde / customer :

Artikelnummer / part number : **7443340100**

LF



Bezeichnung : **SPEICHERDROSSEL WE-HCC 8070 (Ferrit)**

description : **POWER-CHOKE WE-HCC 8070 (Ferrite)**

DATUM / DATE : 2009-11-03

## I Temperaturanstieg / Temperature rise curve:

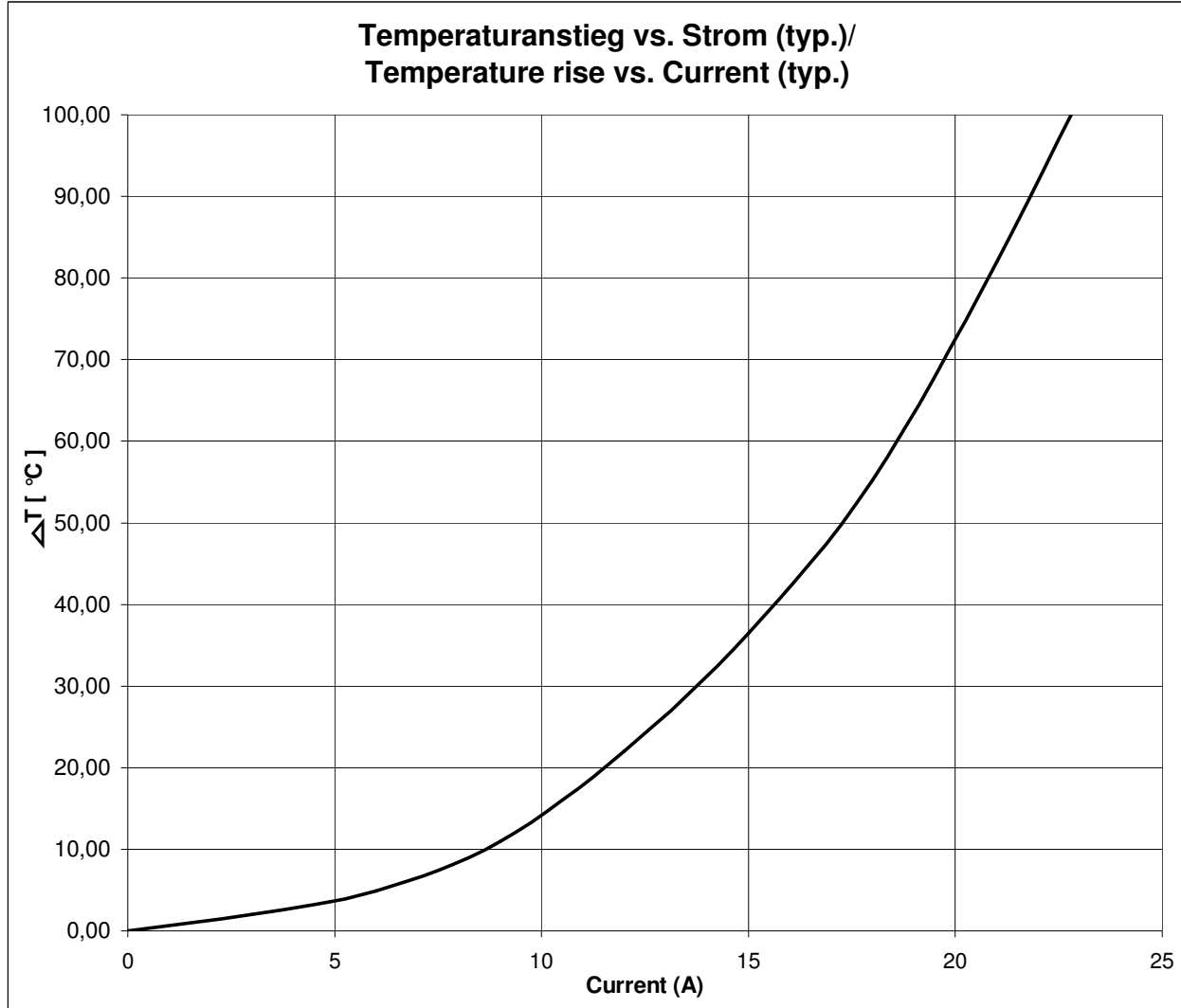

Freigabe erteilt / general release:	<b>Kunde / customer</b>			
.....	.....			
Datum / date	Unterschrift / signature			
.....	.....			
	<b>Würth Elektronik</b>			
.....	.....	BD	Version 2	09-11-03
.....	.....	Rst	Version 1	09-05-05
Geprüft / checked	Kontrolliert / approved	Name	Änderung / modification	Datum / date

**Würth Elektronik eiSos GmbH & Co. KG**

D-74638 Waldenburg · Max-Eyth-Strasse 1 - 3 · Germany · Telefon (+49) (0) 7942 - 945 - 0 · Telefax (+49) (0) 7942 - 945 - 400  
http://www.we-online.de

# Spezifikation für Freigabe / specification for release

Kunde / customer :  
 Artikelnummer / part number : **7443340100** LF  
 Bezeichnung : **SPEICHERDROSSEL WE-HCC 8070 (Ferrit)**  
 description : **POWER-CHOKE WE-HCC 8070 (Ferrite)**



DATUM / DATE : 2009-11-03

## J Rollenspezifikation / tape and reel specification:

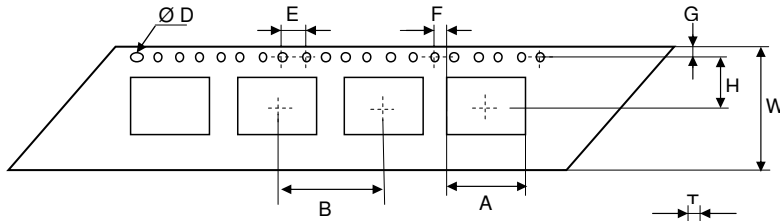

Gurtspezifikation / Tape specification:		
A	<b>8,25 ± 0,1</b>	mm
B	<b>16 ± 0,1</b>	mm
		mm
D	<b>1,50 ± 0,1</b>	mm
E	<b>4,00 ± 0,1</b>	mm
F	<b>2,00 ± 0,1</b>	mm
G	<b>1,75 ± 0,1</b>	mm
H	<b>11,5 ± 0,1</b>	mm
		mm
J	<b>7,40 ± 0,1</b>	mm
T	<b>0,40 ± 0,05</b>	mm
W	<b>24,0 ± 0,3</b>	mm

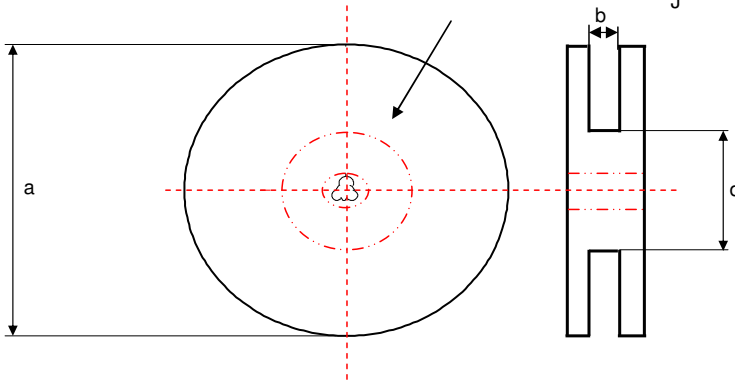

Rollenspezifikation / Reel specification:		
a	<b>330,0 ref</b>	mm
b	<b>24,0 ref</b>	mm
		mm
d	<b>75 ± 2</b>	mm

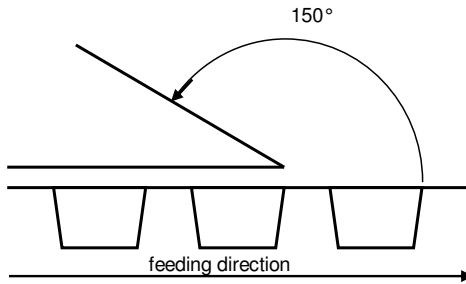

The Force for tearing off cover tape is 20 to 70 grams in arrow direction

Freigabe erteilt / general release:	Kunde / customer		
	Datum / date	Unterschrift / signature	
	Würth Elektronik		
	Geprüft / checked	Kontrolliert / approved	
		BD	Version 2 09-11-03
		Rst	Version 1 09-05-05
		Name	Änderung / modification Datum / date

This electronic component has been designed and developed for usage in general electronic equipment. Before incorporating this component into any equipment where higher safety and reliability is especially required or if there is the possibility of direct damage or injury to human body, for example in the range of aerospace, aviation, nuclear control, submarine, transportation, (automotive control, train control, ship control), transportation signal, disaster prevention, medical, public information network etc, Würth Elektronik eiSos GmbH must be informed before the design-in stage. In addition, sufficient reliability evaluation checks for safety must be performed on every electronic component which is used in electrical circuits that require high safety and reliability functions or performance.

### Würth Elektronik eiSos GmbH & Co. KG

D-74638 Waldenburg · Max-Eyth-Strasse 1 - 3 · Germany · Telefon (+49) (0) 7942 - 945 - 0 · Telefax (+49) (0) 7942 - 945 - 400  
<http://www.we-online.com>