



# PIC16C781/782

## PIC16C781/782 Rev. B3 Silicon/Data Sheet Errata

The PIC16C781/782 parts you have received conform functionally to the Device Data Sheet (DS41171A), except for the anomalies described below.

**Note:** The silicon revision of a specific component is identified by its manufacture date code: YYWW, YY is the year of manufacture and WW is the specific work week. All material with a date code of 0229 or later is revision B3 silicon, and subject to the Errata contained in this document. Any components with a earlier date code will be silicon revision B1 and will be covered in a separate Errata. For additional information concerning date codes, refer to the packaging information section of the PIC16C781/782 data sheet (DS41171A).

### 1. Module: Voltage Comparator

When the voltage comparator inputs are subjected to fast rise time pulses, some units exhibit a momentary invalid state on their output. The probability of generating an invalid output state is dependant upon four factors:

1. Pulse slew rate
2. Supply Voltage (VDD)
3. Ambient Temperature
4. Reference Voltage (VCOMMON\_MODE)

Figures 1 through 5 show the input slew rate limits for normal operation of the voltage comparators in Fast mode (CMxCON0<3>=1) for a variety of Common mode voltages, supply voltages and ambient temperatures.

If the PSMC is used in conjunction with the voltage comparators, an invalid voltage comparator output state can cause the premature termination of PSMC output pulses.

#### Work around

The pulse rise time of inputs to the voltage comparators should be less than the limits shown in Figures 1 through 5 for the specific conditions of operation (supply voltage, temperature, Common mode voltage). The values shown are for pulses with a constant rise time. For pulses with compound rise times (pulses with non-linear or changing slopes), the limits may be different.

**Note:** The area below the line for any given temperature is the safe operating area. Graph data is from B1 revision silicon. When B3 revision characterization data is available, the slew rate limits will be relaxed to reflect the improved performance of B3 silicon.

# PIC16C781/782

FIGURE 1: VOLTAGE COMPARATOR INPUT, MAXIMUM SLEW RATE AT  $V_{DD} = 5.5V$ , FAST MODE

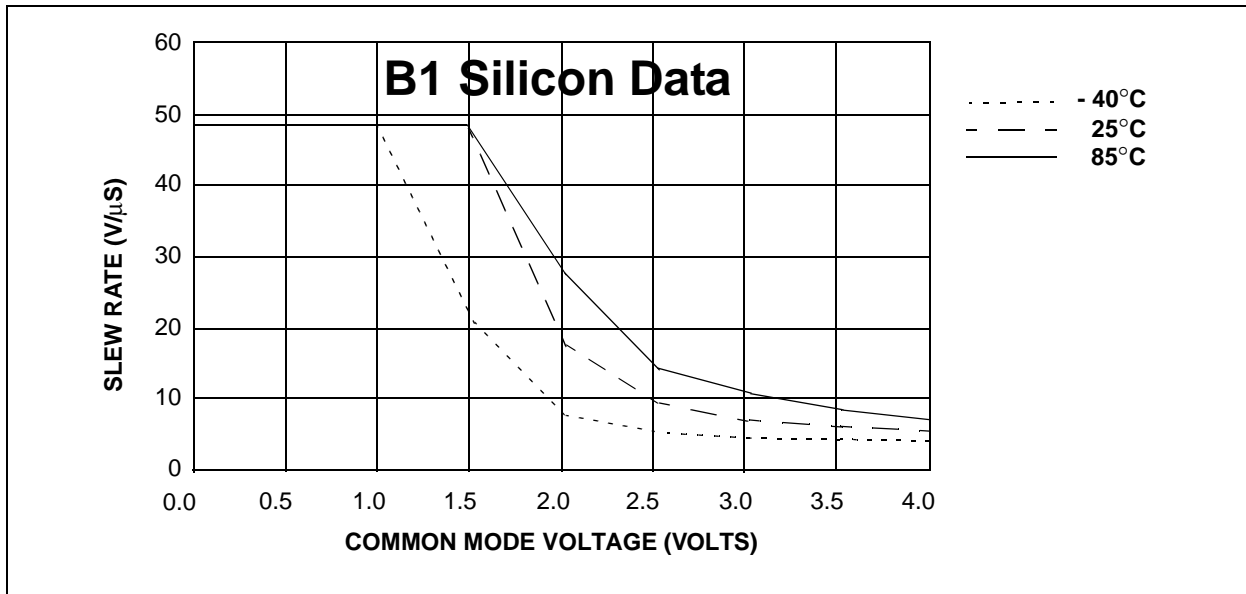
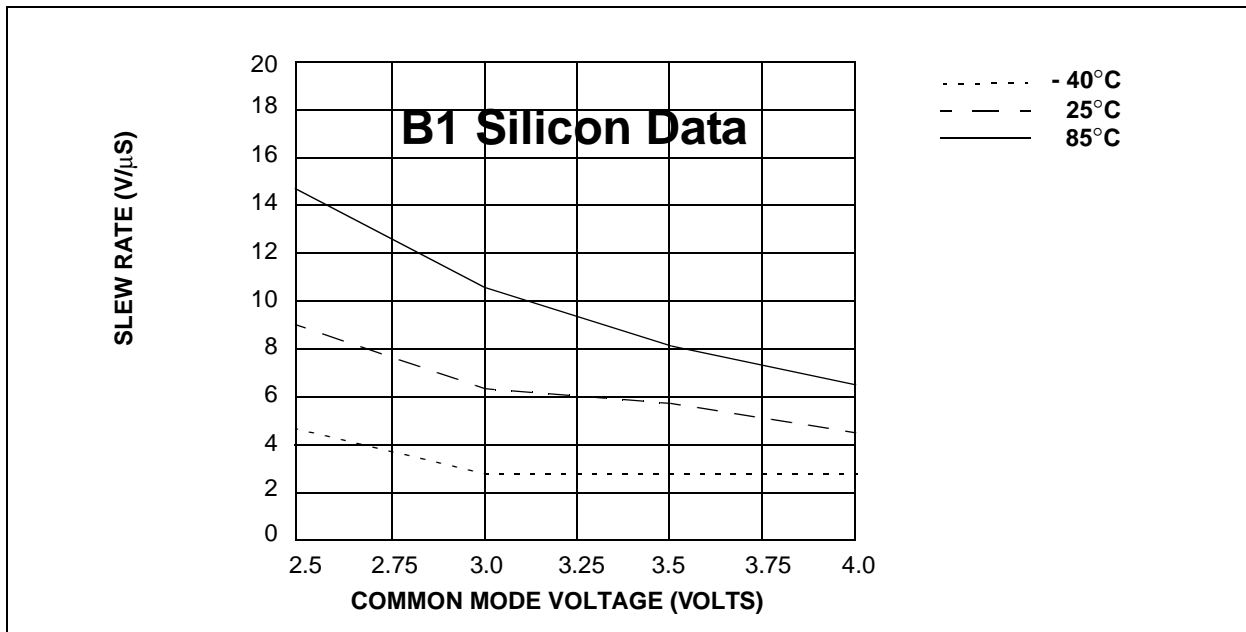
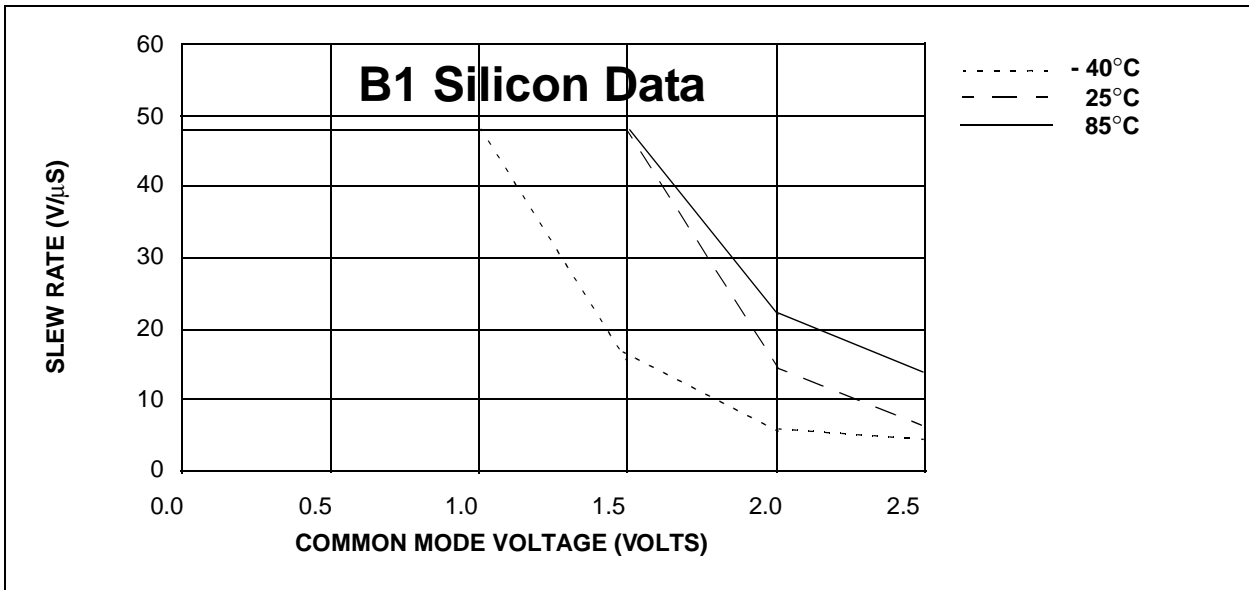


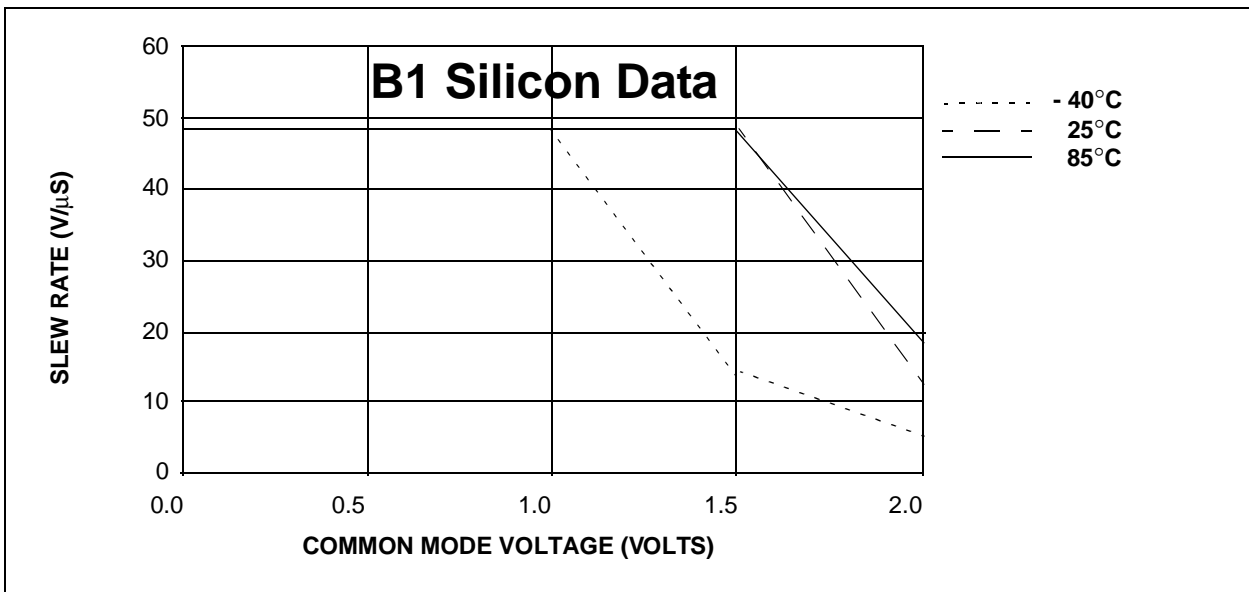
FIGURE 2: VOLTAGE COMPARATOR INPUT, MAXIMUM SLEW RATE AT  $V_{DD} = 5.5V$ , FAST MODE



**FIGURE 3: VOLTAGE COMPARATOR INPUT, MAXIMUM SLEW RATE AT  $V_{DD} = 4.0V$ , FAST MODE**

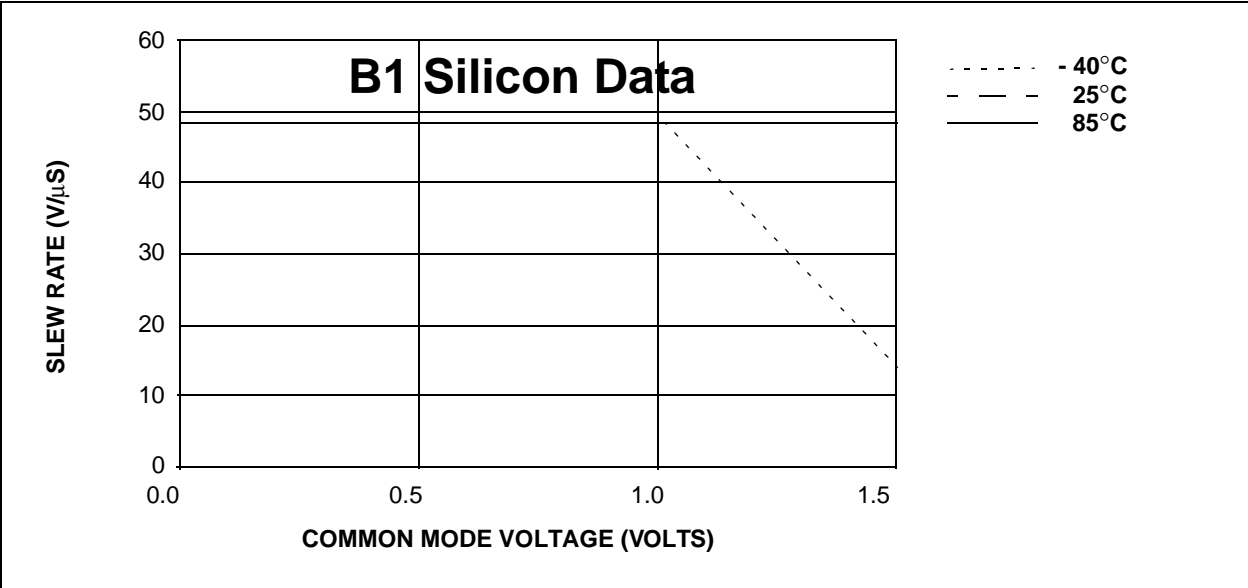


**FIGURE 4: VOLTAGE COMPARATOR INPUT, MAXIMUM SLEW RATE AT  $V_{DD} = 3.5V$ , FAST MODE**



# PIC16C781/782

FIGURE 5: VOLTAGE COMPARATOR INPUT, MAXIMUM SLEW RATE AT  $V_{DD} = 3.0V$ , FAST MODE



## Clarifications/Corrections to the Data Sheet:

In the Device Data Sheet (DS41171A), the following clarifications and corrections should be noted.

### 1. Module: I/O Ports

Exception to Figure 3-6 on page 32.

When the RA5 pin is configured as the external MCLR input (CONFIG<MCLRE> = 1), the port bit will read as set (RA<5> = 1), not cleared, as specified in Figure 3-6.

### 2. Module: Digital-to-Analog Converter

Correction to Example 10-1 on page 81.

The following line of code:

```
"BSF ANSEL,1 ;set RB1 as analog"
```

Should be:

```
"BSF ANSEL,5 ;set RB1 as analog"
```

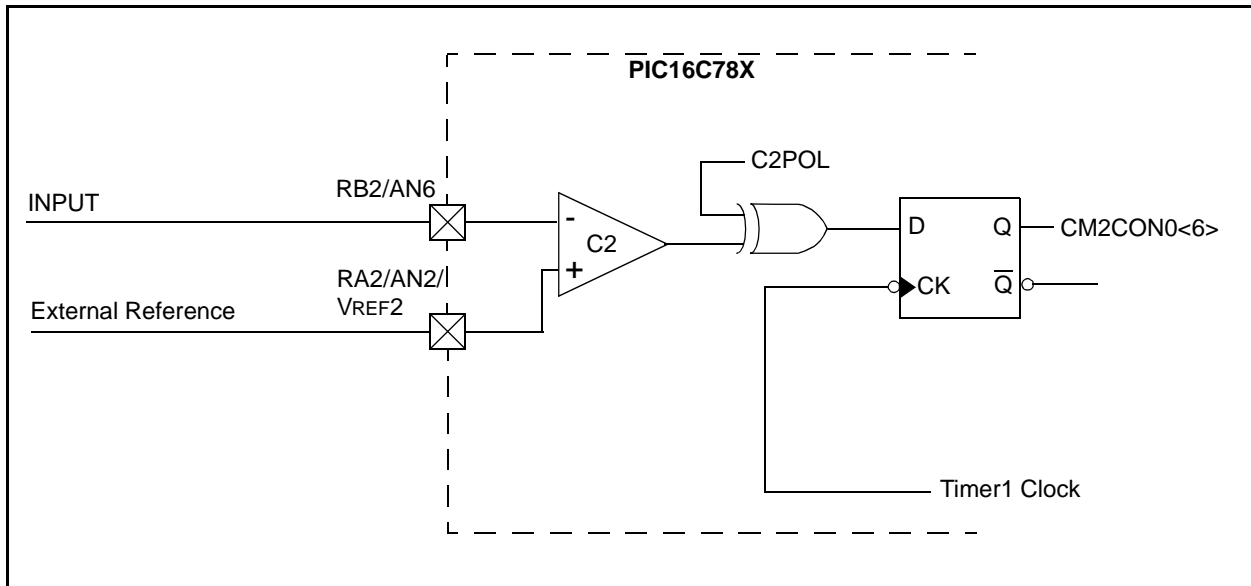
**Note:** DAC output function overrides ANSEL and TRISB register control of the port pin.

### 3. Module: Comparator Module

Correction to Figure 12-3 on page 95.

The synchronizing clock signal is supplied by the Timer1 clock, not the RA6 pin as shown in Figure 12-3.

**FIGURE 12-3: COMPARATOR C2 CONFIGURATION WITH OUTPUT SYNCHRONIZED TO TIMER1 CLOCK**



# PIC16C781/782

---

## REVISION HISTORY

Rev A Document (1/02)

Original errata document, which includes Item 1 and clarifications/corrections to Data Sheet, Items 1, 2 and 3.

---

---

**Note the following details of the code protection feature on PICmicro® MCUs.**

- The PICmicro family meets the specifications contained in the Microchip Data Sheet.
- Microchip believes that its family of PICmicro microcontrollers is one of the most secure products of its kind on the market today, when used in the intended manner and under normal conditions.
- There are dishonest and possibly illegal methods used to breach the code protection feature. All of these methods, to our knowledge, require using the PICmicro microcontroller in a manner outside the operating specifications contained in the data sheet. The person doing so may be engaged in theft of intellectual property.
- Microchip is willing to work with the customer who is concerned about the integrity of their code.
- Neither Microchip nor any other semiconductor manufacturer can guarantee the security of their code. Code protection does not mean that we are guaranteeing the product as “unbreakable”.
- Code protection is constantly evolving. We at Microchip are committed to continuously improving the code protection features of our product.

If you have any further questions about this matter, please contact the local sales office nearest to you.

---

Information contained in this publication regarding device applications and the like is intended through suggestion only and may be superseded by updates. It is your responsibility to ensure that your application meets with your specifications. No representation or warranty is given and no liability is assumed by Microchip Technology Incorporated with respect to the accuracy or use of such information, or infringement of patents or other intellectual property rights arising from such use or otherwise. Use of Microchip's products as critical components in life support systems is not authorized except with express written approval by Microchip. No licenses are conveyed, implicitly or otherwise, under any intellectual property rights.

#### **Trademarks**

The Microchip name and logo, the Microchip logo, KEELOQ, MPLAB, PIC, PICmicro, PICSTART and PRO MATE are registered trademarks of Microchip Technology Incorporated in the U.S.A. and other countries.


FilterLab, microID, MXDEV, MXLAB, PICMASTER, SEEVAL and The Embedded Control Solutions Company are registered trademarks of Microchip Technology Incorporated in the U.S.A.

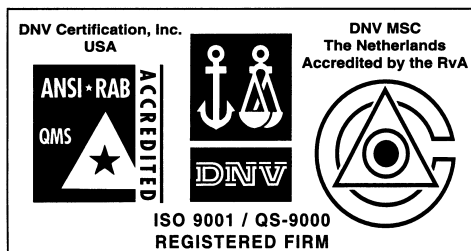
dsPIC, dsPICDEM.net, ECONOMONITOR, FanSense, FlexROM, fuzzyLAB, In-Circuit Serial Programming, ICSP, ICEPIC, microPort, Migratable Memory, MPASM, MPLIB, MPLINK, MPSIM, PICC, PICDEM, PICDEM.net, rPIC, Select Mode and Total Endurance are trademarks of Microchip Technology Incorporated in the U.S.A. and other countries.

Serialized Quick Turn Programming (SQTP) is a service mark of Microchip Technology Incorporated in the U.S.A.

All other trademarks mentioned herein are property of their respective companies.

© 2002, Microchip Technology Incorporated, Printed in the U.S.A., All Rights Reserved.

 Printed on recycled paper.



*Microchip received QS-9000 quality system certification for its worldwide headquarters, design and wafer fabrication facilities in Chandler and Tempe, Arizona in July 1999 and Mountain View, California in March 2002. The Company's quality system processes and procedures are QS-9000 compliant for its PICmicro® 8-bit MCUs, KEELOQ® code hopping devices, Serial EEPROMs, microperipherals, non-volatile memory and analog products. In addition, Microchip's quality system for the design and manufacture of development systems is ISO 9001 certified.*



# MICROCHIP

## WORLDWIDE SALES AND SERVICE

### AMERICAS

#### Corporate Office

2355 West Chandler Blvd.  
Chandler, AZ 85224-6199  
Tel: 480-792-7200 Fax: 480-792-7277  
Technical Support: 480-792-7627  
Web Address: <http://www.microchip.com>

#### Rocky Mountain

2355 West Chandler Blvd.  
Chandler, AZ 85224-6199  
Tel: 480-792-7966 Fax: 480-792-4338

#### Atlanta

500 Sugar Mill Road, Suite 200B  
Atlanta, GA 30350  
Tel: 770-640-0034 Fax: 770-640-0307

#### Boston

2 Lan Drive, Suite 120  
Westford, MA 01886  
Tel: 978-692-3848 Fax: 978-692-3821

#### Chicago

333 Pierce Road, Suite 180  
Itasca, IL 60143  
Tel: 630-285-0071 Fax: 630-285-0075

#### Dallas

4570 Westgrove Drive, Suite 160  
Addison, TX 75001  
Tel: 972-818-7423 Fax: 972-818-2924

#### Detroit

Tri-Atria Office Building  
32255 Northwestern Highway, Suite 190  
Farmington Hills, MI 48334  
Tel: 248-538-2250 Fax: 248-538-2260

#### Kokomo

2767 S. Albright Road  
Kokomo, Indiana 46902  
Tel: 765-864-8360 Fax: 765-864-8387

#### Los Angeles

18201 Von Karman, Suite 1090  
Irvine, CA 92612  
Tel: 949-263-1888 Fax: 949-263-1338

#### New York

150 Motor Parkway, Suite 202  
Hauppauge, NY 11788  
Tel: 631-273-5305 Fax: 631-273-5335

#### San Jose

Microchip Technology Inc.  
2107 North First Street, Suite 590  
San Jose, CA 95131  
Tel: 408-436-7950 Fax: 408-436-7955

#### Toronto

6285 Northam Drive, Suite 108  
Mississauga, Ontario L4V 1X5, Canada  
Tel: 905-673-0699 Fax: 905-673-6509

### ASIA/PACIFIC

#### Australia

Microchip Technology Australia Pty Ltd  
Suite 22, 41 Rawson Street  
Epping 2121, NSW  
Australia  
Tel: 61-2-9868-6733 Fax: 61-2-9868-6755

#### China - Beijing

Microchip Technology Consulting (Shanghai)  
Co., Ltd., Beijing Liaison Office  
Unit 915  
Bei Hai Wan Tai Bldg.  
No. 6 Chaoyangmen Beidajie  
Beijing, 100027, No. China  
Tel: 86-10-85282100 Fax: 86-10-85282104

#### China - Chengdu

Microchip Technology Consulting (Shanghai)  
Co., Ltd., Chengdu Liaison Office  
Rm. 2401, 24th Floor,  
Ming Xing Financial Tower  
No. 88 TIDU Street  
Chengdu 610016, China  
Tel: 86-28-86766200 Fax: 86-28-86766599

#### China - Fuzhou

Microchip Technology Consulting (Shanghai)  
Co., Ltd., Fuzhou Liaison Office  
Unit 28F, World Trade Plaza  
No. 71 Wusi Road  
Fuzhou 350001, China  
Tel: 86-591-7503506 Fax: 86-591-7503521

#### China - Shanghai

Microchip Technology Consulting (Shanghai)  
Co., Ltd.  
Room 701, Bldg. B  
Far East International Plaza  
No. 317 Xian Xia Road  
Shanghai, 200051  
Tel: 86-21-6275-5700 Fax: 86-21-6275-5060

#### China - Shenzhen

Microchip Technology Consulting (Shanghai)  
Co., Ltd., Shenzhen Liaison Office  
Rm. 1315, 13/F, Shenzhen Kerry Centre,  
Renminnan Lu  
Shenzhen 518001, China  
Tel: 86-755-82350361 Fax: 86-755-82366086

#### China - Hong Kong SAR

Microchip Technology Hongkong Ltd.  
Unit 901-6, Tower 2, Metroplaza  
223 Hing Fong Road  
Kwai Fong, N.T., Hong Kong  
Tel: 852-2401-1200 Fax: 852-2401-3431

#### India

Microchip Technology Inc.  
India Liaison Office  
Divyasree Chambers  
1 Floor, Wing A (A3/A4)  
No. 11, O'Shaugnessey Road  
Bangalore, 560 025, India  
Tel: 91-80-2290061 Fax: 91-80-2290062

### Japan

Microchip Technology Japan K.K.  
Benex S-1 6F  
3-18-20, Shinyokohama  
Kohoku-Ku, Yokohama-shi  
Kanagawa, 222-0033, Japan  
Tel: 81-45-471- 6166 Fax: 81-45-471-6122

### Korea

Microchip Technology Korea  
168-1, Youngbo Bldg. 3 Floor  
Samsung-Dong, Kangnam-Ku  
Seoul, Korea 135-882  
Tel: 82-2-554-7200 Fax: 82-2-558-5934

### Singapore

Microchip Technology Singapore Pte Ltd.  
200 Middle Road  
#07-02 Prime Centre  
Singapore, 188980  
Tel: 65-6334-8870 Fax: 65-6334-8850

### Taiwan

Microchip Technology (Barbados) Inc.,  
Taiwan Branch  
11F-3, No. 207  
Tung Hua North Road  
Taipei, 105, Taiwan  
Tel: 886-2-2717-7175 Fax: 886-2-2545-0139

### EUROPE

#### Austria

Microchip Technology Austria GmbH  
Durisolstrasse 2  
A-4600 Wels  
Austria  
Tel: 43-7242-2244-399  
Fax: 43-7242-2244-393

#### Denmark

Microchip Technology Nordic ApS  
Regus Business Centre  
Lautrup høj 1-3  
Ballerup DK-2750 Denmark  
Tel: 45 4420 9895 Fax: 45 4420 9910

#### France

Microchip Technology SARL  
Parc d'Activite du Moulin de Massy  
43 Rue du Saule Trapu  
Batiment A - 1er Etage  
91300 Massy, France  
Tel: 33-1-69-53-63-20 Fax: 33-1-69-30-90-79

#### Germany

Microchip Technology GmbH  
Steinheilstrasse 10  
D-85737 Ismaning, Germany  
Tel: 49-89-627-144 0 Fax: 49-89-627-144-44

#### Italy

Microchip Technology SRL  
Centro Direzionale Colleoni  
Palazzo Taurus 1 V. Le Colleoni 1  
20041 Agrate Brianza  
Milan, Italy  
Tel: 39-039-65791-1 Fax: 39-039-6899883

#### United Kingdom

Microchip Ltd.  
505 Eskdale Road  
Winkers Triangle  
Wokingham  
Berkshire, England RG41 5TU  
Tel: 44 118 921 5869 Fax: 44-118 921-5820

08/01/02