

SMD SHIELDED POWER INDUCTOR

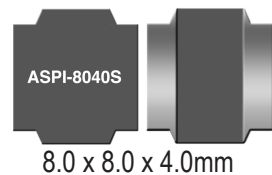

ASPI-8040S



RoHS
Compliant

FEATURES:

- Shielded magnetics, low radiation
- Large Terminal surface for good PCB bonding
- Low DCR, High Energy storage, suitable for large currents
- Ideal for a variety of DC-DC converter inductor applications

APPLICATIONS:

- Partable communication equipment
- OA equipment
- LCD, DVD, modem, set-top box
- DC/DC converters

ELECTRICAL SPECIFICATIONS:

Abracon P/N:	ASPI-8040S Series
Operating Temperature:	-25°C to +120°C
Storage Temperature:	-10°C to +40°C and 70% R.H.

Part Number	Inductance	L Tolerance	Inductance Test Condition	DC Resistance (N)	Saturation Current	Temperature Rise Current	Min. Self-resonant frequency	Marking
Units	µH	—	—	Ω	A	A	MHz	—
Symbol	L	—	—	DCR	Isat	I_{rms}	SRF	—
ASPI-8040S-1R0N	1.0	N	100KHz, 1v	0.008	9.85	6.30	89	1R0
ASPI-8040S-1R5N	1.5	N	100KHz, 1v	0.010	8.15	5.65	67	1R5
ASPI-8040S-2R0N	2.0	N	100KHz, 1v	0.012	9.25	5.15	43	2R0
ASPI-8040S-2R2N	2.2	N	100KHz, 1v	0.012	7.10	5.15	41	2R2
ASPI-8040S-3R0N	3.0	N	100KHz, 1v	0.014	6.10	4.70	32	3R0
ASPI-8040S-3R6N	3.6	N	100KHz, 1v	0.017	5.75	4.35	26	3R6
ASPI-8040S-3R9N	3.9	N	100KHz, 1v	0.017	5.75	4.35	26	3R9
ASPI-8040S-6R2N	6.2	N	100KHz, 1v	0.021	4.45	3.85	20	6R2
ASPI-8040S-6R8N	6.8	N	100KHz, 1v	0.024	4.55	3.60	20	6R8
ASPI-8040S-8R2N	8.2	N	100KHz, 1v	0.026	4.20	3.45	17	8R2
ASPI-8040S-100M	10	M	100KHz, 1v	0.029	3.60	3.30	15	100
ASPI-8040S-150M	15	M	100KHz, 1v	0.047	2.95	2.60	12	150
ASPI-8040S-180M	18	M	100KHz, 1v	0.053	2.70	2.40	11	180
ASPI-8040S-220M	22	M	100KHz, 1v	0.069	2.40	2.10	9.5	220
ASPI-8040S-270M	27	M	100KHz, 1v	0.078	2.15	2.00	9.2	270
ASPI-8040S-330M	33	M	100KHz, 1v	0.097	2.05	1.80	7.8	330
ASPI-8040S-360M	36	M	100KHz, 1v	0.102	2.00	1.75	7.8	360
ASPI-8040S-390M	39	M	100KHz, 1v	0.107	1.95	1.70	7.8	390
ASPI-8040S-430M	43	M	100KHz, 1v	0.113	1.90	1.65	7.8	430
ASPI-8040S-470M	47	M	100KHz, 1v	0.136	1.75	1.55	6.4	470
ASPI-8040S-510M	51	M	100KHz, 1v	0.142	1.70	1.50	6.4	510
ASPI-8040S-560M	56	M	100KHz, 1v	0.148	1.55	1.45	6.4	560
ASPI-8040S-620M	62	M	100KHz, 1v	0.182	1.50	1.30	6.4	620
ASPI-8040S-680M	68	M	100KHz, 1v	0.196	1.45	1.25	4.9	680
ASPI-8040S-750M	75	M	100KHz, 1v	0.211	1.35	1.20	4.9	750
ASPI-8040S-910M	91	M	100KHz, 1v	0.272	1.20	1.05	4.9	910
ASPI-8040S-101M	100	M	100KHz, 1v	0.290	1.15	1.00	4.2	101
ASPI-8040S-121M	120	M	100KHz, 1v	0.334	1.05	0.95	3.5	121
ASPI-8040S-221M	220	M	100KHz, 1v	0.599	0.85	0.80	3.5	221
ASPI-8040S-331M	330	M	100KHz, 1v	0.889	0.68	0.64	2.8	331

Tolerance: N=±30%, M=±20%

Test conditions

- Ambient Temperature: 20±15 °C
- Relative Humidity: 65%±20%
- Air Pressure: 86KPa to 106KPa

Inductance (L): ZM2355 LCR meter or equivalent

Direct Current Resistance (DCR): HIOKI 3540 or equivalent

Saturation Current (Isat): Saturation current meter

Definition of saturation current (Isat): DC current at which the inductance drops approximate 30% from its value without current

Temperature rise current (I_{rms}): Electric Power, Electric current meter, Thermometer

ABRACON IS
ISO9001:2008
CERTIFIED

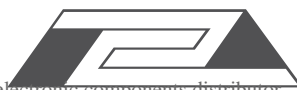

ABRACON
CORPORATION

Visit www.abracon.com for Terms & Conditions of Sale **Revised: 04.06.10**
30332 Esperanza, Rancho Santa Margarita, California 92688
tel 949-546-8000 | fax 949-546-8001 | www.abracon.com

SMD SHIELDED POWER INDUCTOR

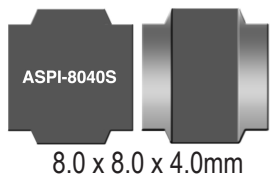

ASPI-8040S



RoHS
Compliant

OPTIONS AND PART IDENTIFICATION

ASPI-8040S - - -

Inductance Code
Please refer to the table on Page 2

Tolerance
M: $\pm 20\%$
or
N: $\pm 30\%$

Packaging
Blank: Bulk
T: Tape and Reel

OUTLINE DRAWING:

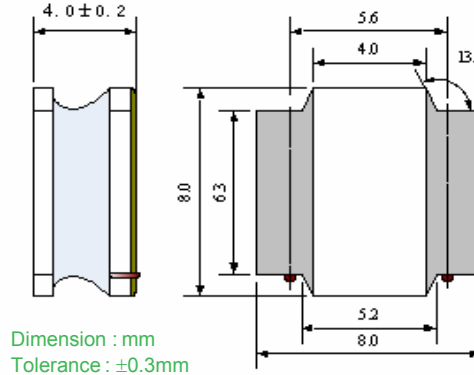
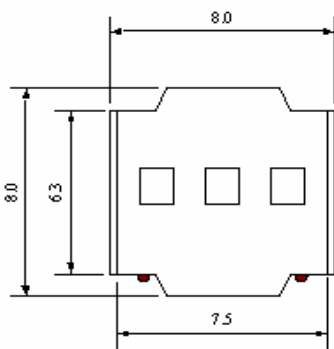

Dimension : mm
Tolerance : $\pm 0.3\text{mm}$

Recommended Land Pattern

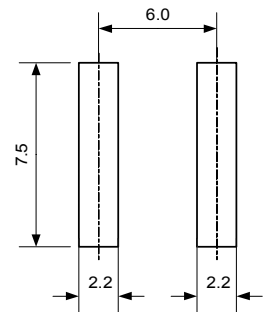

TAPE & REEL:

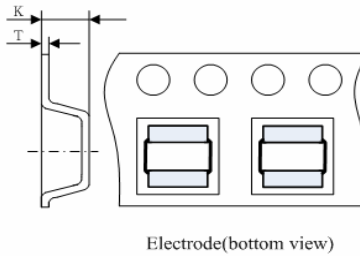
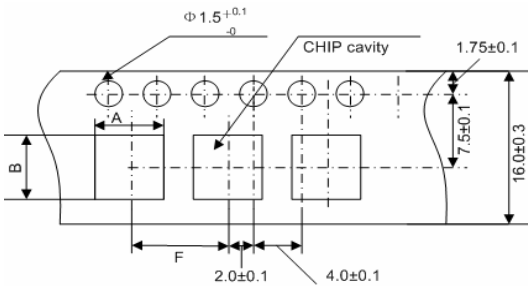

Electrode(bottom view)

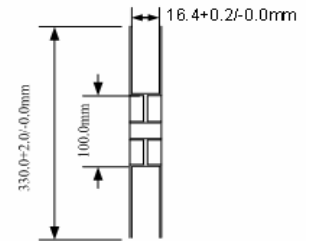
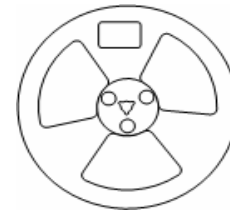

A	B	F	K	T
8.35 ± 0.10	8.35 ± 0.10	12.0 ± 0.10	4.4 ± 0.10	0.40 ± 0.03

Unit: mm

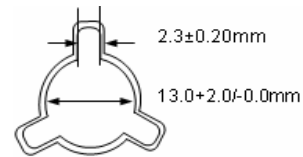

REFLOW PROFILE:

6.1 Reflow Profile

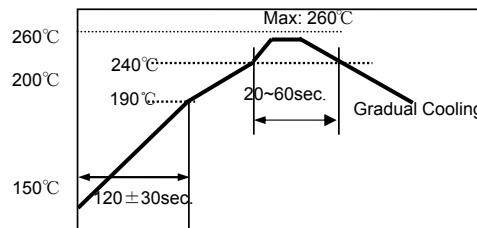

1~2 °C/sec. Ramp
Pre-heating: 150~190°C/120 ± 30 sec.
Time above 240°C: 20~60sec
Peak temperature: 260°C Max/10sec.
Solder paste: Sn/3.0Ag/0.5Cu
Max.2 times for re-flowing

NOTE: Abracon manufactured products are intended for general commercial and industrial use. For applications requiring high reliability and/or presenting extreme operating environment, written consent & authorization from Abracon is required.

ABRACON IS
ISO9001:2008
CERTIFIED

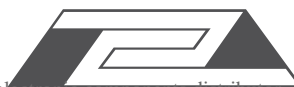

ABRACON
CORPORATION

Visit www.abracon.com for Terms & Conditions of Sale **Revised: 04.06.09**
30332 Esperanza, Rancho Santa Margarita, California 92688
tel 949-546-8000 | fax 949-546-8001 | www.abracon.com