

UNSHIELDED SMD POWER INDUCTOR

AISC-1812H

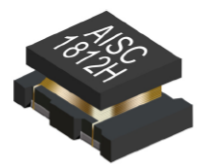

4.5 x 3.2 x 2.6mm

RoHS
Compliant

FEATURES:

- Excellent solderability and resistance
- Suitable for flow and reflow soldering
- Packed in embossed carrier tape and can be used by automatic mounting machines

STANDARD SPECIFICATIONS:

PARAMETERS

ABRACON P/N:	AISC-1812H-xxx Series
Operating temperature:	-25°C to + 85°C
Storage temperature:	-25°C to + 85°C, 70% RH max.

Part Number	Test Condition (V/Hz)	L (μH)	DC Resistance (Ω) Max.	SRF (MHz) Min	I _r (A) Max
AISC-1812H-1R0N	1.0 / 1.0M	1.0	0.08	120	1.08
AISC-1812H-1R5N	1.0 / 1.0M	1.5	0.09	85	1.00
AISC-1812H-1R8N	1.0 / 1.0M	1.8	0.10	75	0.96
AISC-1812H-2R2N	1.0 / 1.0M	2.2	0.11	62	0.90
AISC-1812H-2R7N	1.0 / 1.0M	2.7	0.12	53	0.87
AISC-1812H-3R3N	1.0 / 1.0M	3.3	0.13	47	0.80
AISC-1812H-3R9N	1.0 / 1.0M	3.9	0.15	41	0.78
AISC-1812H-4R7N	1.0 / 1.0M	4.7	0.20	38	0.75
AISC-1812H-5R6N	1.0 / 1.0M	5.6	0.23	33	0.73
AISC-1812H-6R8N	1.0 / 1.0M	6.8	0.25	31	0.72
AISC-1812H-8R2N	1.0 / 1.0M	8.2	0.27	27	0.68
AISC-1812H-100K	1.0 / 1.0M	10	0.35	23	0.65
AISC-1812H-120K	1.0 / 1.0M	12	0.47	21	0.62
AISC-1812H-150K	1.0 / 1.0M	15	0.54	19	0.57
AISC-1812H-180K	1.0 / 1.0M	18	0.56	17	0.48
AISC-1812H-220K	1.0 / 1.0M	22	0.64	15	0.42
AISC-1812H-270K	1.0 / 100K	27	0.75	14	0.37
AISC-1812H-330K	1.0 / 100K	33	0.86	12	0.31
AISC-1812H-390K	1.0 / 100K	39	1.18	11	0.30
AISC-1812H-470K	1.0 / 100K	47	1.37	10	0.28
AISC-1812H-560K	1.0 / 100K	56	1.56	9.3	0.25
AISC-1812H-680K	1.0 / 100K	68	1.92	8.4	0.22
AISC-1812H-820K	1.0 / 100K	82	2.08	7.5	0.20
AISC-1812H-101K	1.0 / 100K	100	2.96	6.8	0.19
AISC-1812H-121K	1.0 / 100K	120	3.20	6.2	0.17
AISC-1812H-151K	1.0 / 100K	150	3.72	5.5	0.13
AISC-1812H-181K	1.0 / 100K	180	5.16	5	0.12
AISC-1812H-221K	1.0 / 100K	220	5.90	4.5	0.11
AISC-1812H-271K	1.0 / 100K	270	6.55	4	0.105
AISC-1812H-331K	1.0 / 100K	330	7.75	3.6	0.100
AISC-1812H-391K	1.0 / 100K	390	8.06	3.3	0.095
AISC-1812H-471K	1.0 / 1.0K	470	12.50	3	0.090
AISC-1812H-561K	1.0 / 1.0K	560	13.00	2.7	0.070
AISC-1812H-681K	1.0 / 1.0K	680	14.60	2.5	0.065
AISC-1812H-821K	1.0 / 1.0K	820	16.80	2.2	0.060
AISC-1812H-102K	1.0 / 1.0K	1000	26.40	2	0.050
AISC-1812H-122K	1.0 / 1.0K	1200	48.00	1.8	0.045
AISC-1812H-152K	1.0 / 1.0K	1500	52.20	1.6	0.040
AISC-1812H-182K	1.0 / 1.0K	1800	58.80	1.5	0.035
AISC-1812H-222K	1.0 / 1.0K	2200	65.00	1.3	0.030

Inductance tolerance: N: ±30%; K: ±10%

APPLICATIONS:

- Excellent for power line DC/DC conversion application
- Used in hard disk, notebook computer and other electronic equipment

OPTIONS & PART IDENTIFICATION:

(Left blank if standard)

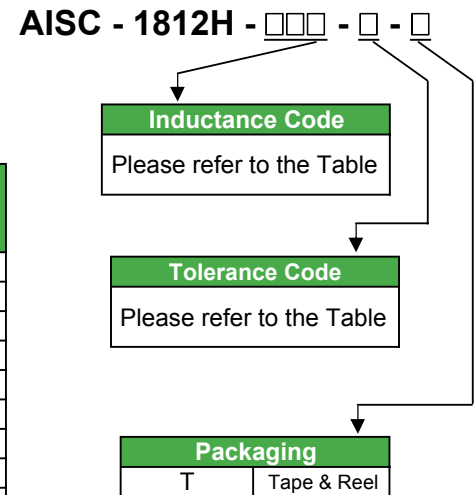

Test Equipment and Conditions:

I_r: Rated current that will cause initial inductance value approximately 10% rolloff or coil temperature rise by 40°C without core loss, which ever is smaller. (Reference ambient temperature 2 °C).

L: measured with CH-1061 with 1320

SRF: measured with HP-8714C RF network analyzer

ABRACON IS
ISO9001:2008
CERTIFIED

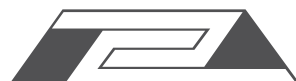

ABRACON
CORPORATION

Visit www.abracon.com for Terms & Conditions of Sale **Revised: 07.15.10**
30332 Esperanza, Rancho Santa Margarita, California 92688
tel 949-546-8000 | fax 949-546-8001 | www.abracon.com

UNSHIELDED SMD POWER INDUCTOR

AISC-1812H



RoHS
Compliant

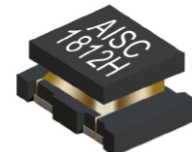

4.5 x 3.2 x 2.6mm

OUTLINE DRAWING:

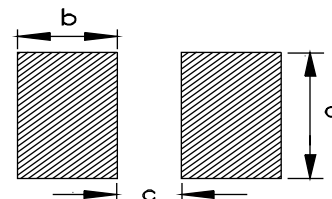
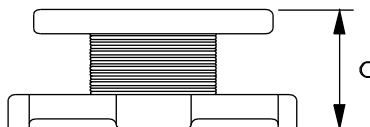
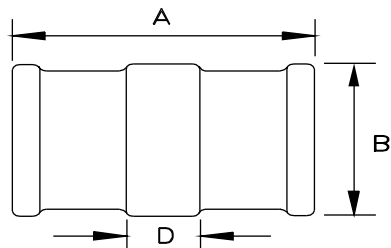

Recommended Land Pattern

Series	A	B	C	D(ref)	a(ref)	b(ref)	c(ref)
AISC-1812H	0.177±0.012 (4.5 ±0.3)	0.126±0.008 (3.2 ±0.2)	0.102±0.008 (2.6 ±0.2)	0.06 (1.5)	0.15 (3.8)	0.071 (1.8)	0.059 (1.5)

Dimensions: Inches (mm)

TAPE & REEL: Tape and reel 500 pcs/reel

Dimensions of Tape

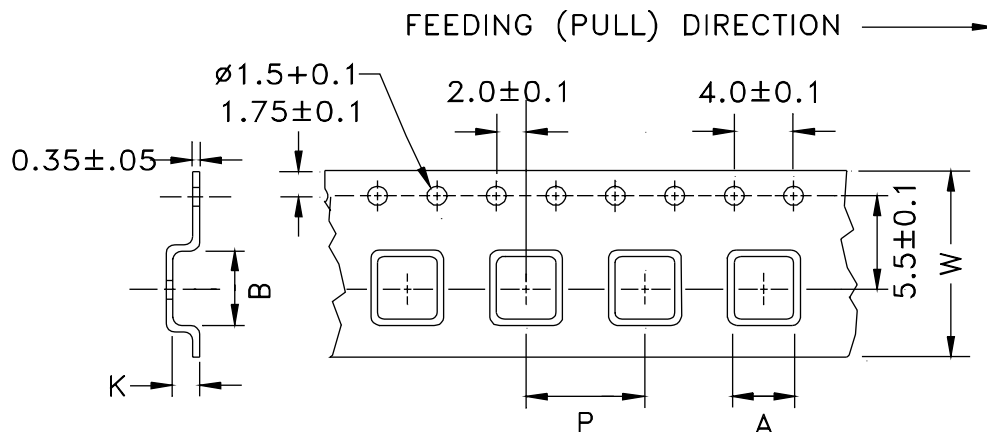

ABRACON P/N	A (mm)	B (mm)	K (mm)	P (mm)	W (mm)
AISC-1812H	3.65 ± 0.1	5.05 ± 0.1	3.1 ± 0.1	8.0 ± 0.1	12.0 ± 0.3

Dimensions of Reel

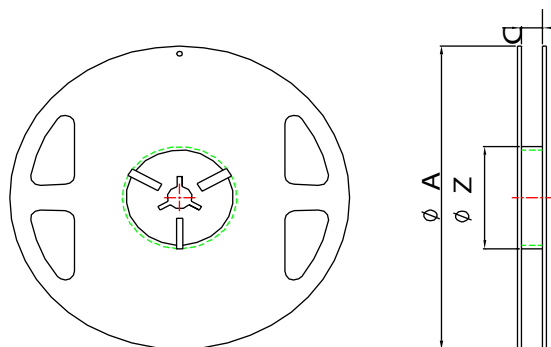

Series	A	C	Z
ASPI-1812H	330	12.0 ± 0.5	60±0.5

Dimensions: mm

ATTENTION: Abracon Corporation's products are COTS – Commercial-Off-The-Shelf products; suitable for Commercial, Industrial and, where designated, Automotive Applications. Abracon's products are not specifically designed for Military, Aviation, Aerospace, Life-dependant Medical applications or any application requiring high reliability where component failure could result in loss of life and/or property. For applications requiring high reliability and/or presenting an extreme operating environment, written consent and authorization from Abracon Corporation is required. Please contact Abracon Corporation for more information.

ABRACON IS
ISO9001:2008
CERTIFIED



ABRACON
CORPORATION

Visit www.abracon.com for Terms & Conditions of Sale **Revised: 07.15.10**
30332 Esperanza, Rancho Santa Margarita, California 92688
tel 949-546-8000 | fax 949-546-8001 | www.abracon.com