

# SMD Inductors(Coils) For Signal Line(Multilayer, Magnetic Shielded)

Conformity to RoHS Directive

## MLF Series MLF2012-J

Since digital devices have become faster and have more functions, stricter inductance tolerance has become necessary in the high frequency range.

The ferrite material and internal electrodes for MLF2012-J tolerance products have been newly developed and have received optimal process design. As a result, tolerance could be narrowed ( $\pm 5\%$ ) to half of the previous MLF series, and drift variance was also been greatly improved.

### FEATURES

- Inductance tolerance is  $\pm 5\%$  (J-tolerance)
- Temperature stress (drift variance percentage) for soldering is  $\pm 3\%$ , which is an improvement of 1/3 over the previous product.
- The products contain no lead and also support lead-free soldering.
- It is a product conforming to RoHS directive.

### APPLICATIONS

Signal processing such as car audio, automotive (intended) use, tuner.

### SPECIFICATIONS

Operating temperature range	-55 to +125°C
Storage temperature range	-55 to +125°C

### RECOMMENDED SOLDERING CONDITION

#### REFLOW SOLDERING

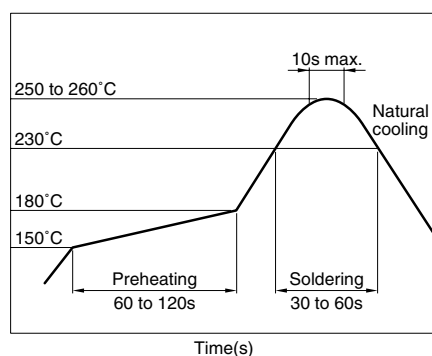

### PRODUCT IDENTIFICATION

MLF	2012	A	1R0	J	T
(1)	(2)	(3)	(4)	(5)	(6)

(1) Series name

(2) Dimensions L×W

2012	2.0×1.25mm
------	------------

(3) Material code

(4) Inductance value

R10	0.1μH
1R0	1.0μH
100	10μH

(5) Inductance tolerance

J	$\pm 5\%$
---	-----------

(6) Packaging style

T	Taping [reel]
---	---------------

### PACKAGING STYLE AND QUANTITIES

Packaging style	Product's thickness T	Quantity
Taping	0.85mm	4000 pieces/reel
	1.25mm	2000 pieces/reel

### HANDLING AND PRECAUTIONS

- Before soldering, be sure to preheat components. The preheating temperature should be set so that the temperature difference between the solder temperature and product temperature does not exceed 150°C.
- After mounting components onto the printed circuit board, do not apply stress through board bending or mishandling.
- The inductance value may change due to magnetic saturation if the current exceeds the rated maximum.
- Do not expose the inductors to stray magnetic fields.
- Avoid static electricity discharge during handling.
- When hand soldering, apply the soldering iron to the printed circuit board only. Temperature of the iron tip should not exceed 350°C. Soldering time should not exceed 3 seconds.

• Conformity to RoHS Directive: This means that, in conformity with EU Directive 2002/95/EC, lead, cadmium, mercury, hexavalent chromium, and specific bromine-based flame retardants, PBB and PBDE, have not been used, except for exempted applications.

• Please contact our Sales office when your application are considered the following:  
The device's failure or malfunction may directly endanger human life (e.g. application for automobile/aircraft/medical/nuclear power devices, etc.)

• All specifications are subject to change without notice.

## SHAPES AND DIMENSIONS/RECOMMENDED PC BOARD PATTERN

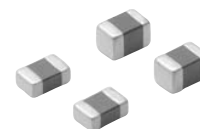
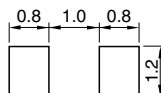
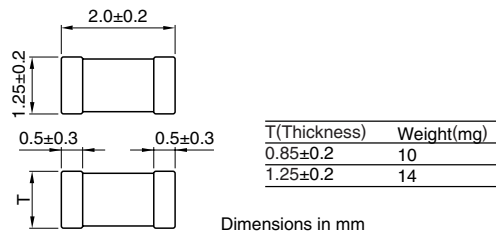

## ELECTRICAL CHARACTERISTICS

Inductance (μH)	Inductance tolerance	Q		Test frequency L, Q (MHz)	Test current L, Q (mA)	Self-resonant frequency (MHz)		DC resistance (Ω)		Rated current (mA)max.	Thickness T (mm)	Part No.
		min.	typ.			min.	typ.	max.	typ.			
0.1	±5%	20	30	25	1.0	400	500	0.15	0.10	300	0.85±0.2	MLF2012DR10J
0.12	±5%	20	30	25	1.0	360	450	0.20	0.12	300	0.85±0.2	MLF2012DR12J
0.15	±5%	20	30	25	1.0	320	410	0.20	0.13	300	0.85±0.2	MLF2012DR15J
0.18	±5%	20	30	25	1.0	280	370	0.25	0.15	300	0.85±0.2	MLF2012DR18J
0.22	±5%	20	30	25	1.0	250	330	0.30	0.16	250	0.85±0.2	MLF2012DR22J
0.27	±5%	20	30	25	1.0	220	300	0.35	0.18	250	0.85±0.2	MLF2012DR27J
0.33	±5%	20	30	25	1.0	200	270	0.40	0.23	250	0.85±0.2	MLF2012DR33J
0.39	±5%	25	35	25	1.0	180	250	0.45	0.25	200	0.85±0.2	MLF2012DR39J
0.47	±5%	25	35	25	1.0	160	230	0.50	0.25	200	1.25±0.2	MLF2012DR47J
0.56	±5%	25	35	25	1.0	150	210	0.55	0.30	150	1.25±0.2	MLF2012DR56J
0.68	±5%	25	35	25	1.0	140	190	0.60	0.35	150	1.25±0.2	MLF2012DR68J
0.82	±5%	25	35	25	1.0	130	170	0.65	0.40	150	1.25±0.2	MLF2012DR82J
1	±5%	45	55	10	1.0	120	160	0.30	0.15	80	0.85±0.2	MLF2012A1R0J
1.2	±5%	45	55	10	1.0	110	150	0.35	0.15	80	0.85±0.2	MLF2012A1R2J
1.5	±5%	45	60	10	1.0	100	140	0.40	0.18	80	0.85±0.2	MLF2012A1R5J
1.8	±5%	45	60	10	1.0	90	130	0.45	0.20	80	0.85±0.2	MLF2012A1R8J
2.2	±5%	45	60	10	1.0	80	120	0.50	0.22	50	0.85±0.2	MLF2012A2R2J
2.7	±5%	45	70	10	1.0	70	100	0.55	0.25	50	1.25±0.2	MLF2012A2R7J
3.3	±5%	45	70	10	1.0	60	90	0.60	0.28	50	1.25±0.2	MLF2012A3R3J
3.9	±5%	45	70	10	1.0	55	80	0.65	0.30	30	1.25±0.2	MLF2012A3R9J
4.7	±5%	45	70	10	1.0	50	70	0.70	0.35	30	1.25±0.2	MLF2012A4R7J
5.6	±5%	50	75	4	0.1	45	65	0.60	0.30	15	1.25±0.2	MLF2012E5R6J
6.8	±5%	50	75	4	0.1	40	60	0.65	0.32	15	1.25±0.2	MLF2012E6R8J
8.2	±5%	50	75	4	0.1	35	55	0.70	0.35	15	1.25±0.2	MLF2012E8R2J
10	±5%	50	75	2	0.1	30	50	0.80	0.40	15	1.25±0.2	MLF2012E100J
12	±5%	50	75	2	0.1	25	45	0.90	0.50	15	1.25±0.2	MLF2012E120J

- Test equipment  
Inductance, Q: Ag4294A-16034G

## TYPICAL ELECTRICAL CHARACTERISTICS

### Q vs. FREQUENCY CHARACTERISTICS

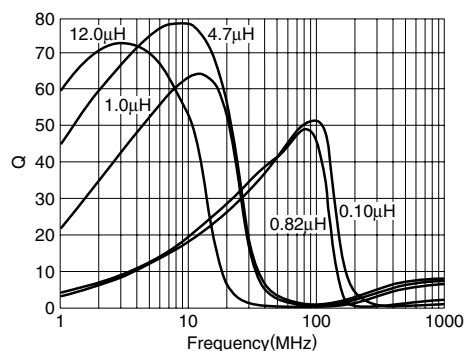

### IMPEDANCE vs. FREQUENCY CHARACTERISTICS

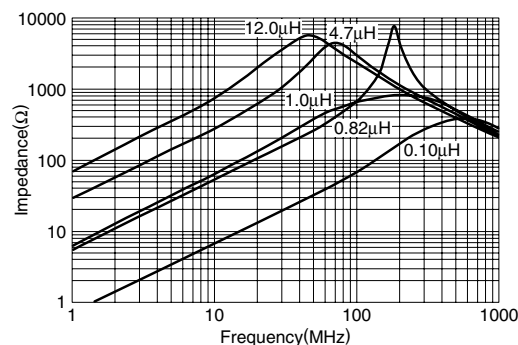

- All specifications are subject to change without notice.

### PACKAGING STYLES REEL DIMENSIONS

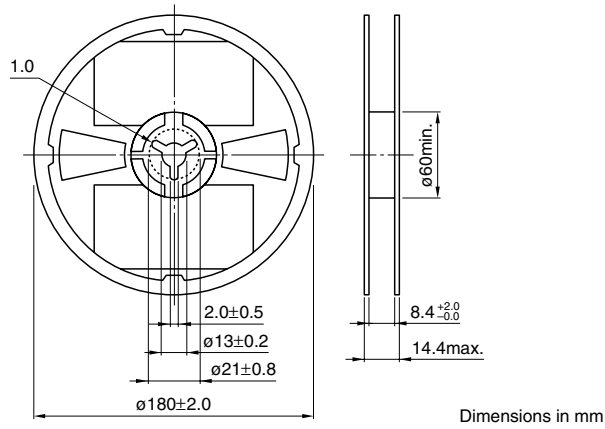

### TAPE DIMENSIONS

t=0.85mm

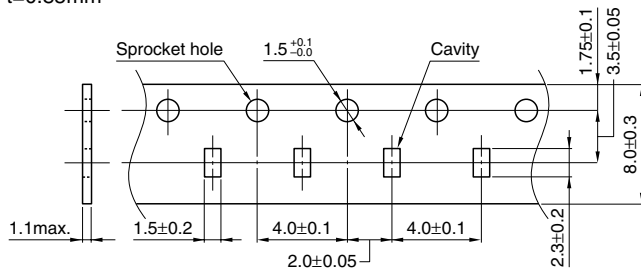

t=1.25mm

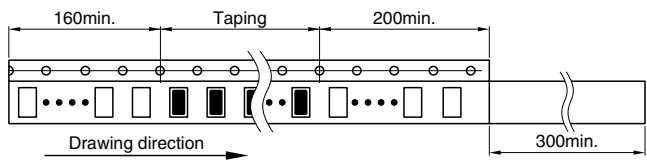
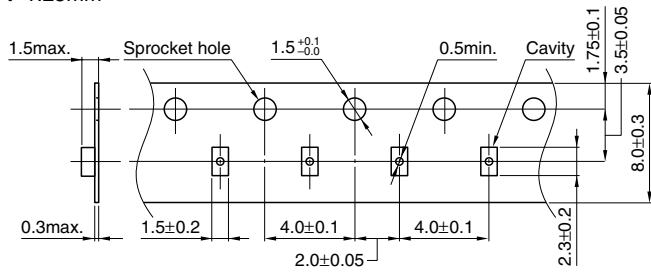

Dimensions in mm

• All specifications are subject to change without notice.