

# Notice for TAIYO YUDEN products

Please read this notice before using the TAIYO YUDEN products.

## REMINDERS

- Product information in this catalog is as of October 2010. All of the contents specified herein are subject to change without notice due to technical improvements, etc. Therefore, please check for the latest information carefully before practical application or usage of the Products.

Please note that Taiyo Yuden Co., Ltd. shall not be responsible for any defects in products or equipment incorporating such products, which are caused under the conditions other than those specified in this catalog or individual specification.

- Please contact Taiyo Yuden Co., Ltd. for further details of product specifications as the individual specification is available.
- Please conduct validation and verification of products in actual condition of mounting and operating environment before commercial shipment of the equipment.
- All electronic components or functional modules listed in this catalog are developed, designed and intended for use in general electronics equipment.(for AV, office automation, household, office supply, information service, telecommunications, (such as mobile phone or PC) etc.). Before incorporating the components or devices into any equipment in the field such as transportation,( automotive control, train control, ship control), transportation signal, disaster prevention, medical, public information network (telephone exchange, base station) etc. which may have direct influence to harm or injure a human body, please contact Taiyo Yuden Co., Ltd. for more detail in advance. Do not incorporate the products into any equipment in fields such as aerospace, aviation, nuclear control, submarine system, military, etc. where higher safety and reliability are especially required.

In addition, even electronic components or functional modules that are used for the general electronic equipment, if the equipment or the electric circuit require high safety or reliability function or performances, a sufficient reliability evaluation check for safety shall be performed before commercial shipment and moreover, due consideration to install a protective circuit is strongly recommended at customer's design stage.

- The contents of this catalog are applicable to the products which are purchased from our sales offices or distributors (so called "TAIYO YUDEN' s official sales channel"). It is only applicable to the products purchased from any of TAIYO YUDEN' s official sales channel.
- Please note that Taiyo Yuden Co., Ltd. shall have no responsibility for any controversies or disputes that may occur in connection with a third party's intellectual property rights and other related rights arising from your usage of products in this catalog. Taiyo Yuden Co., Ltd. grants no license for such rights.
- Caution for export**  
Certain items in this catalog may require specific procedures for export according to "Foreign Exchange and Foreign Trade Control Law" of Japan, "U.S. Export Administration Regulations", and other applicable regulations. Should you have any question or inquiry on this matter, please contact our sales staff.

# WOUND CHIP INDUCTORS (LB SERIES)

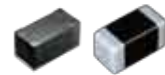

REFLOW

## FEATURES

LB-series are Wound Chip Inductors having wide line-up, which are suitable for any circuit designs.

- LBC series has large rated current. They contribute to the miniaturization of the power supply circuit.
- LBR series has low DC resistance. They contribute to the miniaturization of the power supply circuit.
- LBMF series has a low loss characteristic.

## APPLICATIONS

- They are suitable for an anti-noise measure on the power supply circuit of DSC, DVC, HDD, LCD-TV, mobile phones, PC, game equipments, various communication equipments and etc..

## OPERATING TEMP.

- -40 ~ 105°C (Including-self-generated heat)

## ORDERING CODE

L B △ 2 0 1 2 T 1 0 0 △ △ △ △ △

**1 Type**

LB	Wound chip inductor
----	---------------------

**2 Shape**

△	Standard products
C	High current
R	Low Rdc
MF	Low loss

**3 External Dimensions (mm)**

1608 (0603)	1.6×0.8
2012 (0805)	2.0×1.25
2016 (0806)	2.0×1.6
2518 (1007)	2.5×1.8
3218 (1207)	3.2×1.8
3225 (1210)	3.2×2.5

**4 Packaging**

T	Tape & Reel
---	-------------

**5 Nominal Inductance [μH]**

example	
1R0	1
100	10
101	100

※R=decimal point

**6 Inductance Tolerances (%)**

K	±10
M	±20

**7 Special code**

△	Standard products
R	Low Rdc type

**8 Internal code**

△△△	Standard Products
-----	-------------------

△=Blank space

## EXTERNAL DIMENSIONS/STANDARD QUANTITY

### EXTERNAL DIMENSIONS

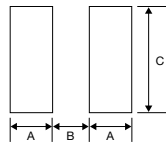
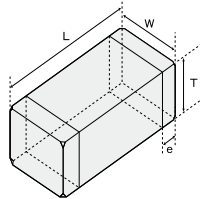

Unit : mm

TYPE	A	B	C
1608	0.55	0.7	0.9
MF1608	0.55	0.7	1.0
2012	0.60	1.0	1.45
2016	0.60	1.0	1.8
2518	0.60	1.5	2.0
3218	0.85	1.7	2.0
3225	0.85	1.7	2.7

- Surface Mounting
- Mounting and soldering conditions should be checked beforehand.
  - Applicable soldering process to those products is reflow soldering only.
  - Recommended Land Patterns

Type	L	W	T	e	Standard Quantity [pcs]	
					Paper Tape	Embossed Tape
LB1608	1.6±0.1 (0.063±0.004)	0.8±0.1 (0.031±0.004)	0.8±0.1 (0.031±0.004)	0.35±0.15 (0.014±0.006)	4000	—
LBMF1608	1.6±0.2 (0.063±0.008)	0.8±0.2 (0.031±0.008)	0.8±0.2 (0.031±0.008)	0.45±0.15 (0.016±0.006)	—	3000
LB2012	2.0±0.2 (0.079±0.008)	1.25±0.2 (0.049±0.008)	1.25±0.2 (0.049±0.008)	0.5±0.2 (0.020±0.008)	—	3000
LBC2012	2.0±0.2 (0.079±0.008)	1.6±0.2 (0.063±0.008)	1.6±0.2 (0.063±0.008)	0.5±0.2 (0.020±0.008)	—	2000
LBR2012	2.0±0.2 (0.079±0.008)	1.6±0.2 (0.063±0.008)	1.6±0.2 (0.063±0.008)	0.5±0.2 (0.020±0.008)	—	2000
LB2518	2.5±0.2 (0.098±0.008)	1.8±0.2 (0.071±0.008)	1.8±0.2 (0.071±0.008)	0.5±0.2 (0.020±0.008)	—	2000
LBC2518	2.5±0.2 (0.098±0.008)	1.8±0.2 (0.071±0.008)	1.8±0.2 (0.071±0.008)	0.5±0.2 (0.020±0.008)	—	2000
LBR2518	2.5±0.2 (0.098±0.008)	1.8±0.2 (0.071±0.008)	1.8±0.2 (0.071±0.008)	0.5±0.2 (0.020±0.008)	—	2000
LB3218	3.2±0.2 (0.128±0.008)	1.8±0.2 (0.071±0.008)	1.8±0.2 (0.071±0.008)	0.6±0.2 (0.024±0.008)	—	2000
LBC3218	3.2±0.2 (0.128±0.008)	2.5±0.2 (0.098±0.008)	2.5±0.2 (0.098±0.008)	0.6±0.3 (0.024±0.012)	—	1000
LBR3218	3.2±0.2 (0.128±0.008)	2.5±0.2 (0.098±0.008)	2.5±0.2 (0.098±0.008)	0.6±0.3 (0.024±0.012)	—	1000

Unit : mm (inch)

## AVAILABLE INDUCTANCE RANGE

Type Range	Type											
	LB1608	LBMF1608	LB2012	LBC2012	LBR2012	LB2016	LBC2016	LB2518	LBC2518	LBR2518	LB3218	LBC3225
Inductance [μH]	Imax [mA] Rdc ±30% [Ω]											
	160 1μH 0.17	230 1μH 0.09	405 1μH 0.15	620 1μH 0.19	400 1μH 0.07	490 1μH 0.09	690 1μH 0.1	665 1μH 0.06	775 1μH 0.08	960 1μH 0.045	1075 1μH 0.06	1100 1μH 0.055
	70 0.55											
	60 0.7	80 0.36	120 0.7	200 1.2	150 0.36	155 0.5	245 0.82	165 0.25	375 0.36	235 0.19	340 0.25	540 0.133
10	10μH	35 2.5	90 5.8									
100		47μH	45 7.0	47μH	50 4.0	40 4.5	75 8.0	60 2.1	125 3.70	80 1.89	140 2.40	150 1.4
1000			100μH		100μH	100μH	100μH	15 24	45 28.0	100μH	39 27	1000μH

\* This catalog contains the typical specification only due to the limitation of space. When you consider the purchase of our products, please check our specification. For details of each product (characteristics graph, reliability information, precautions for use, and so on), see our Web site (<http://www.ty-top.com/>) or CD catalogs.

**PART NUMBERS**

**1608(0603) TYPE**

Ordering code	Inductance ( $\mu$ H)	Inductance Tolerance	Self-resonant frequency [MHz] min.	DC Resistance ( $\Omega$ ) ( $\pm 30\%$ )	Rated current [mA] max.	Measuring frequency [MHz]
LB 1608T1R0M	1.0	$\pm 20\%$	100	0.17	160	7.96
LB 1608T2R2M	2.2		80	0.33	115	
LB 1608T4R7M	4.7		45	0.55	70	
LB 1608T8R2M	8.2		32	0.70	60	
LB 1608T100M	10		32	0.70	60	2.52

Ordering code	Inductance ( $\mu$ H)	Inductance Tolerance	Self-resonant frequency [MHz] min.	DC Resistance ( $\Omega$ ) ( $\pm 30\%$ )	Rated current [mA] max.	Measuring frequency [MHz]
LBMF1608T1R0M	1.0	$\pm 20\%$	100	0.09	230	7.96
LBMF1608T2R2M	2.2		80	0.17	160	
LBMF1608T3R3M	3.3		60	0.22	130	
LBMF1608T4R7M	4.7		45	0.24	110	
LBMF1608T100□	10	$\pm 10\%$ $\pm 20\%$	32	0.36	80	2.52
LBMF1608T220□	22		16	1.00	50	
LBMF1608T470□	47		11	2.50	35	

□ Please specify the Inductance tolerance code (K or M)

**2012(0805) TYPE**

Ordering code	Inductance ( $\mu$ H)	Inductance Tolerance	Self-resonant frequency [MHz] min.	DC Resistance ( $\Omega$ ) ( $\pm 30\%$ )	Rated current [mA] max.	Measuring frequency [MHz]
LB 2012T1R0M	1.0	$\pm 20\%$	100	0.15	405	7.96
LB 2012T2R2M	2.2		80	0.23	260	
LB 2012T3R3M	3.3		55	0.30	235	
LB 2012T4R7M	4.7		45	0.40	190	
LB 2012T6R8M	6.8	$\pm 10\%$ $\pm 20\%$	38	0.47	135	2.52
LB 2012T100□	10		32	0.7	120	
LB 2012T100□R	10		32	0.5	120	
LB 2012T150□	15		28	1.3	100	
LB 2012T220□	22		16	1.7	80	
LB 2012T470□	47		11	3.7	60	
LB 2012T680□	68		10	6.0	50	
LB 2012T101□	100	8	7.0	45	0.796	

□ Please specify the Inductance tolerance code (K or M)

Ordering code	Inductance ( $\mu$ H)	Inductance Tolerance	Self-resonant frequency [MHz] min.	DC Resistance ( $\Omega$ ) ( $\pm 30\%$ )	Rated current [mA] max.	Measuring frequency [MHz]
LB C2012T1R0M	1.0	$\pm 20\%$	100	0.19	620	7.96
LB C2012T2R2M	2.2		70	0.33	430	
LB C2012T4R7M	4.7		45	0.5	295	
LB C2012T100□	10	$\pm 10\%$ $\pm 20\%$	40	1.2	200	2.52
LB C2012T220□	22		16	3.7	130	
LB C2012T470□	47		11	5.8	90	

□ Please specify the Inductance tolerance code (K or M)

Ordering code	Inductance ( $\mu$ H)	Inductance Tolerance	Self-resonant frequency [MHz] min.	DC Resistance ( $\Omega$ ) ( $\pm 30\%$ )	Rated current [mA] max.	Measuring frequency [MHz]
LB R2012T1R0M	1.0	$\pm 20\%$	100	0.07	400	7.96
LB R2012T2R2M	2.2		80	0.13	260	
LB R2012T4R7M	4.7		45	0.24	200	
LB R2012T100□	10	$\pm 10\%$ $\pm 20\%$	32	0.36	150	2.52
LB R2012T220□	22		16	1	100	
LB R2012T470□	47		11	1.7	75	
LB R2012T101□	100		8	4	50	

□ Please specify the Inductance tolerance code (K or M)

**2016(0806) TYPE**

Ordering code	Inductance ( $\mu$ H)	Inductance Tolerance	Self-resonant frequency [MHz] min.	DC Resistance ( $\Omega$ ) ( $\pm 30\%$ )	Rated current [mA] max.	Measuring frequency [MHz]
LB 2016T1R0M	1.0	$\pm 20\%$	100	0.09	490	7.96
LB 2016T1R5M	1.5		80	0.11	380	
LB 2016T2R2M	2.2		70	0.13	375	
LB 2016T3R3M	3.3		55	0.20	285	
LB 2016T4R7M	4.7		45	0.25	225	
LB 2016T6R8M	6.8		38	0.35	200	
LB 2016T100□	10	$\pm 10\%$ $\pm 20\%$	32	0.50	155	2.52
LB 2016T150□	15		28	0.70	130	
LB 2016T220□	22		16	1.0	105	
LB 2016T330□	33		14	1.7	85	
LB 2016T470□	47		11	2.4	70	
LB 2016T680□	68		10	3.0	55	
LB 2016T101□	100		8	4.5	40	

□ Please specify the Inductance tolerance code (K or M)

\* This catalog contains the typical specification only due to the limitation of space. When you consider the purchase of our products, please check our specification. For details of each product (characteristics graph, reliability information, precautions for use, and so on), see our Web site (<http://www.ty-top.com/>) or CD catalogs.

**PART NUMBERS**

Ordering code	Inductance [ $\mu$ H]	Inductance Tolerance	Self-resonant frequency [MHz]min.	DC Resistance [ $\Omega$ ] ( $\pm 30\%$ )	Rated current [mA]max.	Measuring frequency [MHz]
LB C2016T1R0M	1.0	$\pm 20\%$	100	0.1	690	7.96
LB C2016T1R5M	1.5		80	0.15	600	
LB C2016T2R2M	2.2		70	0.2	520	
LB C2016T3R3M	3.3		55	0.27	410	
LB C2016T4R7M	4.7		45	0.37	355	
LB C2016T6R8M	6.8		38	0.59	290	
LB C2016T100□	10	$\pm 10\%$ $\pm 20\%$	32	0.82	245	2.52
LB C2016T150□	15		28	1.2	200	
LB C2016T220□	22		16	1.8	165	
LB C2016T330□	33		14	2.8	135	
LB C2016T470□	47		11	4.3	110	
LB C2016T680□	68		10	7	95	
LB C2016T101□	100		8	8	75	
LB C2016T101□	100		8	8	75	

□Please specify the Inductance tolerance code(K or M)

**2518(1007) TYPE**

Ordering code	Inductance [ $\mu$ H]	Inductance Tolerance	Self-resonant frequency [MHz]min.	DC Resistance [ $\Omega$ ] ( $\pm 30\%$ )	Rated current [mA]max.	Measuring frequency [MHz]	
LB 2518T1R0M	1.0	$\pm 20\%$	100	0.06	665	7.96	
LB 2518T1R5M	1.5		80	0.07	405		
LB 2518T2R2M	2.2		68	0.09	340		
LB 2518T3R3M	3.3		54	0.11	280		
LB 2518T4R7M	4.7		46	0.13	240		
LB 2518T4R7MR	4.7		46	0.10	235		
LB 2518T6R8M	6.8	38	0.15	195	2.52		
LB 2518T100□	10	30	0.25	165			
LB 2518T150□	15	23	0.32	145			
LB 2518T220□	22	19	0.50	115			
LB 2518T330□	33	15	0.70	95			
LB 2518T470□	47	12	0.95	85			
LB 2518T680□	68	9.5	1.50	70			
LB 2518T101□	100	9	2.10	60			
LB 2518T151□	150	$\pm 10\%$ $\pm 20\%$	7	3.20	45	0.796	
LB 2518T221□	220		5.5	4.50	40		
LB 2518T331□	330		4.5	7.00	30		
LB 2518T471□	470		3.5	10	25		
LB 2518T681□	680		3	17	20		
LB 2518T102□	1000		2.4	24	15		
LB 2518T102□	1000		2.4	24	15		0.252

□Please specify the Inductance tolerance code(K or M)

Ordering code	Inductance [ $\mu$ H]	Inductance Tolerance	Self-resonant frequency [MHz]min.	DC Resistance [ $\Omega$ ] ( $\pm 30\%$ )	Rated current [mA]max.	Measuring frequency [MHz]
LB C2518T1R0M	1.0	$\pm 20\%$	100	0.08	775	7.96
LB C2518T1R0MR	1.0		100	0.065	890	
LB C2518T1R5M	1.5		80	0.11	730	
LB C2518T2R2M	2.2		68	0.13	630	
LB C2518T3R3M	3.3		54	0.16	560	
LB C2518T4R7M	4.7		41	0.2	510	
LB C2518T6R8M	6.8	38	0.3	420	2.52	
LB C2518T100□	10	30	0.36	375		
LB C2518T150□	15	23	0.65	285		
LB C2518T220□	22	19	0.77	250		
LB C2518T330□	33	15	1.5	185		
LB C2518T470□	47	12	1.9	165		
LB C2518T680□	68	9.5	2.8	140		
LB C2518T101□	100	9	3.7	125		
LB C2518T151□	150	$\pm 10\%$ $\pm 20\%$	7	6.1	95	0.796
LB C2518T221□	220		5.5	8.4	80	
LB C2518T331□	330		4.5	12.3	65	
LB C2518T471□	470		3.5	22	50	
LB C2518T681□	680		3	28	45	

□Please specify the Inductance tolerance code(K or M)

Ordering code	Inductance [ $\mu$ H]	Inductance Tolerance	Self-resonant frequency [MHz]min.	DC Resistance [ $\Omega$ ] ( $\pm 30\%$ )	Rated current [mA]max.	Measuring frequency [MHz]
LB R2518T1R0M	1.0	$\pm 20\%$	100	0.045	960	7.96
LB R2518T2R2M	2.2		68	0.07	480	
LB R2518T4R7M	4.7		45	0.1	345	
LB R2518T100□	10	$\pm 10\%$ $\pm 20\%$	30	0.19	235	2.52
LB R2518T220□	22		19	0.44	175	
LB R2518T470□	47		11	0.84	120	
LB R2518T101□	100		9	1.89	80	
LB R2518T101□	100		9	1.89	80	

□Please specify the Inductance tolerance code(K or M)

\* This catalog contains the typical specification only due to the limitation of space. When you consider the purchase of our products, please check our specification. For details of each product (characteristics graph, reliability information, precautions for use, and so on), see our Web site (<http://www.ty-top.com/>) or CD catalogs.

■ PART NUMBERS

● 3218(1297) TYPE

Ordering code	Inductance [ $\mu$ H]	Inductance Tolerance	Self-resonant frequency [MHz] min.	DC Resistance [ $\Omega$ ] ( $\pm 30\%$ )	Rated current [mA] max.	Measuring frequency [MHz]
LB 3218T1R0M	1.0	$\pm 20\%$	100	0.06	1075	7.96
LB 3218T1R5M	1.5		80	0.07	860	
LB 3218T2R2M	2.2		68	0.09	775	
LB 3218T3R3M	3.3		54	0.11	560	
LB 3218T4R7M	4.7		41	0.13	550	
LB 3218T6R8M	6.8		40	0.17	380	
LB 3218T100□	10	$\pm 10\%$ $\pm 20\%$	30	0.25	340	2.52
LB 3218T150□	15		25	0.32	300	
LB 3218T220□	22		19	0.49	255	
LB 3218T330□	33		15	0.75	215	
LB 3218T470□	47		12	0.92	205	
LB 3218T680□	68		11	1.49	145	
LB 3218T101□	100		8	2.40	140	0.796
LB 3218T151□	150		7	3.20	105	
LB 3218T221□	220		5	5.40	80	
LB 3218T331□	330		4	7.00	65	
LB 3218T471□	470		3.5	14.0	54	
LB 3218T681□	680		3	17.0	45	
LB 3218T102□	1000		2.4	27.0	39	

□ Please specify the Inductance tolerance code (K or M)

● 3225(1210) TYPE

Ordering code	Inductance [ $\mu$ H]	Inductance Tolerance	Self-resonant frequency [MHz] min.	DC Resistance [ $\Omega$ ] ( $\pm 30\%$ )	Rated current [mA] max.	Measuring frequency [MHz]
LB C3225T1R0MR	1.0	$\pm 20\%$	250	0.055	1100	0.1
LB C3225T1R5MR	1.5		220	0.060	1000	
LB C3225T2R2MR	2.2		190	0.080	930	
LB C3225T3R3MR	3.3		160	0.095	820	
LB C3225T4R7MR	4.7		70	0.100	680	
LB C3225T6R8MR	6.8		50	0.120	620	
LB C3225T100□R	10	$\pm 10\%$ $\pm 20\%$	23	0.133	540	
LB C3225T150□R	15		20	0.195	420	
LB C3225T220□R	22		17	0.270	330	
LB C3225T330□R	33		13	0.410	300	
LB C3225T470□R	47		10	0.670	220	
LB C3225T680□R	68		8	1.00	190	
LB C3225T101□R	100		6	1.40	150	

□ Please specify the Inductance tolerance code (K or M)

\* This catalog contains the typical specification only due to the limitation of space. When you consider the purchase of our products, please check our specification. For details of each product (characteristics graph, reliability information, precautions for use, and so on), see our Web site (<http://www.ty-top.com/>) or CD catalogs.

## ELECTRICAL CHARACTERISTICS

### DC Bias characteristics (Measured by HP4285A+42841A)

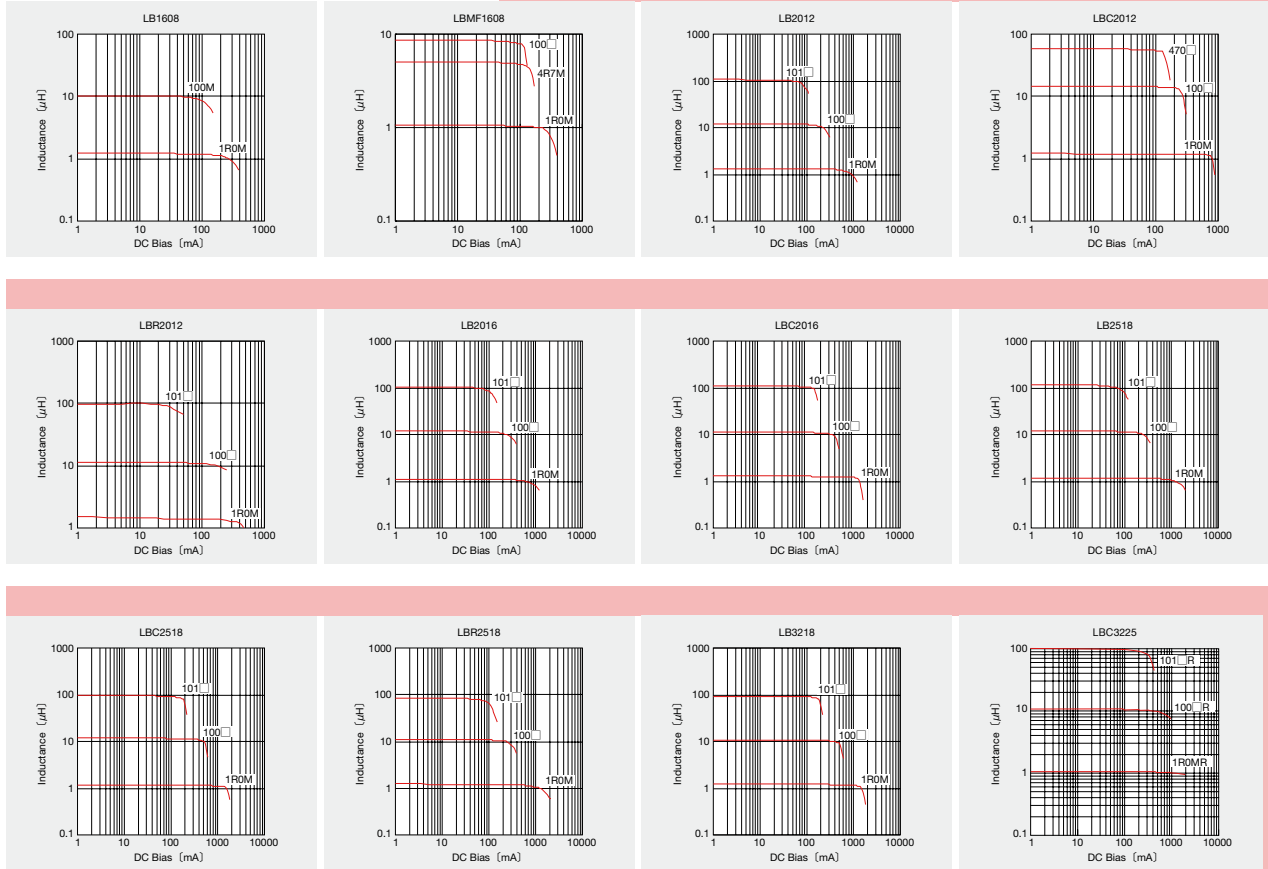

\* This catalog contains the typical specification only due to the limitation of space. When you consider the purchase of our products, please check our specification. For details of each product (characteristics graph, reliability information, precautions for use, and so on), see our Web site (<http://www.ty-top.com/>) or CD catalogs.

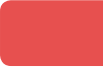

---

\* This catalog contains the typical specification only due to the limitation of space. When you consider the purchase of our products, please check our specification.  
For details of each product (characteristics graph, reliability information, precautions for use, and so on), see our Web site (<http://www.ty-top.com/>) or CD catalogs.

# WOUND CHIP POWER INDUCTORS (CB SERIES)

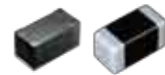

REFLOW

## FEATURES

CB-series are Wound Chip Inductors having wide line-up, which are suitable for any circuit designs.

- CBC series has large rated current. They contribute to the miniaturization of the power supply circuit.
- CBL series has low profile characteristic. They contribute to the lowering of the equipments.
- CBMF series has a low loss characteristic.

## APPLICATIONS

- They are suitable for an anti-noise measure on the power supply circuit of DSC, DVC, HDD, LCD-TV, mobile phones, PC, game equipments, various communication equipments and etc..

## OPERATING TEMP.

- -40 ~ 105°C (Including-self-generated heat)

## ORDERING CODE

C B △ 2 0 1 2 T 1 0 0 △ △ △ △ △

**1 Type**

CB	Wound chip power inductor
----	---------------------------

**2 Characteristic Spec**

△	Standard
C	High current
L	Low profile
MF	Low loss

**3 External Dimensions (mm)**

1608 (0603)	1.6×0.8
2012 (0805)	2.0×1.25
2016 (0806)	2.0×1.6
2518 (1007)	2.5×1.8
3225 (1210)	3.2×2.5

**4 Packaging**

T	Tape & Reel
---	-------------

**5 Nominal Inductance [μH]**

example	
1R0	1
100	10
101	100

※R=decimal point

**6 Inductance Tolerances (%)**

K	±10
M	±20

**7 Special code**

△	Standard products
R	Low Rdc type

**8 Internal code**

△△△	Standard Products
-----	-------------------

△=Blank space

## EXTERNAL DIMENSIONS/STANDARD QUANTITY

Type	L	W	T	e	Standard Quantity [pcs]	
					Paper Tape	Embossed Tape
CBMF1608	1.6±0.2 (0.063±0.008)	0.8±0.2 (0.031±0.008)	0.8±0.2 (0.031±0.008)	0.45±0.15 (0.016±0.006)	—	3000
CBL2012	2.0±0.2 (0.079±0.008)	1.25±0.2 (0.049±0.008)	0.9±0.1 (0.035±0.004)	0.5±0.2 (0.020±0.008)	4000	—
CB2012	2.0±0.2 (0.079±0.008)	1.25±0.2 (0.049±0.008)	1.25±0.2 (0.049±0.008)	0.5±0.2 (0.020±0.008)	—	3000
CB2016	2.0±0.2 (0.079±0.008)	1.6±0.2 (0.063±0.008)	1.6±0.2 (0.063±0.008)	0.5±0.2 (0.020±0.008)	—	2000
CB2518	2.5±0.2 (0.098±0.008)	1.8±0.2 (0.071±0.008)	1.8±0.2 (0.071±0.008)	0.5±0.2 (0.020±0.008)	—	2000
CBC3225	3.2±0.2 (0.126±0.008)	2.5±0.2 (0.098±0.008)	2.5±0.2 (0.098±0.008)	0.6±0.3 (0.024±0.012)	—	1000

Unit : mm

TYPE	A	B	C
MF1608	0.55	0.7	1.0
2012	0.60	1.0	1.45
2016	0.60	1.0	1.8
2518	0.60	1.5	2.0
3218	0.85	1.7	2.0
3225	0.85	1.7	2.7

Recommended Land Patterns

Surface Mounting

- Mounting and soldering conditions should be checked beforehand.
- Applicable soldering process to those products is reflow soldering only.
- Recommended Land Patterns

## AVAILABLE INDUCTANCE RANGE

Range	Type	CBMF1608		CBL2012		CB2012		CBC2012		CB2016		CBC2016		CB2518		CBC2518		CBC3225	
		I <sub>max</sub> [mA]	Rdc±30% [Ω]	I <sub>max</sub> [mA]	Rdc±30% [Ω]	I <sub>max</sub> [mA]	Rdc±30% [Ω]	I <sub>max</sub> [mA]	Rdc±30% [Ω]	I <sub>max</sub> [mA]	Rdc±30% [Ω]	I <sub>max</sub> [mA]	Rdc±30% [Ω]	I <sub>max</sub> [mA]	Rdc±30% [Ω]	I <sub>max</sub> [mA]	Rdc±30% [Ω]	I <sub>max</sub> [mA]	Rdc±30% [Ω]
Inductance [μH]	1	350	1μH 0.09	620	1μH 0.15	500	1μH 0.15	700	1μH 0.19	600	1μH 0.09	1100	1μH 0.1	1200	1μH 0.06	1000	1μH 0.08	1440	1μH 0.055
	22	230	0.17	530	0.33	410	0.23	530	0.33	510	0.13	750	0.2	510	0.09	890	0.13	1130	0.08
	10	115	0.36	440	1.0	200	0.5	240	1.2	250	0.5	380	0.82	250	2.40	480	0.36	900	0.133
	47	50	2.5	100	4.2	90	3.7	120	5.8	110	2.4	150	4.3	110	0.95	240	1.90	390	0.67
	100	—	—	—	—	—	—	—	—	—	—	—	—	—	—	—	—	—	—
1000	—	—	—	—	—	—	—	—	—	—	—	—	—	—	—	—	—	—	—

\* This catalog contains the typical specification only due to the limitation of space. When you consider the purchase of our products, please check our specification. For details of each product (characteristics graph, reliability information, precautions for use, and so on), see our Web site (<http://www.ty-top.com/>) or CD catalogs.



**PART NUMBERS**

● 1608 (0603) TYPE

Ordering code	EHS (Environmental Hazardous Substances)	Inductance [μH]	Inductance Tolerance	Self-resonant frequency [MHz] min.	Resistance DC [Ω] (±30%)	Rated current [mA]		Measuring frequency [MHz]
						Saturation current Idc1	Temperature rise current Idc2	
CBMF1608T1R0M	RoHS	1.0	±20%	100	0.09	290	770	7.96
CBMF1608T2R2M	RoHS	2.2		80	0.17	190	560	
CBMF1608T3R3M	RoHS	3.3		60	0.22	170	500	
CBMF1608T4R7M	RoHS	4.7		45	0.24	145	470	
CBMF1608T100□	RoHS	10	±10% ±20%	32	0.36	115	380	2.52
CBMF1608T220□	RoHS	22		16	1.00	70	230	
CBMF1608T470□	RoHS	47		11	2.50	50	140	

□ Please specify the Inductance tolerance code (K or M)

● 2012(0805)TYPE

Ordering code	EHS (Environmental Hazardous Substances)	Inductance [μH]	Inductance Tolerance	Self-resonant frequency [MHz] min.	Resistance DC [Ω] (±30%)	Rated current [mA]		Measuring frequency [MHz]
						Saturation current Idc1	Temperature rise current Idc2	
CB 2012T1R0M	RoHS	1.0	±20%	100	0.15	500	900	7.96
CB 2012T2R2M	RoHS	2.2		80	0.23	410	770	
CB 2012T3R3M	RoHS	3.3		55	0.30	330	650	
CB 2012T4R7M	RoHS	4.7		45	0.40	300	580	
CB 2012T6R8M	RoHS	6.8	±10% ±20%	35	0.47	250	540	2.52
CB 2012T100□	RoHS	10		32	0.7	190	440	
CB 2012T100□R	RoHS	10		32	0.5	200	520	
CB 2012T150□	RoHS	15		28	1.3	170	320	
CB 2012T220□	RoHS	22		16	1.7	135	280	
CB 2012T470□	RoHS	47		11	3.7	90	190	
CB 2012T680□	RoHS	68		10	6.0	70	140	
CB 2012T101□	RoHS	100		8	7.0	60	130	

□ Please specify the Inductance tolerance code (K or M)

Ordering code	EHS (Environmental Hazardous Substances)	Inductance [μH]	Inductance Tolerance	Self-resonant frequency [MHz] min.	Resistance DC [Ω] (±30%)	Rated current [mA]		Measuring frequency [MHz]
						Saturation current Idc1	Temperature rise current Idc2	
CB C2012T1R0M	RoHS	1.0	±20%	100	0.19	700	840	7.96
CB C2012T2R2M	RoHS	2.2		70	0.33	530	640	
CB C2012T4R7M	RoHS	4.7		45	0.5	360	520	
CB C2012T100□	RoHS	10	±10% ±20%	40	1.2	240	340	2.52
CB C2012T220□	RoHS	22		16	3.7	170	190	
CB C2012T470□	RoHS	47		11	5.8	120	150	

□ Please specify the Inductance tolerance code (K or M)

Ordering code	EHS (Environmental Hazardous Substances)	Inductance [μH]	Inductance Tolerance	Self-resonant frequency [MHz] min.	Resistance DC [Ω] (±30%)	Rated current [mA]		Measuring frequency [MHz]
						Saturation current Idc1	Temperature rise current Idc2	
CB L2012T1R0M	RoHS	1.0	±20%	100	0.15	620	950	0.1
CB L2012T2R2M	RoHS	2.2		80	0.39	440	590	
CB L2012T4R7M	RoHS	4.7		45	0.66	275	490	
CB L2012T100M	RoHS	10		32	1	205	370	
CB L2012T220M	RoHS	22		23	2.1	150	250	
CB L2012T470M	RoHS	47		11	4.2	100	140	

□ Please specify the Inductance tolerance code (K or M)

● 2016 (0806) TYPE

Ordering code	EHS (Environmental Hazardous Substances)	Inductance [μH]	Inductance Tolerance	Self-resonant frequency [MHz] min.	Resistance DC [Ω] (±30%)	Rated current [mA]		Measuring frequency [MHz]
						Saturation current Idc1	Temperature rise current Idc2	
CB 2016T1R0M	RoHS	1.0	±20%	100	0.09	600	1100	7.96
CB 2016T1R5M	RoHS	1.5		80	0.11	550	1000	
CB 2016T2R2M	RoHS	2.2		70	0.13	510	1000	
CB 2016T3R3M	RoHS	3.3		55	0.20	400	800	
CB 2016T4R7M	RoHS	4.7		45	0.25	340	740	
CB 2016T6R8M	RoHS	6.8		38	0.35	300	600	
CB 2016T100□	RoHS	10	±10% ±20%	32	0.50	250	520	2.52
CB 2016T150□	RoHS	15		28	0.70	210	440	
CB 2016T220□	RoHS	22		16	1.0	165	370	
CB 2016T330□	RoHS	33		14	1.7	130	270	
CB 2016T470□	RoHS	47		11	2.4	110	240	
CB 2016T680□	RoHS	68		10	3.0	90	210	
CB 2016T101□	RoHS	100	8	4.5	70	170	0.796	

□ Please specify the Inductance tolerance code (K or M)

※) The saturation current value (Idc1) is the DC current value having inductance decrease down to 30%. (at 20°C)  
 ※) The temperature rise current value (Idc2) is the DC current value having temperature increase up to 40°C. (at 20°C)

\* This catalog contains the typical specification only due to the limitation of space. When you consider the purchase of our products, please check our specification.  
 For details of each product (characteristics graph, reliability information, precautions for use, and so on), see our Web site (<http://www.ty-top.com/>) or CD catalogs.

**PART NUMBERS**

Ordering code	EHS (Environmental Hazardous Substances)	Inductance [μH]	Inductance Tolerance	Self-resonant frequency [MHz] min.	Resistance DC [Ω] (±30%)	Rated current [mA]		Measuring frequency [MHz]		
						Saturation current I <sub>dc1</sub>	Temperature rise current I <sub>dc2</sub>			
CB C2016T1R0M	RoHS	1.0	±20%	100	0.1	1100	1100	7.96		
CB C2016T1R5M	RoHS	1.5		80	0.15	1000	1000			
CB C2016T2R2M	RoHS	2.2		70	0.2	750	720			
CB C2016T3R3M	RoHS	3.3		55	0.27	600	610			
CB C2016T4R7M	RoHS	4.7		45	0.37	550	530			
CB C2016T6R8M	RoHS	6.8		38	0.59	450	450			
CB C2016T100□	RoHS	10	±10% ±20%	32	0.82	380	350	2.52		
CB C2016T150□	RoHS	15		28	1.2	300	300			
CB C2016T220□	RoHS	22		16	1.8	250	240			
CB C2016T330□	RoHS	33		14	2.8	220	220			
CB C2016T470□	RoHS	47		11	4.3	150	150			
CB C2016T680□	RoHS	68		10	7	130	130			
CB C2016T101□	RoHS	100		8	8	110	110			
										0.796

□ Please specify the Inductance tolerance code (Kor M)

**2518(1007) TYPE**

Ordering code	EHS (Environmental Hazardous Substances)	Inductance [μH]	Inductance Tolerance	Self-resonant frequency [MHz] min.	Resistance DC [Ω] (±30%)	Rated current [mA]		Measuring frequency [MHz]	
						Saturation current I <sub>dc1</sub>	Temperature rise current I <sub>dc2</sub>		
CB 2518T1R0M	RoHS	1.0	±20%	100	0.06	1200	1500	7.96	
CB 2518T1R5M	RoHS	1.5		80	0.07	650	1400		
CB 2518T2R2M	RoHS	2.2		68	0.09	510	1300		
CB 2518T3R3M	RoHS	3.3		54	0.11	440	1200		
CB 2518T4R7MR	RoHS	4.7		46	0.10	310	1200		
CB 2518T4R7M	RoHS	4.7		46	0.13	340	1100		
CB 2518T6R8M	RoHS	6.8	38	0.15	270	930	2.52		
CB 2518T100□	RoHS	10	30	0.25	250	820			
CB 2518T150□	RoHS	15	23	0.32	180	650			
CB 2518T220□	RoHS	22	19	0.50	165	580			
CB 2518T330□	RoHS	33	15	0.70	130	460			
CB 2518T470□	RoHS	47	12	0.95	110	420			
CB 2518T680□	RoHS	68	9.5	1.50	70	310			
CB 2518T101□	RoHS	100	9	2.10	60	260			
CB 2518T151□	RoHS	150	7	3.20	55	210			
CB 2518T221□	RoHS	220	5.5	4.50	50	180			
CB 2518T331□	RoHS	330	4.5	7.00	40	140	0.796		
CB 2518T471□	RoHS	470	3.5	10	35	120			
CB 2518T681□	RoHS	680	3	17	30	90			
CB 2518T102□	RoHS	1000	2.4	24	25	75			
									0.252

□ Please specify the Inductance tolerance code (Kor M)

Ordering code	EHS (Environmental Hazardous Substances)	Inductance [μH]	Inductance Tolerance	Self-resonant frequency [MHz] min.	Resistance DC [Ω] (±30%)	Rated current [mA]		Measuring frequency [MHz]
						Saturation current I <sub>dc1</sub>	Temperature rise current I <sub>dc2</sub>	
CB C2518T1R0M	RoHS	1.0	±20%	100	0.08	1000	1200	7.96
CB C2518T1R5M	RoHS	1.5		80	0.11	950	1190	
CB C2518T2R2M	RoHS	2.2		68	0.13	890	1100	
CB C2518T3R3M	RoHS	3.3		54	0.16	730	1020	
CB C2518T4R7M	RoHS	4.7		41	0.2	680	920	
CB C2518T6R8M	RoHS	6.8		38	0.3	550	740	
CB C2518T100□	RoHS	10	30	0.36	480	680	2.52	
CB C2518T150□	RoHS	15	23	0.65	350	500		
CB C2518T220□	RoHS	22	19	0.77	320	460		
CB C2518T330□	RoHS	33	15	1.5	270	320		
CB C2518T470□	RoHS	47	12	1.9	240	290		
CB C2518T680□	RoHS	68	9.5	2.8	200	200		
CB C2518T101□	RoHS	100	9	3.7	160	170		
CB C2518T151□	RoHS	150	7	6.1	140	130		
CB C2518T221□	RoHS	220	5.5	8.4	115	110		
CB C2518T331□	RoHS	330	4.5	12.3	100	90		0.796
CB C2518T471□	RoHS	470	3.5	22	80	70		
CB C2518T681□	RoHS	680	3	28	65	60		

□ Please specify the Inductance tolerance code (Kor M)

※) The saturation current value (I<sub>dc1</sub>) is the DC current value having inductance decrease down to 30%. (at 20°C)  
 ※) The temperature rise current value (I<sub>dc2</sub>) is the DC current value having temperature increase up to 40°C. (at 20°C)

\* This catalog contains the typical specification only due to the limitation of space. When you consider the purchase of our products, please check our specification. For details of each product (characteristics graph, reliability information, precautions for use, and so on), see our Web site (<http://www.ty-top.com/>) or CD catalogs.

## PART NUMBERS

### 3225 (1210) TYPE

Ordering code	EHS (Environmental Hazardous Substances)	Inductance [ $\mu$ H]	Inductance Tolerance	Self-resonant frequency [MHz] min.	Resistance DC [ $\Omega$ ] ( $\pm 30\%$ )	Rated current [mA]		Measuring frequency [MHz]
						Saturation current I <sub>dc1</sub>	Temperature rise current I <sub>dc2</sub>	
CB C3225T1R0MR	RoHS	1.0	$\pm 20\%$	250	0.055	2000	1440	0.1
CB C3225T1R5MR	RoHS	1.5		220	0.06	2000	1310	
CB C3225T2R2MR	RoHS	2.2		190	0.08	2000	1130	
CB C3225T3R3MR	RoHS	3.3		160	0.095	2000	1040	
CB C3225T4R7MR	RoHS	4.7		70	0.1	1250	1010	
CB C3225T6R8MR	RoHS	6.8		50	0.12	930	940	
CB C3225T100□R	RoHS	10	$\pm 10\%$ $\pm 20\%$	23	0.133	900	900	
CB C3225T150□R	RoHS	15		20	0.195	730	850	
CB C3225T220□R	RoHS	22		17	0.27	620	780	
CB C3225T330□R	RoHS	33		13	0.41	500	570	
CB C3225T470□R	RoHS	47		10	0.67	390	480	
CB C3225T680□R	RoHS	68		8	1	320	410	
CB C3225T101□R	RoHS	100		6	1.4	270	340	

□ Please specify the Inductance tolerance code (K or M)

※ The saturation current value (I<sub>dc1</sub>) is the DC current value having inductance decrease down to 30%. (at 20°C)

※ The temperature rise current value (I<sub>dc2</sub>) is the DC current value having temperature increase up to 40°C. (at 20°C)

## ELECTRICAL CHARACTERISTICS

### DC Bias characteristics Measured by HP4285A+42841A

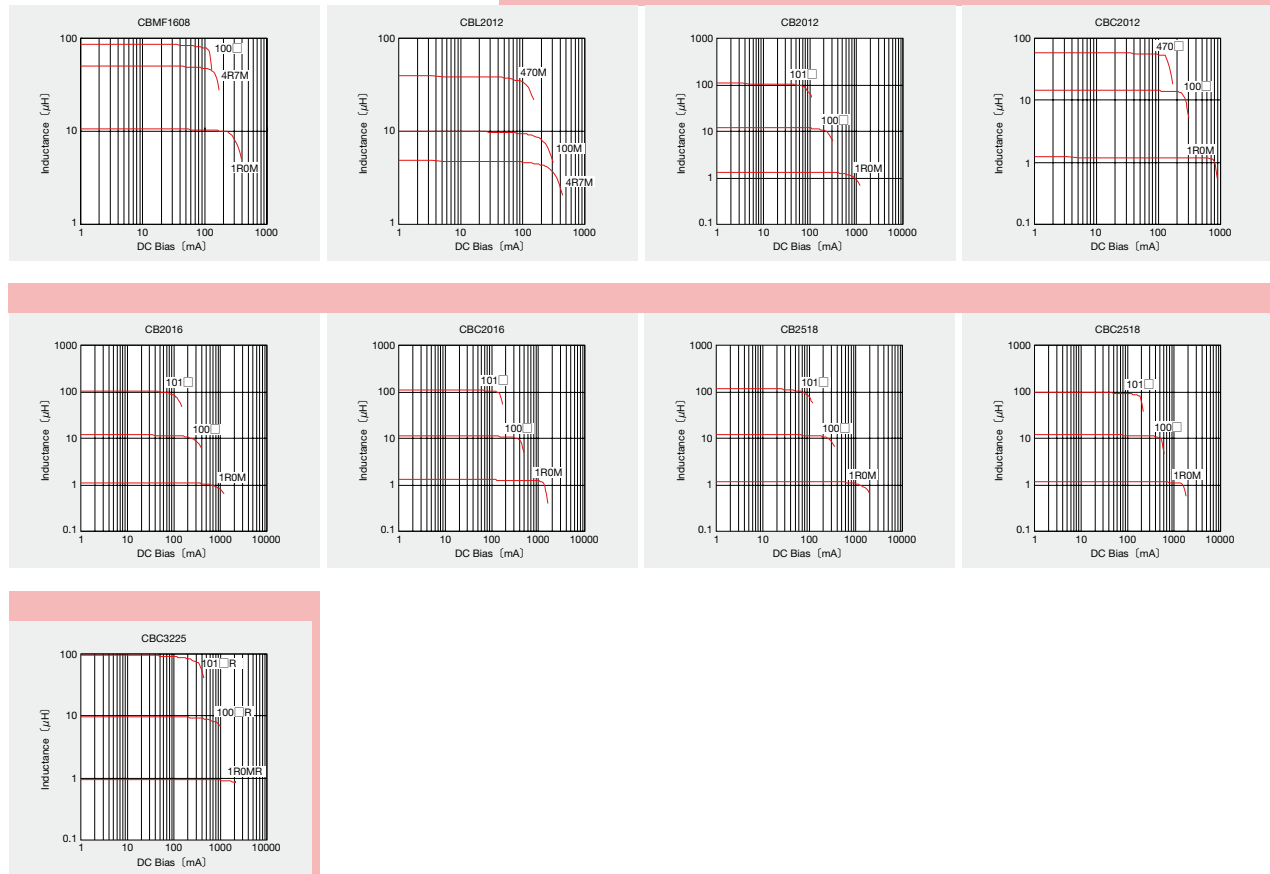

\* This catalog contains the typical specification only due to the limitation of space. When you consider the purchase of our products, please check our specification.  
For details of each product (characteristics graph, reliability information, precautions for use, and so on), see our Web site (<http://www.ty-top.com/>) or CD catalogs.

# WOUND CHIP INDUCTORS FOR SIGNAL LINE (LB/LE SERIES M TYPE)



LB: REFLOW LE: WAVE REFLOW

## FEATURES

- **LBM2016 Series**  
LBM2016-Series which are the wound chip inductors for signal line propose Down sizing with High Q and narrow tolerance.
- **LEM2520 Series**  
A high-quality inductor that is simple to mass-produce and conforms to the same production process and basic construction as an axial lead type inductor.

## APPLICATIONS

- LBM series are suitable for the analog signal line of DSC, DVC, HDD, LCD-TV, game equipments, STB, various audio-visual equipments, various communication equipments and etc..

## OPERATING TEMP.

- **LBM2016 Series**  
- 40 ~ 105°C (Including-self-generated heat)

## ORDERING CODE

L B M 2 0 1 6 T 1 0 0 J  $\triangle$

① Type		② External Dimensions (mm)		③ Packaging		④ Nominal Inductance ( $\mu$ H)		⑤ Inductance Tolerances		⑥ Internal code	
LBM	Wound chip inductor for signal line	2016	2.0×1.6	T	Tape & Reel	example		J	$\pm 5\%$	$\triangle$	Standard Products
LEM	Wound chip inductor for signal line	2520	2.5×2.0			R12	0.12	K	$\pm 10\%$		$\triangle$ =Blank space

※R=decimal point

## EXTERNAL DIMENSIONS/STANDARD QUANTITY

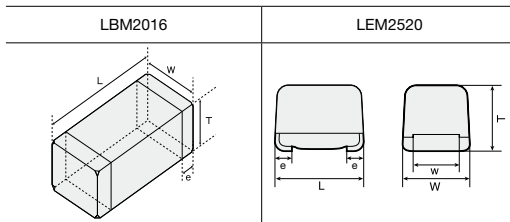

Type	L	W	T	e	W	Standard Quantity [pcs]	
						Paper Tape	Embossed Tape
LBM2016	2.0±0.2 (0.08±0.008)	1.6±0.2 (0.063±0.008)	1.6±0.2 (0.063±0.008)	0.5±0.2 (0.02±0.008)		-	2000
LEM2520	2.5±0.2 (0.098±0.008)	2.0±0.2 (0.079±0.008)	1.8±0.2 (0.071±0.008)	0.45 (0.018)	1.4±0.1 (0.055±0.004)		2000

Unit : mm (inch)

### Recommended Land Patterns

#### Surface Mounting

- Mounting and soldering conditions should be checked beforehand.
- Applicable soldering process to those products is reflow soldering only. (LB only)
- Recommended Land Patterns

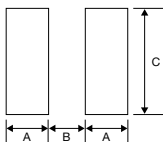

TYPE	Unit : mm		
	A	B	C
LBM2016	0.6	1.0	1.8
LEM2520	0.9	1.5	1.5

## AVAILABLE INDUCTANCE RANGE

Range	Type		Type	
	LBM2016	LEM2520	LBM2016	LEM2520
Ordinary type Inductance [ $\mu$ H]	0.12	$I_{dc}$ [mA] 610 $R_{dc} \pm 30\%$ [ $\Omega$ ] 0.13	0.12	$I_{dc}$ [mA] 520 $R_{dc}$ max [ $\Omega$ ] 0.37
	1.0	385 0.38	1.0	245 1.10
	10	215 1.20	10	155 3.50
	100	80 8.00	100	60 21.00

100  $\mu$ H      100  $\mu$ H

\* This catalog contains the typical specification only due to the limitation of space. When you consider the purchase of our products, please check our specification. For details of each product (characteristics graph, reliability information, precautions for use, and so on), see our Web site (<http://www.ty-top.com/>) or CD catalogs.

**PART NUMBERS**

**LBM2016 TYPE**

Ordering code	EHS (Environmental Hazardous Substances)	Inductance (μH)	Inductance Tolerance	Q (min.)	Self-resonant frequency [MHz] min.	Resistance DC (Ω) (±30%)	Rated current [mA] (max.)	Measuring frequency [MHz]
LB M2016TR12J	RoHS	0.12	±5%	30	600	0.13	610	25.2
LB M2016TR15J	RoHS	0.15			550	0.15	570	
LB M2016TR18J	RoHS	0.18			500	0.15	560	
LB M2016TR22J	RoHS	0.22			450	0.20	520	
LB M2016TR27J	RoHS	0.27			425	0.21	510	
LB M2016TR33J	RoHS	0.33			400	0.21	490	
LB M2016TR39J	RoHS	0.39			375	0.26	440	
LB M2016TR47J	RoHS	0.47			350	0.26	430	
LB M2016TR56J	RoHS	0.56			300	0.29	410	
LB M2016TR68J	RoHS	0.68			270	0.32	400	
LB M2016TR82J	RoHS	0.82			250	0.34	390	
LB M2016T1R0J	RoHS	1.0			220	0.38	385	
LB M2016T1R2J	RoHS	1.2			180	0.41	370	
LB M2016T1R5J	RoHS	1.5			135	0.47	350	
LB M2016T1R8J	RoHS	1.8			100	0.48	345	
LB M2016T2R2J	RoHS	2.2		75	0.54	340		
LB M2016T2R7J	RoHS	2.7		55	0.59	310		
LB M2016T3R3J	RoHS	3.3		48	0.68	290		
LB M2016T3R9J	RoHS	3.9		43	0.74	275		
LB M2016T4R7J	RoHS	4.7		40	0.78	270		
LB M2016T5R6J	RoHS	5.6		36	0.88	255		
LB M2016T6R8J	RoHS	6.8		33	0.97	240		
LB M2016T8R2J	RoHS	8.2		30	1.10	225		
LB M2016T100J	RoHS	10		27	1.20	215		
LB M2016T120J	RoHS	12		23	1.4	200		
LB M2016T150J	RoHS	15		20	1.5	190		
LB M2016T180J	RoHS	18		18	2.5	150		
LB M2016T220J	RoHS	22		17	2.8	140		
LB M2016T270J	RoHS	27		16	3.2	130		
LB M2016T330J	RoHS	33		15	3.6	125		
LB M2016T390J	RoHS	39	14	3.9	120			
LB M2016T470J	RoHS	47	13	4.1	115			
LB M2016T560J	RoHS	56	12	5.9	95			
LB M2016T680J	RoHS	68	11	7.0	90			
LB M2016T820J	RoHS	82	10	7.7	85			
LB M2016T101J	RoHS	100	9.0	8.0	80	0.796		

**LEM2520 TYPE**

Ordering code	EHS (Environmental Hazardous Substances)	Inductance (μH)	Inductance Tolerance	Q (min.)	Self-resonant frequency [MHz] min.	Resistance DC (Ω) (max.)	Rated current [mA] (max.)	Measuring frequency [MHz]
LEM 2520 TR12K	RoHS	0.12	±10%	30	600	0.37	520	25.2
LEM 2520 TR15K	RoHS	0.15			550	0.42	480	
LEM 2520 TR18K	RoHS	0.18			500	0.46	460	
LEM 2520 TR22K	RoHS	0.22			450	0.52	430	
LEM 2520 TR27K	RoHS	0.27			425	0.56	420	
LEM 2520 TR33K	RoHS	0.33			400	0.60	400	
LEM 2520 TR39K	RoHS	0.39			375	0.65	375	
LEM 2520 TR47K	RoHS	0.47			350	0.68	350	
LEM 2520 TR56K	RoHS	0.56			300	0.75	325	
LEM 2520 TR68K	RoHS	0.68			270	0.85	300	
LEM 2520 TR82K	RoHS	0.82			250	1.00	260	
LEM 2520 T1R0J	RoHS	1.0			220	1.10	245	
LEM 2520 T1R2J	RoHS	1.2			180	1.20	230	
LEM 2520 T1R5J	RoHS	1.5			135	1.30	220	
LEM 2520 T1R8J	RoHS	1.8			100	1.45	210	
LEM 2520 T2R2J	RoHS	2.2	75	1.55	200			
LEM 2520 T2R7J	RoHS	2.7	55	1.70	195			
LEM 2520 T3R3J	RoHS	3.3	48	1.90	185			
LEM 2520 T3R9J	RoHS	3.9	43	2.10	180			
LEM 2520 T4R7J	RoHS	4.7	40	2.30	175			
LEM 2520 T5R6J	RoHS	5.6	36	2.50	170			
LEM 2520 T6R8J	RoHS	6.8	33	2.70	165			
LEM 2520 T8R2J	RoHS	8.2	30	3.05	160			
LEM 2520 T100J	RoHS	10	27	3.50	155			
LEM 2520 T120J	RoHS	12	23	3.80	150			
LEM 2520 T150J	RoHS	15	20	4.40	140			
LEM 2520 T180J	RoHS	18	18	4.80	130			
LEM 2520 T220J	RoHS	22	17	5.50	125			
LEM 2520 T270J	RoHS	27	16	6.30	115			
LEM 2520 T330J	RoHS	33	15	7.10	110			
LEM 2520 T390J	RoHS	39	14	9.50	90			
LEM 2520 T470J	RoHS	47	13	11.10	80			
LEM 2520 T560J	RoHS	56	12	12.10	75			
LEM 2520 T680J	RoHS	68	11	16.60	70			
LEM 2520 T820J	RoHS	82	10	19.00	65			
LEM 2520 T101J	RoHS	100	9	21.00	60	0.796		

\* This catalog contains the typical specification only due to the limitation of space. When you consider the purchase of our products, please check our specification. For details of each product (characteristics graph, reliability information, precautions for use, and so on), see our Web site (<http://www.ty-top.com/>) or CD catalogs.

● LBM2016

■ Q-vs-Frequency characteristics

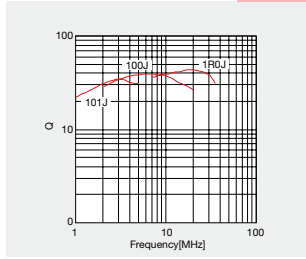

■ Impedance-vs-Frequency characteristics

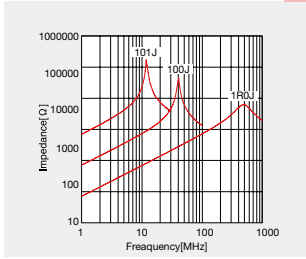

■ Inductance-vs-Frequency characteristics

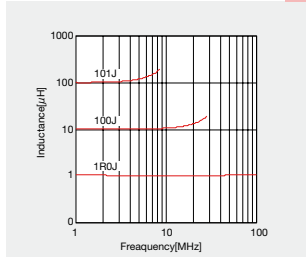

● LEM2520

■ Q-vs-Frequency characteristics

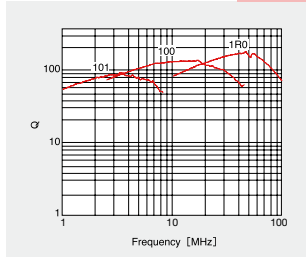

■ Impedance-vs-Frequency characteristics

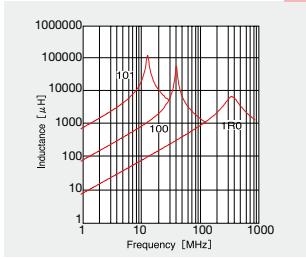

■ Inductance-vs-Frequency characteristics

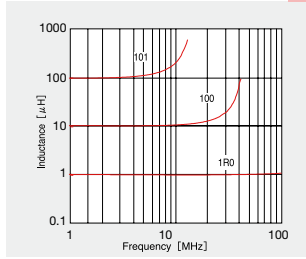

\* This catalog contains the typical specification only due to the limitation of space. When you consider the purchase of our products, please check our specification. For details of each product (characteristics graph, reliability information, precautions for use, and so on), see our Web site (<http://www.ty-top.com/>) or CD catalogs.

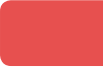

---

\* This catalog contains the typical specification only due to the limitation of space. When you consider the purchase of our products, please check our specification.  
For details of each product (characteristics graph, reliability information, precautions for use, and so on), see our Web site (<http://www.ty-top.com/>) or CD catalogs.

# PACKAGING

## ① Minimum Quantity

Type	Standard Quantity [pcs]	
	Papar Tape	Embossed Tape
LBC3225/CBC3225	—	1000
LB3218	—	2000
LBR2518/LBC2518/LB251/CB2518/CBC2518/LEM2520	—	2000
LBM2016/LBC2016/LB2016/CB2016/CBC2016	—	2000
LB2012/LBC2012/LBR202/CB2012/CBC2012	—	3000
CBL2012	4000	—
LB1608	4000	—
LBMF1608/CBMF1608	—	3000

## ② Tape material

- Embossed tape

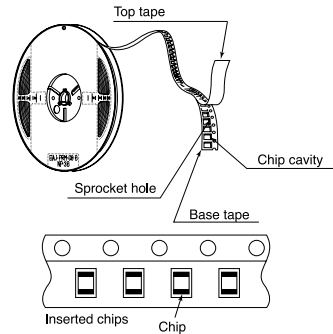

## ③ Taping Dimensions

- Embossed Tape (0.315 inches wide)
- Card board carrier tape (0.315 inches wide)

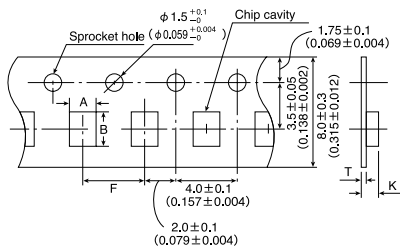

Type	Chip cavity		Insertion pitch F	Tape thickness	
	A	B		T	K
LBM 2016	$1.75 \pm 0.1$ (0.069 ± 0.004)	$2.1 \pm 0.1$ (0.083 ± 0.004)	$4.0 \pm 0.1$ (0.157 ± 0.004)	$0.3 \pm 0.05$ (0.012 ± 0.002)	1.9max. (0.074)
LEM 2520	$2.3 \pm 0.1$ (0.091 ± 0.004)	$2.7 \pm 0.1$ (0.106 ± 0.004)	$4.0 \pm 0.1$ (0.157 ± 0.004)	$0.3 \pm 0.05$ (0.012 ± 0.002)	$2.1 \pm 0.1$ (0.083 ± 0.004)
LBC3225/ CBC3225	$2.8 \pm 0.1$ (0.110 ± 0.004)	$3.5 \pm 0.1$ (0.138 ± 0.004)	$4.0 \pm 0.1$ (0.157 ± 0.004)	$0.3 \pm 0.05$ (0.012 ± 0.002)	4.0max. (0.157)
LB3218	$2.1 \pm 0.1$ (0.084 ± 0.004)	$3.5 \pm 0.1$ (0.014 ± 0.004)	$4.0 \pm 0.1$ (0.157 ± 0.004)	$0.3 \pm 0.05$ (0.012 ± 0.002)	2.2max. (0.086)
LB2518 / CB2518 LBC2518 / CBC2518 LBR2518	$2.15 \pm 0.1$ (0.085 ± 0.004)	$2.7 \pm 0.1$ (0.107 ± 0.004)	$4.0 \pm 0.1$ (0.157 ± 0.004)	$0.3 \pm 0.05$ (0.012 ± 0.002)	2.2max. (0.086)
LB2016 / CB2016 LBC2016 / CBC2016	$1.75 \pm 0.1$ (0.069 ± 0.004)	$2.1 \pm 0.1$ (0.083 ± 0.004)	$4.0 \pm 0.1$ (0.157 ± 0.004)	$0.3 \pm 0.05$ (0.012 ± 0.002)	1.9max. (0.074)
LB2012 / CB2012 LBC2012 / CBC2012 LBR2012	$1.45 \pm 0.1$ (0.058 ± 0.004)	$2.25 \pm 0.1$ (0.09 ± 0.004)	$4.0 \pm 0.1$ (0.157 ± 0.004)	$0.25 \pm 0.05$ (0.010 ± 0.002)	1.45max. (0.057)
CBL2012	$1.55 \pm 0.1$ (0.061 ± 0.004)	$2.3 \pm 0.1$ (0.091 ± 0.004)	$4.0 \pm 0.1$ (0.157 ± 0.004)	1.1max. (0.044)	1.1max. (0.044)
LB1608	$1.0 \pm 0.1$ (0.059 ± 0.004)	$1.8 \pm 0.1$ (0.072 ± 0.004)	$4.0 \pm 0.1$ (0.157 ± 0.004)	1.1max. (0.044)	1.1max. (0.044)
LBMF1608 / CBMF1608	$1.1 \pm 0.1$ (0.04 ± 0.004)	$1.9 \pm 0.1$ (0.076 ± 0.004)	$4.0 \pm 0.1$ (0.157 ± 0.004)	$0.25 \pm 0.05$ (0.010 ± 0.002)	1.2max. (0.047)

Unit : mm (inch)

## ④ Leader and Blank Portion

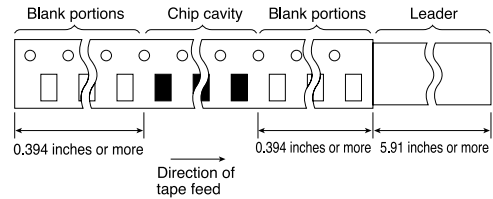

## ⑤ Reel Size

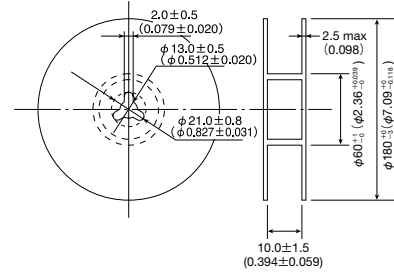

## ⑥ Top Tape Strength

The top tape requires a peel-off force 0.2 to 0.7N in the direction of the arrow as illustrated below.

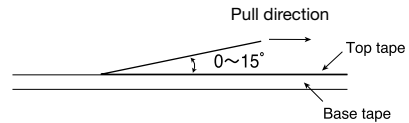

\* This catalog contains the typical specification only due to the limitation of space. When you consider the purchase of our products, please check our specification. For details of each product (characteristics graph, reliability information, precautions for use, and so on), see our Web site (<http://www.ty-top.com/>) or CD catalogs.



## RELIABILITY DATA

1. Operating temperature Range	
LB, LBC, LBR, LBMF Series	-40~+105°C (Including self-generated heat)
CB, CBC, CBL, CBMF Series	
LBM Series	
LEM Series	

2. Storage	
LB, LBC, LBR, LBMF Series	-40~+85°C
CB, CBC, CBL, CBMF Series	
LBM, LEM Series	
[Test Methods and Remarks] Please refer the term of "7. storage conditions" in precautions.	

3. Rated Current	
LB, LBC, LBR, LBMF Series	Within the specified tolerance
CB, CBC, CBL, CBMF Series	
LBM, LEM Series	
[Test Methods and Remarks] LEM Series The maximum DC value having inductance decrease within 10% and temperature increase within 20°C by the application of DC bias.	

4. Inductance	
LB, LBC, LBR, LBMF Series	Within the specified tolerance
CB, CBC, CBL, CBMF Series	
LBM, LEM Series	
[Test Methods and Remarks] LEM Series Measuring equipment : LCR Meter (HP4285A+42851A or its equivalent) Measuring frequency : Specified frequency LB · LBC · LBR · CB · CBC · CBL · LBMF · CBMF · LBM Series Measuring equipment : LCR Meter (HP4285A or its equivalent)	

5. Q	
LB, LBC, LBR, LBMF Series	Within the specified tolerance
CB, CBC, CBL, CBMF Series	
LBM, LEM Series	
[Test Methods and Remarks] LEM Series Measuring equipment : LCR Meter (HP4285A+42851A or its equivalent) Measuring frequency : Specified frequency LBM Series Measuring equipment : LCR Meter (HP4285A or its equivalent)	

6. DC Resistance	
LB, LBC, LBR, LBMF Series	Within the specified tolerance
CB, CBC, CBL, CBMF Series	
LBM, LEM Series	
[Test Methods and Remarks] Measuring equipment : DC Ohmmeter (HIOKI 3227 or its equivalent)	

7. Self-Resonant Frequency	
LB, LBC, LBR, LBMF Series	Within the specified tolerance
CB, CBC, CBL, CBMF Series	
LBM, LEM Series	
[Test Methods and Remarks] Measuring equipment : Impedance analyzer (HP4291A or its equivalent)	

8. Temperature Characteristic						
LBM2016	LEM2520					Inductance change: Within ±5%
LB1608	LB2012	LBR2012	CB2012	CBL2012	LB2016	Inductance change: Within ±20%
CB2016	LB2518	LBR2518	CB2518	LBC3225	CBC3225	
LBMF1608	CBMF1608	LBC2016	CBC2016	LBC2518	Inductance change: Within ±25%	
CBC2518	LB3218					Inductance change: Within ±35%
LBC2012	CBC2012					
[Test Methods and Remarks] Change of maximum inductance deviation in step 1-5						
LB, CB Series	Step	1	2	3	4	5
	Temperature (°C)	20	-40	20 (Reference temperature)	+85 (Maximum operating temperature)	20
LEM2520	Step	1	2	3	4	5
	Temperature (°C)	20	-25	20 (Reference temperature)	+85 (Maximum operating temperature)	20

9. Resistance to Flexure of Substrate	
LB, LBC, LBR, LBMF Series	No damage.
CB, CBC, CBL, CBMF Series	
LBM, LEM Series	
[Test Methods and Remarks] Warp : 2mm (LB · LBC · LBR · CB · CBC · CBL · LBM · LBMF · CBMF Series) 3mm (LEM2520) Test substrate: Board according to JIS C0051	

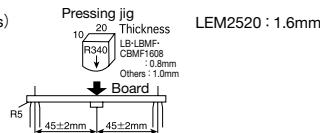

\* This catalog contains the typical specification only due to the limitation of space. When you consider the purchase of our products, please check our specification.  
For details of each product (characteristics graph, reliability information, precautions for use, and so on), see our Web site (<http://www.ty-top.com/>) or CD catalogs.

## RELIABILITY DATA

10.Body Strength	
LB, LBC, LBR, LBMF Series	No damage.
CB, CBC, CBL, CBMF Series	
LBM, LEM Series	
[Test Methods and Remarks]	
LB·LBC·LBR·CB·CBC·CBL·LBM·LEM2520	Applied force : 10N Duration : 10sec.
LB1608·LBMF1608·CBMF1608	Applied force : 5N Duration : 10sec.
11.Adhesion of terminal electrode	
LB, LBC, LBR, LBMF Series	No abnormality.
CB, CBC, CBL, CBMF Series	
LBM, LEM Series	
[Test Methods and Remarks]	
LB·LBC·LBR·CB·CBC·CBL·LBM·LBMF·CBMF·LEM2520	Applied force : 10N to X and Y directions Duration : 5 sec. Test substrate : Printed board
LB1608·CBMF1608·LBMF1608	Applied force : 5N to X and Y directions Duration : 5 sec. Test substrate : Printed board
12.Resistance to vibration	
LB, LBC, LBR, LBMF Series	Inductance change:Within±10% No significant abnormality in appearance.
CB, CBC, CBL, CBMF Series	
LBM, LEM Series	Inductance change:Within±5% No significant abnormality in appearance.
[Test Methods and Remarks]	
LEM·LB·LBC·LBR·CB·CBC·CBL·LBM·LBMF·CBMF : According to JIS C5102 clause 8.2.	
Vibration type : A	
Directions : 2 hrs each in X, Y and Z directions. Total : 6 hrs	
Frequency range : 10 to 55 to 10 Hz (1min.)	
Amplitude : 1.5mm	
Mounting method : Soldering onto printed board	
Recovery : At least 2 hrs of recovery under the standard condition after the test, followed by the measurement within 48 hrs.	
LEM : Recovery	
At least 1 hr of recovery under the standard condition after the test, followed by the measurement within 2 hrs.	
13.Drop test	
LB, LBC, LBR, LBMF Series	Inductance change:Within±5% No significant abnormality in appearance.
CB, CBC, CBL, CBMF Series	
LBM Series	
LEM Series	
[Test Methods and Remarks]	
LEM :	
Acceleration : 980m/sec <sup>2</sup>	
Duration : 6msec	
Number of times : 6 sides × 3 times	
Mounting method : Soldering onto printed board	
Recovery : At least 2 hrs of recovery under the standard condition after the test, followed by the measurement within 48 hrs.	
LEM : Recovery	
At least 1 hr of recovery under the standard condition after the test, followed by the measurement within 2 hrs.	
14.Solderability	
LB, LBC, LBR, LBMF Series	At least 90% of surface of terminal electrode is covered by new
CB, CBC, CBL, CBMF Series	
LBM, LEM Series	
[Test Methods and Remarks]	
LEM :	
Solder temperature : 230±5°C	
Duration : 5±0.5sec.	
Flux : Methanol solution with 25% of colophony	
LB·LBC·LBR·CB·CBC·CBL·LBM·LBMF·CBMF :	Solder temperature : 245±5°C
	Duration : 5±0.5sec
	Flux : Methanol solution with 25% of colophony

\* This catalog contains the typical specification only due to the limitation of space. When you consider the purchase of our products, please check our specification.  
For details of each product (characteristics graph, reliability information, precautions for use, and so on), see our Web site (<http://www.ty-top.com/>) or CD catalogs.

## RELIABILITY DATA

### 15. Resistance to soldering

LB, LBC, LBR, LBMF Series	Inductance change: Within $\pm 10\%$
CB, CBC, CBL, CBMF Series	
LEM Series	Inductance change: Within $\pm 5\%$
LEM2520	No significant abnormality in appearance.

#### [Test Methods and Remarks]

LEM :  
 Reflow condition 3 times of reflow over at  $220 \pm 5^\circ\text{C}$  for 40sec. MAX, With Peak temperature at  $240 \pm 5^\circ\text{C}$  for 5 sec.  
 MAX. (Refer to a Profile of chart below.)

Flow condition  
 Solder temperature :  $260 \pm 5^\circ\text{C}$   
 Duration :  $10 \pm 1$ sec. Once

LB · LBC · LBR · CB · CBC · CBL · LBM · LBMF · CBMF :  
 3 times of reflow oven at  $230^\circ\text{C}$  MIN for 40sec. with peak temperature at  $260^\circ\text{C}$  for 5sec.

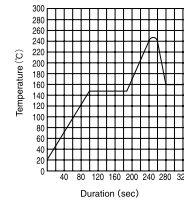

### 16. Resistance to solvent

LB, LBC, LBR, LBMF Series	No significant abnormality in appearance
CB, CBC, CBL, CBMF Series	
LBM, LEM Series	

#### [Test Methods and Remarks]

Solvent temperature : Room temperature  
 Type of solvent : Isopropyl alcohol  
 Cleaning conditions : 90s. Immersion and cleaning.

### 17. Thermal shock

LB, LBC, LBR, LBMF Series	Inductance change: Within $\pm 10\%$	No significant abnormality in appearance.
CB, CBC, CBL, CBMF Series		
LBM Series		
LEM Series	Inductance change : Within $\pm 10\%$ Q → R12~4R7 : 30 min. 5R6~330 : 25 min. 390~820 : 20 min. 101 : 15 min.	

#### [Test Methods and Remarks]

LEM : Conditions for 1 cycle

Step	Temperature ( $^\circ\text{C}$ )	Duration (min)
1	-40	30
2	+85	30

Number of cycle : 100 cycle  
 Recovery : At least 1 hr of recovery under the standard condition after the test, followed by the measurement within 2 hrs.  
 LB · LBC · LBR · CB · CBC · CBL · LBM · LBMF · CBMF :  $-40 \sim +85^\circ\text{C}$ , maintain times 30min., 100 cycle  
 Recovery : At least 2 hrs of recovery under the standard condition after the test, followed by the measurement within 48 hrs.

### 18. Damp heat life test

LB, LBC, LBR, LBMF Series	Inductance change: Within $\pm 10\%$	No significant abnormality in appearance.
CB, CBC, CBL, CBMF Series		
LBM Series		
LEM Series	Inductance change : Within $\pm 10\%$ Q → R12~4R7 : 30 min. 5R6~330 : 25 min. 390~820 : 20 min. 101 : 15 min.	

#### [Test Methods and Remarks]

Temperature :  $60 \pm 2^\circ\text{C}$   
 Humidity : 90~95%RH  
 Duration : 1000 hrs  
 Recovery : At least 2 hrs of recovery under the standard condition after the test, followed by the measurement within 48 hrs.  
 LEM : Recovery  
 At least 1 hr of recovery under the standard condition after the test, followed by the measurement within 2 hrs.

### 19. Loading under damp heat life test

LB, LBC, LBR, LBMF Series	Inductance change: Within $\pm 10\%$	No significant abnormality in appearance.
CB, CBC, CBL, CBMF Series		
LBM Series		
LEM Series	Inductance change : Within $\pm 10\%$ Q → R12~4R7 : 30 min. 5R6~330 : 25 min. 390~820 : 20 min. 101 : 15 min.	

#### [Test Methods and Remarks]

Temperature :  $60 \pm 2^\circ\text{C}$   
 Humidity : 90~95%RH  
 Duration : 1000 hrs  
 Applied current : Rated current  
 Recovery : At least 2 hrs of recovery under the standard condition after the test, followed by the measurement within 48 hrs.  
 LEM : Recovery  
 At least 1 hr of recovery under the standard condition after the test, followed by the measurement within 2 hrs.

\* This catalog contains the typical specification only due to the limitation of space. When you consider the purchase of our products, please check our specification.  
 For details of each product (characteristics graph, reliability information, precautions for use, and so on), see our Web site (<http://www.ty-top.com/>) or CD catalogs.

## RELIABILITY DATA

20.High temperature life test	
LB, LBC, LBR, LBMF Series	Inductance change:Within±10%      No significant abnormality in appearance.
CB, CBC, CBL, CBMF Series	
LBM Series	
LEM Series	Inductance change :Within±10% Q→ R12~4R7 : 30 min. 5R6~330 : 25 min. 390~820 : 20 min. 101 : 15 min.
<b>[Test Methods and Remarks]</b> Temperature : 85±2°C Duration : 1000 hrs Recovery : At least 2 hrs of recovery under the standard condition after the test, followed by the measurement within 48 hrs. LEM : Recovery At least 1 hr of recovery under the standard condition after the test, followed by the measurement within 2 hrs.	
21.Loading at high temperature life test	
LB, LBC, LBR, LBMF Series	Inductance change:Within±10%      No significant abnormality in appearance.
CB, CBC, CBL, CBMF Series	
LBM, LEM Series	
<b>[Test Methods and Remarks]</b> Temperature : 85±2°C Duration : 1000 hrs Applied current : Rated current Recovery : At least 2 hrs of recovery under the standard condition after the test, followed by the measurement within 48 hrs.	
22.Low temperature life test	
LB, LBC, LBR, LBMF Series	Inductance change:Within±10%      No significant abnormality in appearance.
CB, CBC, CBL, CBMF Series	
LBM Series	
LEM Series	Inductance change :Within±10% Q→ R12~4R7 : 30 min. 5R6~330 : 25 min. 390~820 : 20 min. 101 : 15 min.
<b>[Test Methods and Remarks]</b> Temperature : -40±2°C Duration : 1000 hrs Recovery : At least 2 hrs of recovery under the standard condition after the test, followed by the measurement within 48 hrs. LEM : Recovery At least 1 hr of recovery under the standard condition after the test, followed by the measurement within 2 hrs.	
23.Standard condition	
LB, LBC, LBR, LBMF Series	Standard test conditions Unless specified, Ambient temperature is 20±15°C and the Relative humidity is 65±20%. If there is any doubt about the test results, further measurement shall be had within the following limits: Ambient Temperature: 20±2°C Relative humidity: 65±5% Inductance value is based on our standard measurement systems.
CB, CBC, CBL, CBMF Series	
LBM, LEM Series	

\* This catalog contains the typical specification only due to the limitation of space. When you consider the purchase of our products, please check our specification.  
For details of each product (characteristics graph, reliability information, precautions for use, and so on), see our Web site (<http://www.ty-top.com/>) or CD catalogs.

## PRECAUTIONS

LEM Type, LB Type, CB Type

1. Circuit Design	
Precautions	<ul style="list-style-type: none"> <li>◆ Operating environment               <ol style="list-style-type: none"> <li>1. The products described in this specification are intended for use in general electronic equipment (office supply equipment, telecommunications systems, measuring equipment, and household equipment). They are not intended for use in mission-critical equipment or systems requiring special quality and high reliability (traffic systems, safety equipment, aerospace systems, nuclear control systems and medical equipment including life-support systems,) where product failure might result in loss of life, injury or damage. For such uses, contact TAIYO YUDEN Sales Department in advance.</li> </ol> </li> </ul>
2. PCB Design	
Precautions	<ul style="list-style-type: none"> <li>◆ Land pattern design               <ol style="list-style-type: none"> <li>1. Please contact any of our offices for a land pattern, and refer to a recommended land pattern of a right figure or specifications.</li> </ol> </li> </ul>
Technical considerations	PRECAUTIONS [Recommended Land Patterns] Surface Mounting <ul style="list-style-type: none"> <li>· Mounting and soldering conditions should be checked beforehand.</li> <li>· Applicable soldering process to those products is reflow soldering only.</li> </ul>
3. Considerations for automatic placement	
Precautions	<ul style="list-style-type: none"> <li>◆ Adjustment of mounting machine               <ol style="list-style-type: none"> <li>1. Excessive impact load should not be imposed on the products when mounting onto the PC boards.</li> <li>2. Mounting and soldering conditions should be checked beforehand.</li> </ol> </li> </ul>
Technical considerations	<ol style="list-style-type: none"> <li>1. When installing products, care should be taken not to apply distortion stress as it may deform the products.</li> </ol>
4. Soldering	
Precautions	<ul style="list-style-type: none"> <li>◆ Wave soldering (LEM Type only)               <ol style="list-style-type: none"> <li>1. For wave soldering, please apply conditions meeting the range of the specified conditions in our catalog or the relevant specifications.</li> </ol> </li> <li>◆ Reflow soldering (LB and CB Types)               <ol style="list-style-type: none"> <li>1. For reflow soldering with either leaded or lead-free solder, the profile specified in "point for controlling" is recommended.</li> </ol> </li> <li>◆ Reflow soldering (LEM)               <ol style="list-style-type: none"> <li>1. For reflow soldering, please apply conditions meeting the range of the specified conditions in our catalog or the relevant specifications.</li> </ol> </li> <li>◆ Recommended conditions for using a soldering iron               <ol style="list-style-type: none"> <li>1. Put the soldering iron on the land-pattern. Soldering iron's temperature - Below 350°C Duration-3 seconds or less. The soldering iron should not come in contact with inductor directly.</li> </ol> </li> </ul>
Technical considerations	<ul style="list-style-type: none"> <li>◆ Wave soldering (LEM Type only)               <ol style="list-style-type: none"> <li>1. Components can be damaged by excessive heat where soldering conditions exceed the specified range.</li> </ol> </li> <li>◆ Reflow soldering (LB and CB Types)               <ol style="list-style-type: none"> <li>1. Reflow profile                   <div style="text-align: center;"> <p>Peak Temp: 260+0/-5°C 5 sec Max 230°C Minn 90±30 sec 30±10 sec</p> </div> </li> </ol> </li> <li>◆ Recommended conditions for using a soldering iron               <ol style="list-style-type: none"> <li>1. Components can be damaged by excessive heat where soldering conditions exceed the specified range.</li> </ol> </li> </ul>
5. Cleaning	
Precautions	<ul style="list-style-type: none"> <li>◆ Cleaning conditions               <ol style="list-style-type: none"> <li>1. Washing by supersonic waves shall be avoided.</li> </ol> </li> </ul>
Technical considerations	<ul style="list-style-type: none"> <li>◆ Cleaning conditions               <ol style="list-style-type: none"> <li>1. If washed by supersonic waves, the products might be broken.</li> </ol> </li> </ul>
6. Handling	
Precautions	<ul style="list-style-type: none"> <li>◆ Handling               <ol style="list-style-type: none"> <li>1. There is a case that a characteristic varies with magnetic influence.</li> </ol> </li> <li>◆ Breakaway PC boards (splitting along perforations)               <ol style="list-style-type: none"> <li>1. Planning pattern configurations and the position of products should be carefully performed to minimize stress.</li> </ol> </li> <li>◆ Mechanical considerations               <ol style="list-style-type: none"> <li>1. There is a case to be damaged by a mechanical shock.</li> </ol> </li> </ul>
Technical considerations	<ul style="list-style-type: none"> <li>◆ Handling               <ol style="list-style-type: none"> <li>1. Keep the inductors away from all magnets and magnetic objects.</li> </ol> </li> <li>◆ Breakaway PC boards (splitting along perforations)               <ol style="list-style-type: none"> <li>1. When splitting the PC board after mounting inductors, care should be taken not to give any stresses of deflection or twisting to the board.</li> <li>2. Board separation should not be done manually, but by using the appropriate devices.</li> </ol> </li> <li>◆ Mechanical considerations               <ol style="list-style-type: none"> <li>1. Please do not give the inductors any excessive mechanical shocks.</li> </ol> </li> </ul>
7. Storage conditions	
Precautions	<ul style="list-style-type: none"> <li>◆ Storage               <ol style="list-style-type: none"> <li>1. Under a high temperature and humidity environment, problems such as reduced solderability caused by oxidation of terminal electrodes and deterioration of taping/packaging materials may take place.</li> </ol> </li> </ul>
Technical considerations	<ul style="list-style-type: none"> <li>◆ Storage               <ol style="list-style-type: none"> <li>1. To maintain the solderability of terminal electrodes and to keep the packing material in good condition, temperature and humidity in the storage area should be controlled.                   <ul style="list-style-type: none"> <li>· Recommended conditions Ambient temperature : 0~40°C / Humidity : Below 70% RH</li> </ul>                   The ambient temperature must be kept below 30°C even under ideal storage conditions, solderability of products electrodes may decrease as time passes. For this reason, LE type inductors should be used within one year from the time of delivery.                    LB type : Should be used within 6 months from the time of delivery.                    LE type : In case of storage over 6 months, solderability shall be checked before actual usage.                 </li> </ol> </li> </ul>

\* This catalog contains the typical specification only due to the limitation of space. When you consider the purchase of our products, please check our specification. For details of each product (characteristics graph, reliability information, precautions for use, and so on), see our Web site (<http://www.ty-top.com/>) or CD catalogs.

# WOUND CHIP POWER INDUCTORS(BR SERIES)



REFLOW

## FEATURES

- Suitable for the use as a choke coil in smaller DC/DC converters.

## APPLICATIONS

- BR-series are suitable for an anti-noise measure on the power supply circuit of DSC, DVC, eBOOK, LCD-TV, mobile phones, PC, game equipments, various communication equipments and etc..

## OPERATING TEMP.

- - 40 ~ 105°C (Including-self-generated heat)

## ORDERING CODE

B R △ 2 5 1 8 T 2 R 2 M △ △ △

**1 Type**

BR	Wound Chip Power Inductors
----	----------------------------

**2 Characteristic Spec**

△	Low Rdc
L	Low profile
C	High Current

**3 External Dimensions (W×L) : mm (inch)**

1608 (0603)	1.6×0.8mm
2012 (0805)	2.0×1.2mm
2016 (0806)	2.0×1.6mm
2515 (1006)	2.5×1.5mm
2518 (1007)	2.5×1.8mm
3225 (1210)	3.2×2.5mm

**4 Packaging**

T	Tape & Reel
---	-------------

**5 Nominal Inductance (μH)**

example	
R20	0.2
1R0	1.0
2R2	2.2
4R7	4.7

※R=decimal point

**6 Inductance tolerance**

M	±20%
K	±10%

**7 Internal code**

△△△	Standard product
-----	------------------

△=Blank Space

## EXTERNAL DIMENSIONS/STANDARD QUANTITY

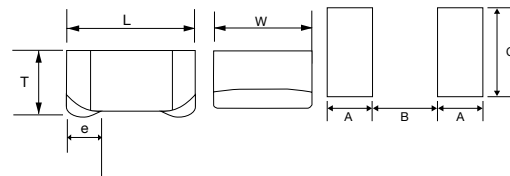

Type	A	B	C
1608	0.55	0.70	1.00
2012	0.60	1.00	1.45
2016	0.60	1.00	1.80
2515	0.60	1.50	1.70
2518	0.60	1.50	2.00
3225	0.85	1.70	2.70

Unit : mm

**Recommended Land Patterns**  
Surface Mounting  
• Mounting and soldering conditions should be checked beforehand.  
• Applicable soldering process to this products is reflow soldering only.

Type	L	W	T	e	Standard Quantity [pcs]	
					Paper Tape	Embossed Tape
BR L1608	1.6±0.2 (0.063±0.008)	0.8±0.2 (0.031±0.008)	0.7 max (0.028 max)	0.45±0.15 (0.016±0.006)	-	3000
BR C1608	1.6±0.2 (0.063±0.008)	0.8±0.2 (0.031±0.008)	0.8±0.2 (0.031±0.008)	0.45±0.15 (0.016±0.006)	-	3000
BR L2012	2.00±0.20 (0.078±0.008)	1.25±0.20 (0.049±0.008)	1.00 max (0.040 max)	0.5±0.2 (0.020±0.008)	-	3000
BR C2012	2.00±0.20 (0.078±0.008)	1.25±0.20 (0.049±0.008)	1.4 max (0.056 max)	0.5±0.2 (0.020±0.008)	-	2000
BR C2016	2.00±0.20 (0.078±0.008)	1.6±0.20 (0.063±0.008)	1.6±0.20 (0.063±0.008)	0.5±0.2 (0.020±0.008)	-	2000
BR L2515	2.5±0.2 (0.098±0.008)	1.5±0.2 (0.060±0.008)	1.2 max (0.048 max)	0.5±0.2 (0.020±0.008)	-	2000
BRFL2518	2.5±0.2 (0.098±0.008)	1.8±0.2 (0.071±0.008)	1.00 max (0.040 max)	0.5±0.2 (0.020±0.008)	-	3000
BR L2518	2.5±0.2 (0.098±0.008)	1.8±0.2 (0.071±0.008)	1.2 max (0.048 max)	0.5±0.2 (0.020±0.008)	-	3000
BRHL2518	2.5±0.2 (0.098±0.008)	1.8±0.2 (0.071±0.008)	1.5 max (0.060 max)	0.5±0.2 (0.020±0.008)	-	2000
BR C2518	2.5±0.2 (0.098±0.008)	1.8±0.2 (0.071±0.008)	1.8±0.2 (0.071±0.008)	0.5±0.2 (0.020±0.008)	-	2000
BR L3225	3.2±0.2 (0.126±0.008)	2.5±0.2 (0.098±0.008)	1.7 max (0.068 max)	0.75±0.2 (0.03±0.008)	-	2000

Unit : mm

## AVAILABLE INDUCTANCE RANGE

Range	Type	BR L1608		BR C1608		BR L2012		BR C2012		BR C2016		BR L2515		BRFL2518		BR L2518		BRHL2518		BR C2518		BR L3225	
		Imax [mA]	Rdc±30% [Ω]	Imax [mA]	Rdc±30% [Ω]	Imax [mA]	Rdc±30% [Ω]	Imax [mA]	Rdc±30% [Ω]	Imax [mA]	Rdc±30% [Ω]	Imax [mA]	Rdc±30% [Ω]	Imax [mA]	Rdc±30% [Ω]	Imax [mA]	Rdc±30% [Ω]	Imax [mA]	Rdc±30% [Ω]	Imax [mA]	Rdc±30% [Ω]	Imax [mA]	Rdc±30% [Ω]
0.20				980	0.2μH	1,050	0.47μH																
0.47		650	1μH	520	0.180	850	0.135	1,500	1μH	1,100	1μH	1,500	1μH	1,200	1μH	1,000	1μH	2,000	1μH	1,650	1μH	2,200	1μH
1.0		280	2.2μH					1,000	0.11			1,000	0.135	850	0.135	850	0.135	1,500	0.116				
2.2								700	4.7μH			700	4.7μH	650	4.7μH	470	4.7μH	1,100	4.7μH				
4.7																							
10						270	0.850			450	0.400									610	0.350	700	0.350
22		200	15μH	256																			
47																							
100						85	100μH	770		140	100μH	3.40								190	100μH	3.60	250
																						100μH	2.50

\* This catalog contains the typical specification only due to the limitation of space. When you consider the purchase of our products, please check our specification. For details of each product (characteristics graph, reliability information, precautions for use, and so on), see our Web site (<http://www.ty-top.com/>) or CD catalogs.

**PART NUMBERS**

● 1608(0603)TYPE

Ordering code	EMS	Inductance [μH]	Inductance Tolerance	Self-resonant frequency [MHz](min.)	DC Resistance [Ω] (±30%)	Rated current ※) [mA]		Measuring frequency [MHz]
						Saturation current Idc1	Temperature rise current Idc2	
BR L1608T1R0M	RoHS	1.0	±20%	700	0.230	510	650	1.0
BR L1608T1R5M	RoHS	1.5		600	0.280	440	590	
BR L1608T2R2M	RoHS	2.2		400	0.400	360	500	
BR L1608T3R3M	RoHS	3.3		300	0.650	290	390	
BR L1608T4R7M	RoHS	4.7		150	1.00	240	310	
BR L1608T6R8M	RoHS	6.8		100	1.64	200	250	
BR L1608T100M	RoHS	10		45	2.00	170	220	
BR L1608T150M	RoHS	15		32	2.56	150	200	

Ordering code	EMS	Inductance [μH]	Inductance Tolerance	Self-resonant frequency [MHz](min.)	DC Resistance [Ω] (±30%)	Rated current ※) [mA]		Measuring frequency [MHz]
						Saturation current Idc1	Temperature rise current Idc2	
BR C1608TR20M	RoHS	0.20	±20%	400	0.060	1,750	980	7.96
BR C1608TR35M	RoHS	0.35		300	0.080	1,400	810	
BR C1608TR45M	RoHS	0.45		200	0.090	1,250	800	
BR C1608TR56M	RoHS	0.56		170	0.095	1,150	760	
BR C1608TR77M	RoHS	0.77		150	0.110	1,000	660	
BR C1608T1R0M	RoHS	1.00		140	0.180	850	520	
BR C1608T1R5M	RoHS	1.50		120	0.300	700	410	
BR C1608T2R2M	RoHS	2.20		100	0.550	550	280	

● 2012(0805)TYPE

Ordering code	EMS	Inductance [μH]	Inductance Tolerance	Self-resonant frequency [MHz](min.)	DC Resistance [Ω] (±30%)	Rated current ※) [mA]		Measuring frequency [MHz]
						Saturation current Idc1	Temperature rise current Idc2	
BR L2012TR47M	RoHS	0.47	±20%	350	0.090	1,100	1,050	7.96
BR L2012T1R0M	RoHS	1.0		300	0.135	850	850	
BR L2012T1R5M	RoHS	1.5		250	0.180	700	750	
BR L2012T2R2M	RoHS	2.2		200	0.300	600	550	
BR L2012T3R3M	RoHS	3.3		190	0.500	490	440	
BR L2012T4R7M	RoHS	4.7		150	0.550	340	400	2.52
BR L2012T6R8M	RoHS	6.8		60	0.750	290	350	
BR L2012T100M	RoHS	10		30	0.850	270	330	
BR L2012T150M	RoHS	15		15	1.00	220	300	
BR L2012T220M	RoHS	22		13	1.30	190	270	
BR L2012T330M	RoHS	33	8.0	2.00	150	220	0.796	
BR L2012T470M	RoHS	47	7.0	3.50	125	160		
BR L2012T680M	RoHS	68	6.5	5.80	100	110		
BR L2012T101M	RoHS	100	6.0	7.70	85	85		

Ordering code	EMS	Inductance [μH]	Inductance Tolerance	Self-resonant frequency [MHz](min.)	DC Resistance [Ω] (±30%)	Rated current ※) [mA]		Measuring frequency [MHz]
						Saturation current Idc1	Temperature rise current Idc2	
BR C2012T1R0M	RoHS	1.0	±20%	490	0.060	1,500	1,400	1.0
BR C2012T1R5MD	RoHS	1.5		390	0.090	1,200	1100	
BR C2012T2R2MD	RoHS	2.2		350	0.110	1,100	1000	
BR C2012T3R3MD	RoHS	3.3		300	0.170	800	870	
BR C2012T4R7MD	RoHS	4.7		250	0.265	700	600	

● 2016(0806)TYPE

Ordering code	EMS	Inductance [μH]	Inductance Tolerance	Self-resonant frequency [MHz](min.)	DC Resistance [Ω] (±30%)	Rated current ※) [mA]		Measuring frequency [MHz]
						Saturation current Idc1	Temperature rise current Idc2	
BR C2016T1R0M	RoHS	1.0	±20%	450	0.085	1,350	1,100	0.10
BR C2016T1R5M	RoHS	1.5		370	0.150	1,100	820	
BR C2016T2R2M	RoHS	2.2		250	0.180	910	760	
BR C2016T3R3M	RoHS	3.3		140	0.220	740	680	
BR C2016T4R7M	RoHS	4.7		78	0.270	660	610	
BR C2016T6R8M	RoHS	6.8		39	0.330	550	560	
BR C2016T100□	RoHS	10	±10% ±20%	35	0.400	450	520	
BR C2016T150□	RoHS	15		28	0.60	400	410	
BR C2016T220□	RoHS	22		24	1.00	310	310	
BR C2016T330□	RoHS	33		13	1.70	270	240	
BR C2016T470□	RoHS	47		11	2.20	210	210	
BR C2016T680□	RoHS	68		8	2.80	200	190	
BR C2016T101□	RoHS	100	7	3.40	140	170		

• Please specify the inductance tolerance code. (M or K)

※) The saturation current value (Idc1) is the DC current value having inductance decrease down to 30%. (at 20°C)

※) The temperature rise current value (Idc2) is the DC current value having temperature increase up to 40°C. (at 20°C)

\* This catalog contains the typical specification only due to the limitation of space. When you consider the purchase of our products, please check our specification. For details of each product (characteristics graph, reliability information, precautions for use, and so on), see our Web site (<http://www.ty-top.com/>) or CD catalogs.

**PART NUMBERS**

●2515(1006)TYPE

Ordering code	EMS	Inductance [μH]	Inductance Tolerance	Self-resonant frequency [MHz](min.)	DC Resistance [Ω] (±30%)	Rated current ※) [mA]		Measuring frequency [MHz]
						Saturation current Idc1	Temperature rise current Idc2	
BR L2515T1R0M	RoHS	1.0	±20%	160	0.070	1,500	1,350	1.0
BR L2515T1R5M	RoHS	1.5		130	0.100	1,200	1150	
BR L2515T2R2M	RoHS	2.2		100	0.135	1,000	1000	
BR L2515T3R3MD	RoHS	3.3		70	0.215	800	750	
BR L2515T4R7MD	RoHS	4.7		60	0.265	650	700	

●2518(1007)TYPE

Ordering code	EMS	Inductance [μH]	Inductance Tolerance	Self-resonant frequency [MHz](min.)	DC Resistance [Ω] (±30%)	Rated current ※) [mA]		Measuring frequency [MHz]
						Saturation current Idc1	Temperature rise current Idc2	
BRFL2518T1R0M	RoHS	1.0	±20%	130	0.090	1200	1200	1.0
BRFL2518T1R5M	RoHS	1.5		100	0.110	1100	1000	
BRFL2518T2R2M	RoHS	2.2		80	0.130	850	950	
BRFL2518T3R3M	RoHS	3.3		70	0.220	700	700	
BRFL2518T4R7M	RoHS	4.7		60	0.330	650	650	

Ordering code	EMS	Inductance [μH]	Inductance Tolerance	Self-resonant frequency [MHz](min.)	DC Resistance [Ω] (±30%)	Rated current ※) [mA]		Measuring frequency [MHz]
						Saturation current Idc1	Temperature rise current Idc2	
BR L2518T1R0M	RoHS	1.0	±20%	130	0.080	1300	1000	7.96
BR L2518T1R5M	RoHS	1.5		100	0.100	1200	920	
BR L2518T2R2M	RoHS	2.2		80	0.135	900	850	
BR L2518T3R3M	RoHS	3.3		70	0.300	750	580	
BR L2518T4R7M	RoHS	4.7		60	0.400	650	470	

Ordering code	EMS	Inductance [μH]	Inductance Tolerance	Self-resonant frequency [MHz](min.)	DC Resistance [Ω] (±30%)	Rated current ※) [mA]		Measuring frequency [MHz]
						Saturation current Idc1	Temperature rise current Idc2	
BRHL2518T1R0M	RoHS	1.0	±20%	100	0.055	2,000	1,400	1.0
BRHL2518T1R5M	RoHS	1.5		80	0.085	1,700	1100	
BRHL2518T2R2M	RoHS	2.2		68	0.115	1,500	1000	
BRHL2518T3R3MD	RoHS	3.3		54	0.165	1,200	800	
BRHL2518T4R7MD	RoHS	4.7		46	0.245	1,100	750	

Ordering code	EMS	Inductance [μH]	Inductance Tolerance	Self-resonant frequency [MHz](min.)	DC Resistance [Ω] (±30%)	Rated current ※) [mA]		Measuring frequency [MHz]
						Saturation current Idc1	Temperature rise current Idc2	
BR C2518T1R0M	RoHS	1.0	±20%	280	0.050	2,550	1,650	1.0
BR C2518T1R5M	RoHS	1.5		230	0.080	2,100	1300	
BR C2518T2R2M	RoHS	2.2		200	0.120	1,800	1000	
BR C2518T3R3M	RoHS	3.3		150	0.175	1,450	860	
BR C2518T4R7M	RoHS	4.7		100	0.230	1,250	750	
BR C2518T6R8M	RoHS	6.8		45	0.280	1050	680	
BR C2518T100□	RoHS	10	±10% ±20%	20	0.350	890	610	
BR C2518T150□	RoHS	15		13	0.43	760	550	
BR C2518T220□	RoHS	22		10	0.56	640	490	
BR C2518T330□	RoHS	33		8	0.85	560	390	
BR C2518T470□	RoHS	47		6.5	1.45	410	300	
BR C2518T680□	RoHS	68		5.5	2.40	340	230	
BR C2518T101□	RoHS	100	4.5	3.60	300	190		

●3225(1210)TYPE

Ordering code	EMS	Inductance [μH]	Inductance Tolerance	Self-resonant frequency [MHz](min.)	DC Resistance [Ω] (±30%)	Rated current ※) [mA]		Measuring frequency [MHz]
						Saturation current Idc1	Temperature rise current Idc2	
BR L3225TR27M	RoHS	0.27	±20%	390	0.022	4,500	2,850	7.96
BR L3225TR36M	RoHS	0.36		350	0.025	4,300	2,750	
BR L3225TR51M	RoHS	0.51		270	0.029	3,600	2,550	

Ordering code	EMS	Inductance [μH]	Inductance Tolerance	Self-resonant frequency [MHz](min.)	DC Resistance [Ω] (±20%)	Rated current ※) [mA]		Measuring frequency [MHz]
						Saturation current Idc1	Temperature rise current Idc2	
BR L3225T1R0M	RoHS	1.0	±20%	220	0.043	2,400	2,200	0.1
BR L3225T1R5M	RoHS	1.5		170	0.045	2,200	1,750	
BR L3225T2R2M	RoHS	2.2		150	0.065	1,850	1,600	
BR L3225T3R3M	RoHS	3.3		140	0.120	1,450	1,200	
BR L3225T4R7M	RoHS	4.7		120	0.180	1,300	1,000	
BR L3225T6R8M	RoHS	6.8		90	0.270	1,050	770	
BR L3225T100□	RoHS	10	±10% ±20%	70	0.350	900	700	
BR L3225T150□	RoHS	15		20	0.570	700	530	
BR L3225T220□	RoHS	22		13	0.690	550	470	
BR L3225T330□	RoHS	33		9	0.840	470	420	
BR L3225T470□	RoHS	47		7	1.00	420	390	
BR L3225T680□	RoHS	68		6	1.40	330	300	
BR L3225T101□	RoHS	100	5	2.50	270	250		

• Please specify the inductance tolerance code. (M or K)

※) The saturation current value (Idc1) is the DC current value having inductance decrease down to 30%. (at 20°C)

※) The temperature rise current value (Idc2) is the DC current value having temperature increase up to 40°C. (at 20°C)

\* This catalog contains the typical specification only due to the limitation of space. When you consider the purchase of our products, please check our specification. For details of each product (characteristics graph, reliability information, precautions for use, and so on), see our Web site (<http://www.ty-top.com/>) or CD catalogs.



DC Bias characteristics

Measured by HP4285A

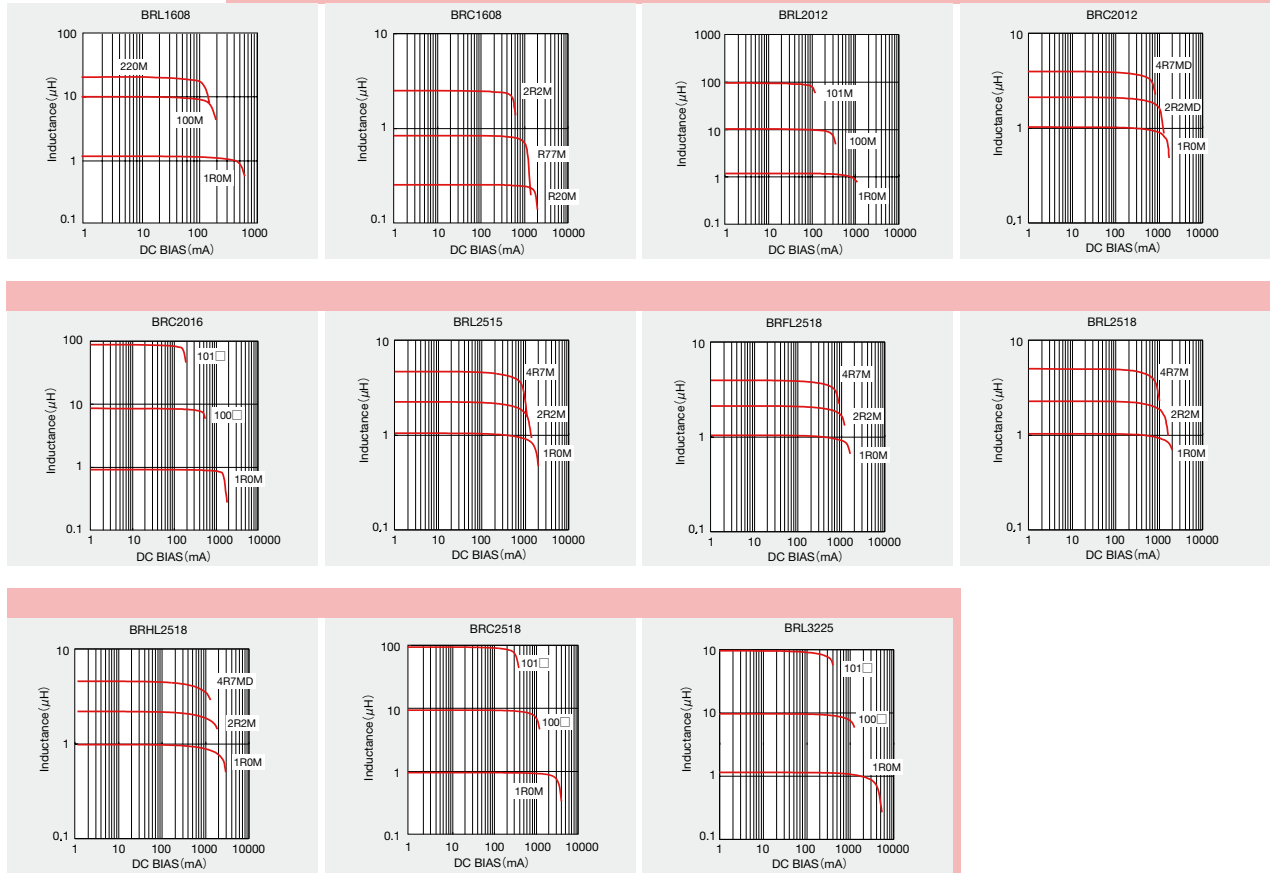

FERRITE PRODUCTS

\* This catalog contains the typical specification only due to the limitation of space. When you consider the purchase of our products, please check our specification. For details of each product (characteristics graph, reliability information, precautions for use, and so on), see our Web site (<http://www.ty-top.com/>) or CD catalogs.

# PACKAGING

## ① Minimum Quantity

Type	Standard Quantity [pcs]	
	Paper Tape	Embossed Tape
BR C1608	—	3,000
BR L1608	—	3,000
BR L2012	—	3,000
BR C2012	—	2,000
BR C2016	—	2,000
BR L2515	—	2,000
BR C2518	—	2,000
BRHL2518	—	2,000
BR L2518	—	3,000
BRFL2518	—	3,000
BR L3225	—	2,000

## ② Tape Material

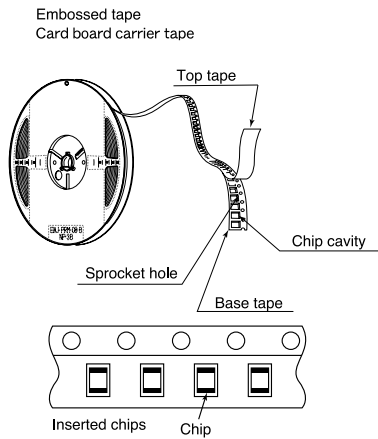

## ③ Taping dimensions

- Embossed Tape 8mm wide (0.315 inches wide)
- Card board carrier tape 8mm wide (0.315 inches wide)

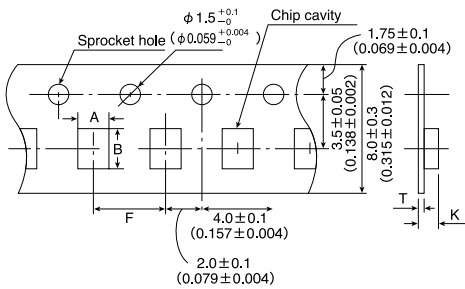

形式	Chip cavity		Insertion pitch F	Tape thickness	
	A	B		T	K
BR L1608	1.10±0.05 (0.044±0.002)	1.90±0.05 (0.076±0.002)	4.0±0.1 (0.157±0.004)	0.20±0.05 (0.008±0.002)	0.85MAX (0.034MAX)
BR C1608	1.10±0.05 (0.044±0.002)	1.90±0.05 (0.076±0.002)	4.0±0.1 (0.157±0.004)	0.25±0.05 (0.01±0.002)	1.35MAX (0.054MAX)
BR L2012	1.45±0.10 (0.058±0.004)	2.20±0.10 (0.088±0.004)	4.0±0.1 (0.157±0.004)	0.25±0.05 (0.01±0.002)	1.2MAX (0.048MAX)
BR C2012	1.45±0.10 (0.058±0.004)	2.37±0.1 (0.095±0.004)	4.0±0.1 (0.157±0.004)	0.25±0.05 (0.01±0.002)	1.59MAX (0.064MAX)
BR C2016	1.9±0.20 (0.075±0.008)	2.2±0.20 (0.087±0.008)	4.0±0.1 (0.157±0.004)	0.3±0.05 (0.012±0.002)	2.15MAX (0.085MAX)
BR L2515	1.80±0.20 (0.072±0.008)	2.80±0.20 (0.112±0.008)	4.0±0.1 (0.157±0.004)	0.25±0.05 (0.01±0.002)	1.45MAX (0.058MAX)
BRFL2518	2.15±0.2 (0.085±0.008)	2.8±0.10 (0.112±0.004)	4.0±0.1 (0.157±0.004)	0.25±0.05 (0.01±0.002)	1.25MAX (0.05MAX)
BR L2518	2.3±0.1 (0.092±0.004)	2.8±0.10 (0.112±0.004)	4.0±0.1 (0.157±0.004)	0.3±0.05 (0.012±0.002)	1.5 MAX (0.060)
BRHL2518	2.10±0.1 (0.084±0.04)	2.80±0.1 (0.112±0.004)	4.0±0.1 (0.157±0.004)	0.3±0.05 (0.012±0.002)	1.70MAX (0.068MAX)
BR C2518	2.15±0.2 (0.085±0.008)	2.7±0.2 (0.107±0.008)	4.0±0.1 (0.157±0.004)	0.3±0.05 (0.012±0.002)	2.10MAX (0.083MAX)
BR L3225	2.80±0.10 (0.112±0.004)	3.5±0.10 (0.140±0.004)	4.0±0.1 (0.157±0.004)	0.25±0.05 (0.01±0.002)	1.75MAX (0.075)

Unit : mm (inch)

## ④ Leader and Blank portion

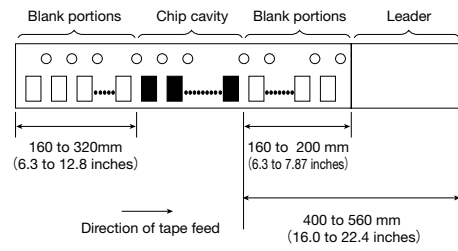

## ⑤ Reel size

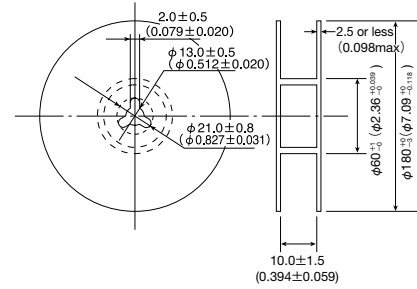

## ⑥ Top Tape Strength

The top tape requires a peel-off force of 0.2 to 0.7N in the direction of the arrow as illustrated below.

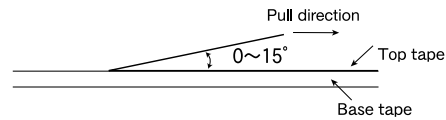

\* This catalog contains the typical specification only due to the limitation of space. When you consider the purchase of our products, please check our specification. For details of each product (characteristics graph, reliability information, precautions for use, and so on), see our Web site (<http://www.ty-top.com/>) or CD catalogs.

## RELIABILITY DATA

### Wound Chip power inductor(BR-series)

<b>1. Operating Temperature Range</b>																											
All of BR-series	-40~+105°C																										
【Test Method and Remarks】 Including self-generated heat																											
<b>2. Storage Temperature Range(after soldering)</b>																											
All of BR-series	-40~+85°C																										
【Test Method and Remarks】 Please refer the term of "7.Storage conditions" in Precautions.																											
<b>3. Rated current</b>																											
All of BR-series	Within the specified tolerance																										
<b>4. Inductance</b>																											
All of BR-series	Within the specified tolerance																										
【Test Method and Remarks】 LCR Meter : HP 4285A or equivalent, Measuring frequency : Specified frequency																											
<b>5. DC Resistance</b>																											
All of BR-series	Within the specified tolerance																										
【Test Method and Remarks】 DC ohmmeter : HIOKI 3227 or equivalent																											
<b>6. Self resonance frequency</b>																											
All of BR-series	Within the specified tolerance																										
【Test Method and Remarks】 Impedance analyzer/material analyzer : HP4291A or equivalent HP4191A, 4192A or equivalent																											
<b>7. Temperature characteristic</b>																											
All of BR-series	Inductance change : Within $\pm 15\%$																										
【Test Method and Remarks】 Based on the inductance at 20°C and Measured at the ambient of -40°C~+85°C.																											
<b>8. Resistance to the bendability</b>																											
All of BR-series	No damage.																										
【Test Method and Remarks】 The given sample is soldered on the board and then the back side of the board is pushed until it bends 2mm like the figure. Dimension of the board : 100×40×1.0mm (0.8mm thickness for 1608(0603) inductors) Material of the board : Glass-epoxy Thickness of soldering paste : 0.12mm																											
<table border="1"> <thead> <tr> <th>Type</th> <th>A</th> <th>B</th> <th>C</th> </tr> </thead> <tbody> <tr> <td>1608</td> <td>0.55</td> <td>0.80</td> <td>1.00</td> </tr> <tr> <td>2012</td> <td>0.65</td> <td>0.90</td> <td>1.40</td> </tr> <tr> <td>2016</td> <td>0.70</td> <td>0.60</td> <td>1.80</td> </tr> <tr> <td>2518</td> <td>0.65</td> <td>1.50</td> <td>1.95</td> </tr> <tr> <td>3225</td> <td>1.00</td> <td>1.60</td> <td>2.70</td> </tr> </tbody> </table>				Type	A	B	C	1608	0.55	0.80	1.00	2012	0.65	0.90	1.40	2016	0.70	0.60	1.80	2518	0.65	1.50	1.95	3225	1.00	1.60	2.70
Type	A	B	C																								
1608	0.55	0.80	1.00																								
2012	0.65	0.90	1.40																								
2016	0.70	0.60	1.80																								
2518	0.65	1.50	1.95																								
3225	1.00	1.60	2.70																								
Unit : mm																											
<b>9. Temperature characteristic</b>																											
All of BR-series	No damage.																										
【Test Method and Remarks】 2012~ Applied force : 10N Duration : 10sec. 1608size Applied force : 5N Duration : 10sec.																											
<b>10. Adhesion of terminal electrodes</b>																											
All of BR-series	Not to removed from the board.																										
【Test Method and Remarks】 The given sample is soldered to the board and then it is kept for 5sec with 10N stress (5N for 1608(0603) inductors) like the figure.																											
<b>11. Resistance to vibration</b>																											
All of BR-series	Inductance change : Within $\pm 10\%$ No significant abnormality in appearance.																										
【Test Method and Remarks】 The given sample is soldered to the board and then it is tested depending on the conditions of the following table.																											
<table border="1"> <tbody> <tr> <td>Vibration Frequency</td> <td colspan="3">10~55Hz</td> </tr> <tr> <td>Total Amplitude</td> <td colspan="3">1.5mm (May not exceed acceleration 196m/s<sup>2</sup>)</td> </tr> <tr> <td>Sweeping Method</td> <td colspan="3">10Hz to 55Hz to 10Hz for 1min.</td> </tr> <tr> <td rowspan="3">Time</td> <td>X</td> <td rowspan="3">For 2 hours on each X, Y, and Z axis.</td> <td rowspan="3"></td> </tr> <tr> <td>Y</td> </tr> <tr> <td>Z</td> </tr> </tbody> </table>				Vibration Frequency	10~55Hz			Total Amplitude	1.5mm (May not exceed acceleration 196m/s <sup>2</sup> )			Sweeping Method	10Hz to 55Hz to 10Hz for 1min.			Time	X	For 2 hours on each X, Y, and Z axis.		Y	Z						
Vibration Frequency	10~55Hz																										
Total Amplitude	1.5mm (May not exceed acceleration 196m/s <sup>2</sup> )																										
Sweeping Method	10Hz to 55Hz to 10Hz for 1min.																										
Time	X	For 2 hours on each X, Y, and Z axis.																									
	Y																										
	Z																										
Recovery : At least 2hrs of recovery under the standard condition after the test, followed by the measurement within 48hrs.																											

\* This catalog contains the typical specification only due to the limitation of space. When you consider the purchase of our products, please check our specification.  
For details of each product (characteristics graph, reliability information, precautions for use, and so on), see our Web site (<http://www.ty-top.com/>) or CD catalogs.

## RELIABILITY DATA

### Wound Chip power inductor(BR-series)

#### 12. Solderability

All of BR-series | At least 90% area of the electrodes is covered by new solder.

##### [Test Method and Remarks]

The given sample is dipped into the flux and then it is tested depending on the conditions of the following table.  
Flux : Methanol solution containing rosin 25%.

Solder Temperature	245±5°C
Time	5±0.5 sec.

#### 13. Resistance to soldering heat

All of BR-series | Inductance change : Within ±10%  
No significant abnormality in appearance.

##### [Test Method and Remarks]

3 times reflow having the temperature profile of 5sec of 260<sup>+0</sup><sub>-5</sub> °C and 40sec of more than 230°C.

Test board thickness : 1.0mm

Test board material : glass epoxy-resin

#### 14. Thermal shock

All of BR-series | Inductance change : Within ±10%  
No significant abnormality in appearance.

##### [Test Method and Remarks]

The given sample is soldered to the board and then its Inductance is measured after 100cycles of the following conditions.

Conditions of 1 cycle		
Step	Temperature (°C)	Duration (min)
1	-40±3	30±3
2	Room temperature	Within 3
3	+85±2	30±3
4	Room temperature	Within 3

#### 15. Damp heat

All of BR-series | Inductance change : Within ±10%  
No significant abnormality in appearance.

##### [Test Method and Remarks]

The given sample is soldered to the board and then it is kept at the following conditions.

Temperature	60±2°C
Humidity	90~95%RH
Time	1000 hours.

Recovery : At least 2hrs of recovery under the standard condition after the test, followed by the measurement within 48 hrs.

#### 16. Loading under damp heat

All of BR-series | Inductance change : Within ±10%  
No significant abnormality in appearance.

##### [Test Method and Remarks]

The given sample is soldered to the board and then it is kept at the following conditions.

Temperature	60±2°C
Humidity	90~95%RH
Applied current	Rated current
Time	1000hours.

Recovery : At least 2hrs of recovery under the standard condition after the test, followed by the measurement within 48 hrs.

#### 17. Low temperature life test

All of BR-series | Inductance change : Within ±10%  
No significant abnormality in appearance.

##### [Test Method and Remarks]

The given sample is soldered to the board and then it is kept at the following conditions.

Temperature	-40±2°C
Duration	1000hours

Recovery : At least 2hrs of recovery under the standard condition after the test, followed by the measurement within 48 hrs.

#### 18. High temperature life test

All of BR-series | Inductance change : Within ±10%  
No significant abnormality in appearance.

##### [Test Method and Remarks]

The given sample is soldered to the board and then it is kept at the following conditions.

Temperature	85±2°C
Duration	1000hours

Recovery : At least 2hrs of recovery under the standard condition after the test, followed by the measurement within 48 hrs.

#### 19. Standard conditions

All of BR-series | Standard test condition :  
Unless otherwise specified, temperature is 20±15°C and 65±20% of relative humidity.  
When there is any question concerning measurement result: In order to provide correlation data, the test shall be condition of 20±2°C of temperature, 65±5% relative humidity.  
Inductance is in accordance with our measured value.

\* This catalog contains the typical specification only due to the limitation of space. When you consider the purchase of our products, please check our specification.  
For details of each product (characteristics graph, reliability information, precautions for use, and so on), see our Web site (<http://www.ty-top.com/>) or CD catalogs.

## PRECAUTIONS

### Wound Chip power inductor(BR-series)

1. Circuit Design	
Precautions	<ul style="list-style-type: none"> <li>◆ Operating Ambient The products are premised on the usage for the general equipments like the office supply equipment, the telecommunications systems, the measuring equipment, the household equipment and so on. Please ask to TAIYO YUDEN's sales person in advance, if you need to apply them to the equipments or the systems which might have any influences for the human body, the property, like the traffic systems, the safety equipment, the aerospace systems, the nuclear control systems, the medical equipment and so on.</li> </ul>
2. PCB Design	
Precautions	<ul style="list-style-type: none"> <li>◆ Land pattern design 1. Please refer to a recommended land pattern.</li> </ul>
Technical considerations	<ul style="list-style-type: none"> <li>◆ Land pattern design Surface Mounting 1. The conditions of the picking and placing should be checked in advance. 2. The products are only for reflow soldering.</li> </ul>
3. Considerations for automatic placement	
Precautions	<ul style="list-style-type: none"> <li>◆ Adjustment of mounting machine 1. Excessive physical impact should not be imposed on the products for picking and placing onto the PC boards. 2. Mounting and soldering conditions should be checked in advance.</li> </ul>
Technical considerations	<ul style="list-style-type: none"> <li>◆ Adjustment of mounting machine The products might be broken if too much stress is given for the picking and placing.</li> </ul>
4. Soldering	
Precautions	<ul style="list-style-type: none"> <li>◆ Reflow soldering 1. Please apply our recommended soldering conditions on the specification as much as possible. 2. The products are only for reflow soldering. 3. Please do not give any stress to a product until it returns in room temperature after reflow soldering.</li> <li>◆ Lead free soldering 1. Please check the adhesion, the solder temperature, the solderability and the shape of solder fillet if the solder that is not in the specification is used.</li> <li>◆ Recommended conditions for using a soldering iron (NR10050 Type) Touch a soldering iron to the land pattern not to the product directly. The temperature of a soldering iron is less than 350degC. The soldering is for 3 seconds or less.</li> </ul>
Technical considerations	<ul style="list-style-type: none"> <li>◆ Reflow soldering 1. The product might break or might make the tombstoning, if the soldering conditions are too far from our recommended conditions.</li> </ul>
5. Cleaning	
Precautions	<ul style="list-style-type: none"> <li>◆ Cleaning conditions 1. Please don't wash by the ultra-sonic waves.</li> </ul>
Technical considerations	<ul style="list-style-type: none"> <li>◆ Cleaning conditions 1. Washing by the ultra-sonic waves might break the product.</li> </ul>
6. Handling	
Precautions	<ul style="list-style-type: none"> <li>◆ Handling 1. Keep the product away from any magnets.</li> <li>◆ Cutting the PC boards 1. Please don't give any stress of the bending or the twisting for the cutting process of PC boards. 2. Please don't give any shock and stress to the products in transportation.</li> <li>◆ Mechanical considerations 1. Please don't give too much shock to the product. 2. Please don't give any shock and stress to the products in transportation.</li> <li>◆ The stress for picking and placing 1. Please don't give any shock into an exposed ferrite core.</li> <li>◆ Packing 1. Please don't pile the packing boxes up as much as possible.</li> </ul>
Technical considerations	<ul style="list-style-type: none"> <li>◆ Cutting the PC boards 1. Please don't give the bending stress or the twisting stress to the products because they might break in such cases.</li> <li>◆ Mechanical considerations 1. The mechanical shock might break the products. 2. The products might break depending on the handling in transportation.</li> <li>◆ Pick-up pressure 1. The electrical characteristics of the products might be shifted by too much physical shock and stress.</li> <li>◆ Packing 1. The products and the tape might break, if the packing boxes are piled up.</li> </ul>
7. Storage conditions	
Precautions	<ul style="list-style-type: none"> <li>◆ Storage 1. The packing boxes can be kept at the ambient which the temperature is from 0 to 40degC and the humidity is less than 70%. 2. The ambient temperature of less than 30degC is recommended not to get the tape and the solderability worse. 3. Please solder the products by a half year after they have been shipped. Otherwise please use them after checking the solderability in advance.</li> </ul>
Technical considerations	<ul style="list-style-type: none"> <li>◆ Storage 1. The ambient of high temperature or high humidity might accelerate to make the solderability and the tape worse.</li> </ul>

\* This catalog contains the typical specification only due to the limitation of space. When you consider the purchase of our products, please check our specification. For details of each product (characteristics graph, reliability information, precautions for use, and so on), see our Web site (<http://www.ty-top.com/>) or CD catalogs.

# SMD INDUCTORS LOW PROFILE TYPE



REFLOW

## FEATURES

- Small and Low profile inductor.
- It corresponds to High current.
- Simple and original magnetic shield structure.
- Durable structure against dropping impact.

## APPLICATIONS

- For small DC/DC converter (cellular Phone, HDD, DVC, DSC, PDA, LCD display etc).

## OPERATING TEMP.

- -25°C~120°C (Including self-generated heat)

## ORDERING CODE

N R △ 4 0 1 8 T △ 1 0 0 M △

<b>1 Type</b> NR△ Coating resin specification △=Blank Space		<b>3 Packaging</b> T△ Tape & Reel △=Blank Space		<b>4 Nominal inductance (μH)</b> example 2R2 2.2 100 10 101 100 ※R=decimal point		<b>5 Inductance tolerance</b> M ±20% N ±30%		<b>6 Internal code</b> △ Standard product △=Blank Space	
---	--	---	--	---	--	---	--	---	--

2 External dimensions (W×L×H)			
3010	3.0×3.0×1.0mm	5040	5.0×5.0×4.0mm
3012	3.0×3.0×1.2mm	6012	6.0×6.0×1.2mm
3015	3.0×3.0×1.5mm	6020	6.0×6.0×2.0mm
4010	4.0×4.0×1.0mm	6028	6.0×6.0×2.8mm
4012	4.0×4.0×1.2mm	6045	6.0×6.0×4.5mm
4018	4.0×4.0×1.8mm	8040	8.0×8.0×4.0mm

## EXTERNAL DIMENSIONS/STANDARD QUANTITY

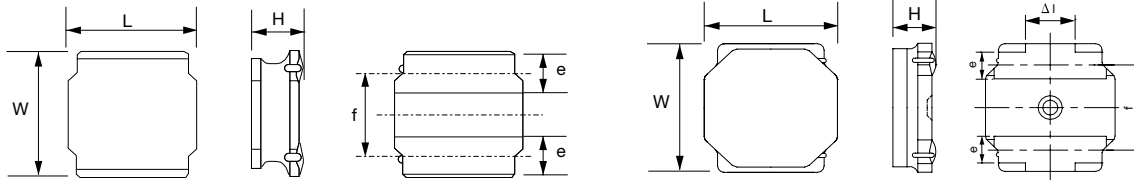

Type	L	W	H	e	f	Standard Quantity [pcs] Tape & Reel
NR3010			1.0 max (0.039 max)			2000
NR3012	3.0±0.1 (0.118±0.004)	3.0±0.1 (0.118±0.004)	1.2 max (0.047 max)	0.9±0.2 (0.035±0.008)	1.9±0.2 (0.075±0.008)	2000
NR3015			1.5 max (0.059 max)			2000
NR4010			1.0 max (0.039 max)			5000
NR4012			1.2 max (0.047 max)			4500
NR4018	4.0±0.2 (0.157±0.008)	4.0±0.2 (0.157±0.008)	1.8 max (0.071 max)	1.1±0.2 (0.043±0.008)	2.5±0.2 (0.098±0.008)	3500
NR8040	8.0±0.2 (0.315±0.008)	8.0±0.2 (0.315±0.008)	*1) 4.2max (0.165max) *2) 4.0max (0.157max)	1.6±0.3 (0.063±0.012)	5.6±0.3 (0.220±0.012)	1000

Type	L	W	H	e	f	ΔI	Standard Quantity [pcs] Tape & Reel
NR6040	4.9±0.2 (0.193±0.008)	4.9±0.2 (0.193±0.008)	*3) 4.1max (0.161max) *4) 4.0max (0.157max)	1.2±0.2 (0.047±0.008)	3.3±0.2 (0.130±0.008)	1.3±0.3 (0.051±0.011)	1500
NR6012 (E Type)	6.0±0.2 (0.236±0.008)	6.0±0.2 (0.236±0.008)	1.2 max (0.047 max)	1.35±0.2 (0.053±0.008)	4.0±0.2 (0.157±0.008)	2.3±0.3 (0.091±0.011)	1000
NR6020	6.0±0.2 (0.236±0.008)	6.0±0.2 (0.236±0.008)	2.0 max (0.078 max)	1.35±0.2 (0.053±0.008)	4.0±0.2 (0.157±0.008)		2500
NR6028	6.0±0.2 (0.236±0.008)	6.0±0.2 (0.236±0.008)	2.8 max (0.110 max)	1.35±0.2 (0.053±0.008)	4.0±0.2 (0.157±0.008)		2000
NR6045	6.0±0.2 (0.236±0.008)	6.0±0.2 (0.236±0.008)	4.5 max (0.177 max)	1.35±0.2 (0.053±0.008)	4.0±0.2 (0.157±0.008)		1500

\*3) 1R5~100Type  
\*4) 150~470Type

Unit : mm (inch)

\*1) 0R9~6R8 Type  
\*2) 100~101 Type

Unit : mm (inch)

\* This catalog contains the typical specification only due to the limitation of space. When you consider the purchase of our products, please check our specification. For details of each product (characteristics graph, reliability information, precautions for use, and so on), see our Web site (<http://www.ty-top.com/>) or CD catalogs.

Recommended Land Patterns

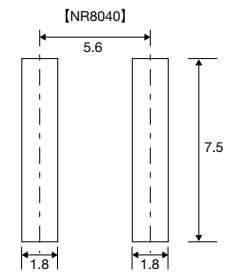
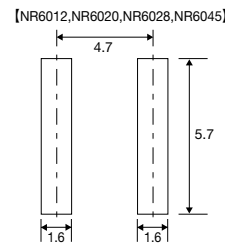
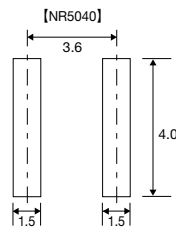
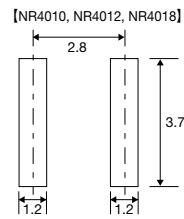
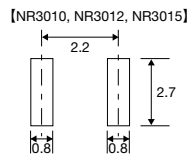

Unit : mm

AVAILABLE INDUCTANCE RANGE

Range	Type	NR 3010		NR 3012		NR 3015		NR 4010		NR 4012		NR 4018		NR 5040		NR 6012		NR 6020		NR 6028		NR 6045		NR 8040			
		IMAX [mA]	Rdc±20% [O]	IMAX [mA]	Rdc±20% [O]	IMAX [mA]	Rdc±20% [O]	IMAX [mA]	Rdc±20% [O]	IMAX [mA]	Rdc±20% [O]	IMAX [mA]	Rdc±20% [O]	IMAX [mA]	Rdc±20% [O]	IMAX [mA]	Rdc±20% [O]	IMAX [mA]	Rdc±20% [O]	IMAX [mA]	Rdc±20% [O]	IMAX [mA]	Rdc±20% [O]	IMAX [mA]	Rdc±20% [O]	IMAX [mA]	Rdc±20% [O]
0.8		1300	0.085	1490	0.05	2100	0.030	1050	0.100	1500	0.060	1830	0.030	3600	0.020	3800	0.020	4600	0.013	4200	0.014	7800	0.006				
1.0																											
3.3		500	0.450	540	0.290	700	0.230	560	0.380	740	0.240	840	0.180	2100	0.056	1730	0.090	1400	0.125	1900	0.065	2500	0.047	3100	0.034		
10																											
47		220	2.05	250	1.45	300	1.34	240	1.81	350	1.00			900	0.310			950	0.290								
100																											
220												170	4.00			320	2.18			620	0.600	700	0.500	1000	0.290		

PART NUMBERS

NR 3010 Shielded type

Ordering code	EHS (Environmental Hazardous Substances)	Inductance [ $\mu$ H]	Inductance Tolerance	Self-resonant frequency [MHz] (min.)	DC Resistance [ $\Omega$ ] ( $\pm 20\%$ )	Rated current ※) [mA]		Measuring frequency [kHz]
						Saturation current Idc1	Temperature rise current Idc2	
NR 3010T 1R0N	RoHS	1.0	$\pm 30\%$	126	0.065	1,300	1,400	100
NR 3010T 1R5N	RoHS	1.5		98	0.080	1,200	1,300	
NR 3010T 2R2M	RoHS	2.2	82	0.095	1,100	1,100		
NR 3010T 3R3M	RoHS	3.3	63	0.140	870	940		
NR 3010T 4R7M	RoHS	4.7	56	0.190	750	780		
NR 3010T 6R8M	RoHS	6.8	46	0.300	610	630		
NR 3010T 100M	RoHS	10	$\pm 20\%$	35	0.450	500	510	
NR 3010T 150M	RoHS	15		30	0.740	400	400	
NR 3010T 220M	RoHS	22		25	1.03	350	350	
NR 3010T 330M	RoHS	33		20	1.55	260	275	
NR 3010T 470M	RoHS	47		17	2.05	220	235	

NR 3012 Shielded type

Ordering code	EHS (Environmental Hazardous Substances)	Inductance [ $\mu$ H]	Inductance Tolerance	Self-resonant frequency [MHz] (min.)	DC Resistance [ $\Omega$ ] ( $\pm 20\%$ )	Rated current ※) [mA]		Measuring frequency [kHz]
						Saturation current Idc1	Temperature rise current Idc2	
NR 3012T 1R0N	RoHS	1.0	$\pm 30\%$	110	0.050	1,500	1,490	100
NR 3012T 1R5N	RoHS	1.5		92	0.060	1,360	1,400	
NR 3012T 2R2M	RoHS	2.2	70	0.080	1,100	1,200		
NR 3012T 3R3M	RoHS	3.3	55	0.100	910	1,050		
NR 3012T 4R7M	RoHS	4.7	48	0.130	770	980		
NR 3012T 6R8M	RoHS	6.8	40	0.190	670	740		
NR 3012T 100M	RoHS	10	$\pm 20\%$	32	0.290	540	630	
NR 3012T 150M	RoHS	15		27	0.450	440	485	
NR 3012T 220M	RoHS	22		22	0.630	375	420	
NR 3012T 330M	RoHS	33		19	1.03	310	330	
NR 3012T 470M	RoHS	47		17	1.45	250	280	

NR 3015 Shielded type

Ordering code	EHS (Environmental Hazardous Substances)	Inductance [ $\mu$ H]	Inductance Tolerance	Self-resonant frequency [MHz] (min.)	DC Resistance [ $\Omega$ ] ( $\pm 20\%$ )	Rated current ※) [mA]		Measuring frequency [kHz]
						Saturation current Idc1	Temperature rise current Idc2	
NR 3015T 1R0N	RoHS	1.0	$\pm 30\%$	100	0.030	2,100	2,100	100
NR 3015T 1R5N	RoHS	1.5		87	0.040	1,800	1,820	
NR 3015T 2R2M	RoHS	2.2	64	0.060	1,480	1,500		
NR 3015T 3R3M	RoHS	3.3	49	0.080	1,210	1,230		
NR 3015T 4R7M	RoHS	4.7	40	0.120	1,020	1,040		
NR 3015T 6R8M	RoHS	6.8	36	0.160	870	880		
NR 3015T 100M	RoHS	10	$\pm 20\%$	28	0.230	700	710	
NR 3015T 150M	RoHS	15		23	0.360	560	560	
NR 3015T 220M	RoHS	22		20	0.520	470	470	
NR 3015T 330M	RoHS	33		18	0.840	390	370	
NR 3015T 470M	RoHS	47		17	1.34	320	300	

※) The saturation current value (Idc1) is the DC current value having inductance decrease down to 30%. (at 20°C)  
 ※) The temperature rise current value (Idc2) is the DC current value having temperature increase up to 40°C. (at 20°C)  
 ※) The rated current is the DC current value that satisfies both of current value saturation current value and temperature rise current value.

\* This catalog contains the typical specification only due to the limitation of space. When you consider the purchase of our products, please check our specification. For details of each product (characteristics graph, reliability information, precautions for use, and so on), see our Web site (<http://www.ty-top.com/>) or CD catalogs.

FERRITE PRODUCTS

## PART NUMBERS

### ● NR 4010 Shielded type

Ordering code	EHS (Environmental Hazardous Substances)	Inductance [ $\mu$ H]	Inductance Tolerance	Self-resonant frequency [MHz] (min.)	DC Resistance [ $\Omega$ ] ( $\pm 20\%$ )	Rated current ※) [mA]		Measuring frequency [kHz]
						Saturation current Idc1	Temperature rise current Idc2	
NR 4010T 1R0N	RoHS	1.0	$\pm 30\%$	116	0.100	1,800	1,050	100
NR 4010T 2R2N	RoHS	2.2		73	0.150	1,150	890	
NR 4010T 3R3M	RoHS	3.3		58	0.180	1,100	820	
NR 4010T 4R7M	RoHS	4.7	$\pm 20\%$	47	0.210	900	750	
NR 4010T 6R8M	RoHS	6.8		38	0.300	740	620	
NR 4010T 100M	RoHS	10		31	0.380	560	600	
NR 4010T 150M	RoHS	15		24	0.510	470	510	
NR 4010T 220M	RoHS	22		19	0.870	360	400	
NR 4010T 330M	RoHS	33		15	1.54	280	300	
NR 4010T 470M	RoHS	47		13	1.81	240	280	

### ● NR 4012 Shielded type

Ordering code	EHS (Environmental Hazardous Substances)	Inductance [ $\mu$ H]	Inductance Tolerance	Self-resonant frequency [MHz] (min.)	DC Resistance [ $\Omega$ ] ( $\pm 20\%$ )	Rated current ※) [mA]		Measuring frequency [kHz]
						Saturation current Idc1	Temperature rise current Idc2	
NR 4012T 1R0N	RoHS	1.0	$\pm 30\%$	131	0.060	2,500	1,500	100
NR 4012T 2R2M	RoHS	2.2		66	0.090	1,650	1,200	
NR 4012T 3R3M	RoHS	3.3	$\pm 20\%$	50	0.130	1,200	980	
NR 4012T 4R7M	RoHS	4.7		45	0.140	1,050	960	
NR 4012T 6R8M	RoHS	6.8		35	0.180	900	840	
NR 4012T 100M	RoHS	10		28	0.240	740	770	
NR 4012T 150M	RoHS	15		23	0.400	560	600	
NR 4012T 220M	RoHS	22		18	0.480	510	540	
NR 4012T 330M	RoHS	33		15	0.810	400	420	
NR 4012T 470M	RoHS	47		12	1.00	350	370	

### ● NR 4018 Shielded type

Ordering code	EHS (Environmental Hazardous Substances)	Inductance [ $\mu$ H]	Inductance Tolerance	Self-resonant frequency [MHz] (min.)	DC Resistance [ $\Omega$ ] ( $\pm 20\%$ )	Rated current ※) [mA]		Measuring frequency [kHz]
						Saturation current Idc1	Temperature rise current Idc2	
NR 4018T 1R0N	RoHS	1.0	$\pm 30\%$	80	0.030	4,000	1,830	100
NR 4018T 2R2M	RoHS	2.2		52	0.060	2,700	1,440	
NR 4018T 3R3M	RoHS	3.3	$\pm 20\%$	44	0.070	2,000	1,230	
NR 4018T 4R7M	RoHS	4.7		34	0.090	1,700	1,200	
NR 4018T 6R8M	RoHS	6.8		29	0.110	1,450	1,060	
NR 4018T 100M	RoHS	10		24	0.180	1,200	840	
NR 4018T 150M	RoHS	15		19	0.250	940	650	
NR 4018T 220M	RoHS	22		16	0.360	800	590	
NR 4018T 330M	RoHS	33		12	0.530	650	490	
NR 4018T 470M	RoHS	47		10	0.650	570	420	
NR 4018T 680M	RoHS	68	8.3	1.00	470	320		
NR 4018T 101M	RoHS	100	6.5	1.50	400	270		
NR 4018T 151M	RoHS	150	5.5	2.50	310	220		
NR 4018T 221M	RoHS	220	4.0	4.00	270	170		

### ● NR 5040 Shielded type

Ordering code	EHS (Environmental Hazardous Substances)	Inductance [ $\mu$ H]	Inductance Tolerance	Self-resonant frequency [MHz] (min.)	DC Resistance [ $\Omega$ ] ( $\pm 30\%$ )	Rated current ※) [mA]		Measuring frequency [kHz]
						Saturation current Idc1	Temperature rise current Idc2	
NR 5040T 1R5N	RoHS	1.5	$\pm 30\%$	60	0.020	6,000	3,600	100
NR 5040T 2R2N	RoHS	2.2		42	0.022	4,600	3,500	
NR 5040T 3R3N	RoHS	3.3		32	0.027	3,800	3,300	
NR 5040T 4R7N	RoHS	4.7	$\pm 20\%$	28	0.029	3,300	3,100	
NR 5040T 6R8M	RoHS	6.8		21	0.049	2,600	2,300	
NR 5040T 100M	RoHS	10		18	0.056	2,300	2,100	
NR 5040T 150M	RoHS	15		13	0.080	2,000	1,800	
NR 5040T 220M	RoHS	22		9	0.126	1,600	1,400	
NR 5040T 330M	RoHS	33		7	0.180	1,300	1,200	
NR 5040T 470M	RoHS	47		6	0.310	1,100	900	

### ● NR 6012 Shielded type

Ordering code	EHS (Environmental Hazardous Substances)	Inductance [ $\mu$ H]	Inductance Tolerance	Self-resonant frequency [MHz] (min.)	DC Resistance [ $\Omega$ ] ( $\pm 20\%$ )	Rated current ※) [mA]		Measuring frequency [kHz]
						Saturation current Idc1	Temperature rise current Idc2	
NR 6012T 2R5NE	RoHS	2.5	$\pm 30\%$	45	0.090	2,100	1,730	100
NR 6012T 4R0NE	RoHS	4.0		39	0.105	1,800	1,570	
NR 6012T 5R3ME	RoHS	5.3	$\pm 20\%$	34	0.125	1,500	1,400	
NR 6012T 6R8ME	RoHS	6.8		30	0.165	1,300	1,180	
NR 6012T 100ME	RoHS	10		22	0.235	1,000	1,000	
NR 6012T 150ME	RoHS	15		18	0.330	800	790	
NR 6012T 220ME	RoHS	22		12	0.530	760	630	
NR 6012T 330ME	RoHS	33		8	0.700	590	530	
NR 6012T 470ME	RoHS	47		6	1.05	520	460	
NR 6012T 680ME	RoHS	68		3	1.35	440	410	
NR 6012T 101ME	RoHS	100	1	2.18	350	320		

※) The saturation current value (Idc1) is the DC current value having inductance decrease down to 30%. (at 20°C)

※) The temperature rise current value (Idc2) is the DC current value having temperature increase up to 40°C. (at 20°C)

※) The rated current is the DC current value that satisfies both of current value saturation current value and temperature rise current value.

\* This catalog contains the typical specification only due to the limitation of space. When you consider the purchase of our products, please check our specification. For details of each product (characteristics graph, reliability information, precautions for use, and so on), see our Web site (<http://www.ty-top.com/>) or CD catalogs.



**PART NUMBERS**

● NR 6020 Shielded type

Ordering code	EHS (Environmental Hazardous Substances)	Inductance [ $\mu$ H]	Inductance Tolerance	Self-resonant frequency [MHz] (min.)	DC Resistance [ $\Omega$ ] ( $\pm 20\%$ )	Rated current ※) [mA]		Measuring frequency [kHz]
						Saturation current Idc1	Temperature rise current Idc2	
NR 6020T 0R8N	RoHS	0.8	$\pm 30\%$	110	0.020	5,500	3,800	100
NR 6020T 1R5N	RoHS	1.5		93	0.026	4,000	3,200	
NR 6020T 2R2N	RoHS	2.2		73	0.034	3,200	2,700	
NR 6020T 3R3N	RoHS	3.3		55	0.040	2,800	2,600	
NR 6020T 4R7N	RoHS	4.7		43	0.058	2,400	2,000	
NR 6020T 6R8N	RoHS	6.8		30	0.085	2,000	1,800	
NR 6020T 100M	RoHS	10	$\pm 20\%$	18	0.125	1,700	1,400	
NR 6020T 220M	RoHS	22		11	0.290	1,050	950	

● NR 6028 Shielded type

Ordering code	EHS (Environmental Hazardous Substances)	Inductance [ $\mu$ H]	Inductance Tolerance	Self-resonant frequency [MHz] (min.)	DC Resistance [ $\Omega$ ] ( $\pm 30\%$ )	Rated current ※) [mA]		Measuring frequency [kHz]
						Saturation current Idc1	Temperature rise current Idc2	
NR 6028T 0R9N	RoHS	0.9	$\pm 30\%$	90	0.013	6,600	4,600	100
NR 6028T 1R5N	RoHS	1.5		78	0.016	5,000	4,200	
NR 6028T 2R2N	RoHS	2.2		68	0.020	4,200	3,700	
NR 6028T 3R0N	RoHS	3.0		55	0.023	3,600	3,400	
NR 6028T 4R7M	RoHS	4.7		39	0.031	2,700	3,000	
NR 6028T 6R0M	RoHS	6.0		30	0.040	2,500	2,500	
NR 6028T 100M	RoHS	10	$\pm 20\%$	20	0.065	1,900	1,900	
NR 6028T 150M	RoHS	15		17	0.095	1,600	1,800	
NR 6028T 220M	RoHS	22		12	0.135	1,300	1,400	
NR 6028T 330M	RoHS	33		10	0.220	1,100	1,100	
NR 6028T 470M	RoHS	47		8	0.300	950	920	
NR 6028T 680M	RoHS	68		5	0.420	760	770	
NR 6028T 101M	RoHS	100		3	0.600	620	660	

● NR 6045 Shielded type

Ordering code	EHS (Environmental Hazardous Substances)	Inductance [ $\mu$ H]	Inductance Tolerance	Self-resonant frequency [MHz] (min.)	DC Resistance [ $\Omega$ ] ( $\pm 30\%$ )	Rated current ※) [mA]		Measuring frequency [kHz]
						Saturation current Idc1	Temperature rise current Idc2	
NR 6045T 1R0N	RoHS	1.0	$\pm 30\%$	110	0.014	8,500	4,200	100
NR 6045T 1R3N	RoHS	1.3		95	0.016	8,000	4,000	
NR 6045T 1R8N	RoHS	1.8		80	0.018	7,000	3,700	
NR 6045T 2R3N	RoHS	2.3		60	0.021	6,000	3,500	
NR 6045T 3R0N	RoHS	3.0		45	0.024	5,000	3,200	
NR 6045T 4R5M	RoHS	4.5		25	0.031	4,000	3,000	
NR 6045T 6R3M	RoHS	6.3	$\pm 20\%$	15	0.038	3,800	2,800	
NR 6045T 100M	RoHS	10		12	0.047	3,000	2,500	
NR 6045T 150M	RoHS	15		10	0.077	2,300	1,900	
NR 6045T 220M	RoHS	22		7	0.115	1,900	1,500	
NR 6045T 330M	RoHS	33		6	0.145	1,500	1,400	
NR 6045T 470M	RoHS	47		5	0.220	1,300	1,100	
NR 6045T 680M	RoHS	68		4	0.330	1,000	900	
NR 6045T 101M	RoHS	100		3	0.500	800	700	

● NR 8040 Shielded type

Ordering code	EHS (Environmental Hazardous Substances)	Inductance [ $\mu$ H]	Inductance Tolerance	Self-resonant frequency [MHz] (min.)	DC Resistance [ $\Omega$ ] ( $\pm 30\%$ )	Rated current ※) [mA]		Measuring frequency [kHz]
						Saturation current Idc1	Temperature rise current Idc2	
NR 8040T 0R9N	RoHS	0.9	$\pm 30\%$	85	0.006	11,000	7,800	100
NR 8040T 1R4N	RoHS	1.4		63	0.007	9,000	7,000	
NR 8040T 2R0N	RoHS	2.0		50	0.009	7,400	6,300	
NR 8040T 3R6N	RoHS	3.6		34	0.015	5,300	4,900	
NR 8040T 4R7N	RoHS	4.7		30	0.018	4,700	4,100	
NR 8040T 6R8N	RoHS	6.8		24	0.025	4,000	3,700	
NR 8040T 100M	RoHS	10	$\pm 20\%$	22	0.034	3,400	3,100	
NR 8040T 150M	RoHS	15		16	0.050	2,700	2,400	
NR 8040T 220M	RoHS	22		13	0.066	2,200	2,200	
NR 8040T 330M	RoHS	33		12	0.100	1,900	1,700	
NR 8040T 470M	RoHS	47		8	0.150	1,500	1,400	
NR 8040T 680M	RoHS	68		7	0.230	1,200	1,100	
NR 8040T 101M	RoHS	100		6	0.290	1,000	1,000	

※) The saturation current value (Idc1) is the DC current value having inductance decrease down to 30%. (at 20°C)  
 ※) The temperature rise current value (Idc2) is the DC current value having temperature increase up to 40°C. (at 20°C)  
 ※) The rated current is the DC current value that satisfies both of current value saturation current value and temperature rise current value.

\* This catalog contains the typical specification only due to the limitation of space. When you consider the purchase of our products, please check our specification. For details of each product (characteristics graph, reliability information, precautions for use, and so on), see our Web site (<http://www.ty-top.com/>) or CD catalogs.



\* This catalog contains the typical specification only due to the limitation of space. When you consider the purchase of our products, please check our specification. For details of each product (characteristics graph, reliability information, precautions for use, and so on), see our Web site (<http://www.ty-top.com/>) or CD catalogs.

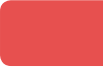

---

\* This catalog contains the typical specification only due to the limitation of space. When you consider the purchase of our products, please check our specification.  
For details of each product (characteristics graph, reliability information, precautions for use, and so on), see our Web site (<http://www.ty-top.com/>) or CD catalogs.

# SMD INDUCTORS SMALL AND LARGE CURRENT TYPE



REFLOW

## FEATURES

- Small and Low profile inductor.
- It corresponds to High current.
- Simple and original magnetic shield structure.
- Durable structure against dropping impact.

## APPLICATIONS

- For small DC/DC converter (cellular Phone, HDD, DVC, DSC, PDA, LCD display etc).

## OPERATING TEMP.

- -25°C~120°C (Including self-generated heat)

## ORDERING CODE

N R H 2 4 1 0 T  $\triangle$  1 0 0 M  $\circ$   $\circ$   $\circ$

**1 Type**

NRH	Coating resin specification
NRS	
NRV	

**3 Packaging**

T $\triangle$	Tape & Reel
---------------	-------------

$\triangle$ =Blank Space

**4 Nominal inductance ( $\mu$ H)**

example	
2R2	2.2
100	10
101	100

\*R=decimal point

**5 Inductance tolerance**

M	$\pm 20\%$
N	$\pm 30\%$

**6 Internal code**

$\circ$ $\circ$ $\circ$	Standard products
$\circ$	Blank Space

**2 External dimensions (W×L×H)**

2410	2.4×2.4×1.0mm	5020	4.9×4.9×1.4mm
3010	3.0×3.0×1.0mm	6010	6.0×6.0×1.0mm
3012	3.0×3.0×1.2mm	6012	6.0×6.0×1.2mm
4010	4.0×4.0×1.0mm	6020	6.0×6.0×2.0mm
4012	4.0×4.0×1.2mm	6028	6.0×6.0×2.8mm
4018	4.0×4.0×1.2mm	6045	6.0×6.0×4.5mm
5012	4.9×4.9×1.2mm	8030	8.0×8.0×3.0mm
5014	4.9×4.9×1.4mm	8040	8.0×8.0×4.0mm

## EXTERNAL DIMENSIONS/STANDARD QUANTITY

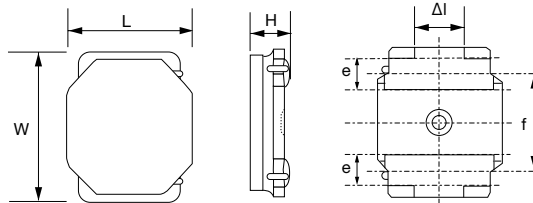
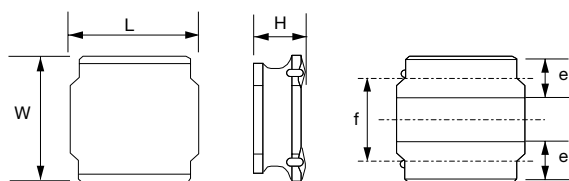

Type	L	W	H	e	f	Standard Quantity [pcs] Tape & Reel
NRH2410	2.4±0.1 (0.095±0.004)	2.4±0.1 (0.095±0.004)	1.0 max (0.039 max)	0.6±0.2 (0.024±0.008)	1.45±0.2 (0.057±0.008)	2500
NRH3010	3.0±0.1 (0.118±0.004)	3.0±0.1 (0.118±0.004)	1.0 max (0.039 max)	0.9±0.2 (0.035±0.008)	1.9±0.2 (0.075±0.008)	2000
NRH3012			1.2 max (0.047 max)			2000
NRV3012			1.0 max (0.039 max)			5000
NRS4010	4.0±0.1 (0.157±0.004)	4.0±0.1 (0.157±0.004)	1.2 max (0.047 max)	1.2±0.2 (0.047±0.008)	2.8±0.2 (0.110±0.008)	4500
NRS4012			1.8 max (0.071 max)			3500
NRS4018			3.0 max (0.118 max)			1000
NRS8030	8.0±0.2 (0.315±0.008)	8.0±0.2 (0.315±0.008)	<sup>*1</sup> 4.2 max (0.165 max)	1.60±0.2 (0.053±0.008)	5.6±0.2 (0.22±0.008)	1000
NRS8040			<sup>*2</sup> 4.0 max (0.157 max)			1000

Type	L	W	H	e	f	ΔI	Standard Quantity [pcs] Tape & Reel
NRS5012			1.2 max (0.047 max)				1000
NRS5014	4.9±0.2 (0.193±0.008)	4.9±0.2 (0.193±0.008)	1.4 max (0.055 max)	1.2±0.2 (0.047±0.008)	3.3±0.2 (0.130±0.008)	1.3±0.3 (0.051±0.011)	1000
NRS5020			2.0 max (0.079 max)				800
NRS6010			1.0 max (0.039 max)				1000
NRS6012			1.2 max (0.047 max)				1000
NRS6020	6.0±0.2 (0.236±0.008)	6.0±0.2 (0.236±0.008)	2.0 max (0.079 max)	1.35±0.2 (0.053±0.008)	4.0±0.2 (0.157±0.008)	2.3±0.3 (0.091±0.011)	2500
NRS6028			2.8 max (0.110 max)				2000
NRS6045			4.5 max (0.177 max)				1500

Unit : mm (inch)

- \*1) 0R9~6R8  
\*2) 100~101

Unit : mm (inch)

## Recommended Land Patterns

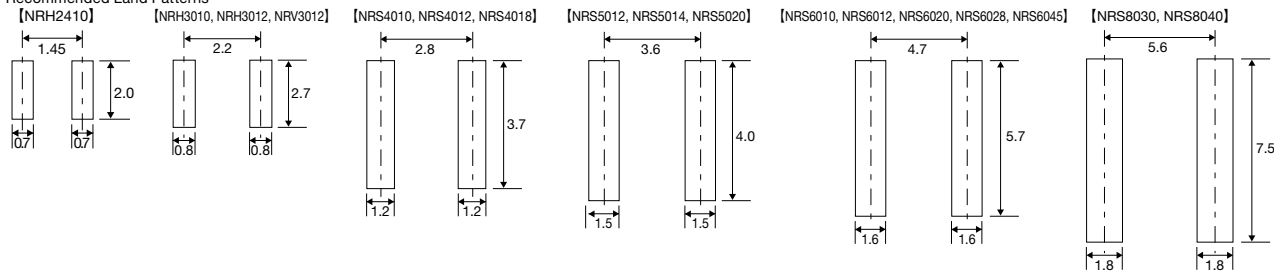

\* This catalog contains the typical specification only due to the limitation of space. When you consider the purchase of our products, please check our specification. For details of each product (characteristics graph, reliability information, precautions for use, and so on), see our Web site (<http://www.ty-top.com/>) or CD catalogs.

AVAILABLE INDUCTANCE RANGE

Range	Type		NRH2410		NRH3010		NRH3012		NRV3012		NRS4010		NRS4012		NRS4018		NRS5012	
	lmax [mA]	Rdc±20% [Ω]	lmax [mA]	Rdc±20% [Ω]	lmax [mA]	Rdc±20% [Ω]	lmax [mA]	Rdc±20% [Ω]	lmax [mA]	Rdc±20% [Ω]	lmax [mA]	Rdc±20% [Ω]	lmax [mA]	Rdc±20% [Ω]	lmax [mA]	Rdc±20% [Ω]	lmax [mA]	Rdc±20% [Ω]
Inductance [μH]	0.68	1570	0.060	1480	0.065	1710	0.048	1600	0.065	1900	0.056	2200	0.042	3200	0.027	2300	0.053	
	1.0																	
	4.7	450	0.690	600	0.350	720	0.270	550	0.470	620	0.300	800	0.170	1200	0.150	850	0.420	
	10	300	1.47	380	0.770											640	0.670	
	22					500	0.630			450	0.570	500	0.400	550	0.460			
	100																	

Range	Type		NRS5014		NRS5020		NRS6010		NRS6012		NRS6020		NRS6028		NRS6045		NRS8030		NRS8040	
	lmax [mA]	Rdc±20% [Ω]	lmax [mA]	Rdc±20% [Ω]	lmax [mA]	Rdc±20% [Ω]	lmax [mA]	Rdc±20% [Ω]	lmax [mA]	Rdc±20% [Ω]	lmax [mA]	Rdc±20% [Ω]	lmax [mA]	Rdc±30% [Ω]	lmax [mA]	Rdc±30% [Ω]	lmax [mA]	Rdc±30% [Ω]	lmax [mA]	Rdc±30% [Ω]
Inductance [μH]	1.0	2800	0.045	3600	0.021	1900	0.090	1730	0.090	4100	0.020	4600	0.013	4500	0.014	6200	0.009	7800	0.006	
	4.7	1800	0.100																	
	10	1050	0.200	1300	0.120	1000	0.270	1000	0.200	1500	0.125	1900	0.065	2400	0.046	2400	0.033	3100	0.034	
	22			900	0.260	650	0.580			950	0.290					1100	0.170	2200	0.066	
	100										620	0.600	750	0.466						

PART NUMBERS

NRH2410 Shielded type

Ordering code	EHS (Environmental Hazardous Substances)	Inductance [μH]	Inductance Tolerance	Self-resonant frequency (MHz) (min.)	DC Resistance [Ω] (±20%)	Rated current ※) [mA]		Measuring frequency [kHz]
						Saturation current ldc1	Temperature rise current ldc2	
NRH2410T R68NN 4	RoHS	0.68	±30%	120	0.060	2,200	1,570	100
NRH2410T 1R0NN 4	RoHS	1.0		106	0.070	1,800	1,410	
NRH2410T 1R5MN	RoHS	1.5	±20%	94	0.110	1,550	1,160	
NRH2410T 2R2MN	RoHS	2.2		77	0.150	1,290	970	
NRH2410T 3R3MN	RoHS	3.3		56	0.220	1,000	770	
NRH2410T 4R7MN	RoHS	4.7		50	0.290	880	670	
NRH2410T 6R8MN	RoHS	6.8		43	0.410	750	570	
NRH2410T 100MN	RoHS	10		32	0.690	550	450	
NRH2410T 150MN	RoHS	15		27	1.02	470	370	
NRH2410T 220MN	RoHS	22		22	1.47	390	300	

NRH3010 Shielded type

Ordering code	EHS (Environmental Hazardous Substances)	Inductance [μH]	Inductance Tolerance	Self-resonant frequency (MHz) (min.)	DC Resistance [Ω] (±20%)	Rated current ※) [mA]		Measuring frequency [kHz]
						Saturation current ldc1	Temperature rise current ldc2	
NRH3010T 1R2NN	RoHS	1.2	±30%	120	0.065	1,700	1,480	100
NRH3010T 1R5NN	RoHS	1.5		99	0.075	1,440	1,370	
NRH3010T 2R2MN	RoHS	2.2	±20%	86	0.083	1,300	1,300	
NRH3010T 3R3MN	RoHS	3.3		64	0.130	1,000	1,030	
NRH3010T 4R7MN	RoHS	4.7		50	0.170	850	900	
NRH3010T 6R8MN	RoHS	6.8		44	0.250	700	745	
NRH3010T 100MN	RoHS	10		34	0.350	600	620	
NRH3010T 150MN	RoHS	15		25	0.550	450	480	
NRH3010T 220MN	RoHS	22		22	0.770	380	410	

NRH3012 Shielded type

Ordering code	EHS (Environmental Hazardous Substances)	Inductance [μH]	Inductance Tolerance	Self-resonant frequency (MHz) (min.)	DC Resistance [Ω] (±20%)	Rated current ※) [mA]		Measuring frequency [kHz]
						Saturation current ldc1	Temperature rise current ldc2	
NRH3012T 1R0NN	RoHS	1.0	±30%	111	0.048	2,200	1,710	100
NRH3012T 1R5NN	RoHS	1.5		95	0.055	1,700	1,600	
NRH3012T 2R2MN	RoHS	2.2	±20%	78	0.075	1,500	1,370	
NRH3012T 3R3MN	RoHS	3.3		61	0.100	1,200	1,210	
NRH3012T 4R7MN	RoHS	4.7		50	0.130	1,000	1,060	
NRH3012T 6R8MN	RoHS	6.8		43	0.190	850	890	
NRH3012T 100MN	RoHS	10		32	0.270	730	720	
NRH3012T 150MN	RoHS	15		26	0.450	530	570	
NRH3012T 220MN	RoHS	22		22	0.630	500	500	

※) The saturation current value (ldc1) is the DC current value having inductance decrease down to 30%. (at 20°C)  
 ※) The temperature rise current value (ldc2) is the DC current value having temperature increase up to 40°C. (at 20°C)  
 ※) The rated current is the DC current value that satisfies both of current value saturation current value and temperature rise current value.

\* This catalog contains the typical specification only due to the limitation of space. When you consider the purchase of our products, please check our specification. For details of each product (characteristics graph, reliability information, precautions for use, and so on), see our Web site (<http://www.ty-top.com/>) or CD catalogs.

**PART NUMBERS**

● **NRV3012 Shielded type**

Ordering code	EHS (Environmental Hazardous Substances)	Inductance [ $\mu$ H]	Inductance Tolerance	Self-resonant frequency [MHz] (min.)	DC Resistance [ $\Omega$ ] ( $\pm 20\%$ )	Rated current ※) [mA]		Measuring frequency [kHz]
						Saturation current Idc1	Temperature rise current Idc2	
NRV3012T 1R0N	RoHS	1.0	$\pm 30\%$	110	0.065	2,500	1,600	100
NRV3012T 1R5N	RoHS	1.5		92	0.075	2,100	1,400	
NRV3012T 2R2M	RoHS	2.2	$\pm 20\%$	70	0.120	1,800	1,100	
NRV3012T 3R3M	RoHS	3.3		55	0.150	1,600	1,000	
NRV3012T 4R7M	RoHS	4.7		48	0.190	1,250	850	
NRV3012T 6R8M	RoHS	6.8		40	0.300	950	650	
NRV3012T 100M	RoHS	10		32	0.470	800	550	

● **NRS4010 Shielded type**

Ordering code	EHS (Environmental Hazardous Substances)	Inductance [ $\mu$ H]	Inductance Tolerance	Self-resonant frequency [MHz] (min.)	DC Resistance [ $\Omega$ ] ( $\pm 20\%$ )	Rated current ※) [mA]		Measuring frequency [kHz]
						Saturation current Idc1	Temperature rise current Idc2	
NRS4010T 1R0NDGG	RoHS	1.0	$\pm 30\%$	116	0.056	2,000	1,900	100
NRS4010T 2R2MDGG	RoHS	2.2		73	0.085	1,200	1,500	
NRS4010T 3R3MDGG	RoHS	3.3	$\pm 20\%$	58	0.100	1,100	1,400	
NRS4010T 4R7MDGG	RoHS	4.7		47	0.140	950	1,200	
NRS4010T 6R8MDGG	RoHS	6.8		38	0.200	800	1,000	
NRS4010T 100MDGG	RoHS	10		31	0.300	620	750	
NRS4010T 150MDGG	RoHS	15		24	0.430	540	600	
NRS4010T 220MDGG	RoHS	22		19	0.570	450	500	

● **NRS4012 Shielded type**

Ordering code	EHS (Environmental Hazardous Substances)	Inductance [ $\mu$ H]	Inductance Tolerance	Self-resonant frequency [MHz] (min.)	DC Resistance [ $\Omega$ ] ( $\pm 20\%$ )	Rated current ※) [mA]		Measuring frequency [kHz]
						Saturation current Idc1	Temperature rise current Idc2	
NRS4012T 1R0NDGG	RoHS	1.0	$\pm 30\%$	100	0.042	2,800	2,200	100
NRS4012T 2R2MDGJ	RoHS	2.2		70	0.060	1,650	1,900	
NRS4012T 3R3MDGJ	RoHS	3.3	$\pm 20\%$	60	0.070	1,400	1,700	
NRS4012T 4R7MDGJ	RoHS	4.7		45	0.095	1,200	1,500	
NRS4012T 6R8MDGJ	RoHS	6.8		35	0.125	900	1,300	
NRS4012T 100MDGJ	RoHS	10		30	0.170	800	1,100	
NRS4012T 150MDGJ	RoHS	15		24	0.260	650	750	
NRS4012T 220MDGJ	RoHS	22		18	0.400	500	620	

● **NRS4018 Shielded type**

Ordering code	EHS (Environmental Hazardous Substances)	Inductance [ $\mu$ H]	Inductance Tolerance	Self-resonant frequency [MHz] (min.)	DC Resistance [ $\Omega$ ] ( $\pm 20\%$ )	Rated current ※) [mA]		Measuring frequency [kHz]
						Saturation current Idc1	Temperature rise current Idc2	
NRS4018T 1R0NDGJ	RoHS	1.0	$\pm 30\%$	90	0.027	4,000	3,200	100
NRS4018T 2R2MDGJ	RoHS	2.2		60	0.042	3,000	2,200	
NRS4018T 3R3MDGJ	RoHS	3.3	$\pm 20\%$	45	0.055	2,300	2,000	
NRS4018T 4R7MDGJ	RoHS	4.7		35	0.070	2,000	1,700	
NRS4018T 6R8MDGJ	RoHS	6.8		30	0.098	1,600	1,450	
NRS4018T 100MDGJ	RoHS	10		25	0.150	1,300	1,200	
NRS4018T 150MDGJ	RoHS	15		18	0.210	1,100	850	
NRS4018T 220MDGJ	RoHS	22		15	0.290	900	720	
NRS4018T 330MDGJ	RoHS	33	12	0.460	700	550		

● **NRS5012 Type**

Ordering code	EHS (Environmental Hazardous Substances)	Inductance [ $\mu$ H]	Inductance Tolerance	Self-resonant frequency [MHz] (min.)	DC Resistance [ $\Omega$ ] ( $\pm 20\%$ )	Rated current ※) [mA]		Measuring frequency [kHz]
						Saturation current Idc1	Temperature rise current Idc2	
NRS5012T 1R0NMGF	RoHS	1.0	$\pm 30\%$	100	0.053	4,500	2,300	100
NRS5012T 1R5NMGF	RoHS	1.5		86	0.070	3,800	2,200	
NRS5012T 2R2MMGF	RoHS	2.2	$\pm 20\%$	70	0.085	3,100	2,000	
NRS5012T 3R3MMGF	RoHS	3.3		48	0.160	2,400	1,450	
NRS5012T 4R7MMGF	RoHS	4.7		40	0.180	2,200	1,400	
NRS5012T 6R8MMGF	RoHS	6.8		36	0.260	1,700	1,100	
NRS5012T 100MMGF	RoHS	10		26	0.420	1,400	850	
NRS5012T 150MMGF	RoHS	15		22	0.670	1,200	640	

● **NRS5014 Shielded type**

Ordering code	EHS (Environmental Hazardous Substances)	Inductance [ $\mu$ H]	Inductance Tolerance	Self-resonant frequency [MHz] (min.)	DC Resistance [ $\Omega$ ] ( $\pm 20\%$ )	Rated current ※) [mA]		Measuring frequency [kHz]
						Saturation current Idc1	Temperature rise current Idc2	
NRS5014T 1R2NMGG	RoHS	1.2	$\pm 30\%$	86	0.045	3,800	2,400	100
NRS5014T 2R2NMGG	RoHS	2.2		56	0.065	2,800	2,000	
NRS5014T 3R3NMGG	RoHS	3.3	$\pm 20\%$	48	0.080	2,350	1,700	
NRS5014T 4R7NMGG	RoHS	4.7		41	0.100	2,050	1,400	
NRS5014T 6R8MMGG	RoHS	6.8		33	0.150	1600	1,200	
NRS5014T 100MMGG	RoHS	10	27	0.200	1400	1,050		

※) The saturation current value (Idc1) is the DC current value having inductance decrease down to 30%. (at 20°C)

※) The temperature rise current value (Idc2) is the DC current value having temperature increase up to 40°C. (at 20°C)

※) The rated current is the DC current value that satisfies both of current value saturation current value and temperature rise current value.

\* This catalog contains the typical specification only due to the limitation of space. When you consider the purchase of our products, please check our specification. For details of each product (characteristics graph, reliability information, precautions for use, and so on), see our Web site (<http://www.ty-top.com/>) or CD catalogs.

**PART NUMBERS**

● **NRS5020 Shielded type**

Ordering code	EHS (Environmental Hazardous Substances)	Inductance [ $\mu$ H]	Inductance Tolerance	Self-resonant frequency (MHz) (min.)	DC Resistance [ $\Omega$ ] ( $\pm 20\%$ )	Rated current ※) (mA)		Measuring frequency (kHz)
						Saturation current Idc1	Temperature rise current Idc2	
NRS5020T 1R0NMGJ	RoHS	1.0	$\pm 30\%$	81	0.021	4,000	3,600	100
NRS5020T 1R5NMGJ	RoHS	1.5		68	0.026	3,350	3,200	
NRS5020T 2R2NMGJ	RoHS	2.2		57	0.035	2,900	2,900	
NRS5020T 3R3NMGJ	RoHS	3.3		46	0.048	2,400	2,400	
NRS5020T 4R7MMGJ	RoHS	4.7		37	0.060	2,000	2,000	
NRS5020T 6R8MMGJ	RoHS	6.8	$\pm 20\%$	30	0.090	1,600	1,650	
NRS5020T 100MMGJ	RoHS	10		24	0.120	1,300	1,450	
NRS5020T 150MMGJ	RoHS	15		20	0.165	1,100	1,200	
NRS5020T 220MMGJ	RoHS	22		17	0.260	900	1,000	

● **NRS6010 Type**

Ordering code	EHS (Environmental Hazardous Substances)	Inductance [ $\mu$ H]	Inductance Tolerance	Self-resonant frequency (MHz) (min.)	DC Resistance [ $\Omega$ ] ( $\pm 20\%$ )	Rated current ※) (mA)		Measuring frequency (kHz)
						Saturation current Idc1	Temperature rise current Idc2	
NRS6010T 1R5MMGF	RoHS	1.5	$\pm 20\%$	77	0.090	2,400	1,900	100
NRS6010T 2R2MMGF	RoHS	2.2		56	0.110	1,900	1,700	
NRS6010T 3R3MMGF	RoHS	3.3		42	0.135	1,600	1,500	
NRS6010T 4R7MMGF	RoHS	4.7		36	0.165	1,300	1,400	
NRS6010T 6R8MMGF	RoHS	6.8		30	0.220	1,200	1,200	
NRS6010T 100MMGF	RoHS	10		25	0.270	1,000	1,100	
NRS6010T 220MMGF	RoHS	22		12	0.580	650	700	

● **NRS6012 Shielded type**

Ordering code	EHS (Environmental Hazardous Substances)	Inductance [ $\mu$ H]	Inductance Tolerance	Self-resonant frequency (MHz) (min.)	DC Resistance [ $\Omega$ ] ( $\pm 20\%$ )	Rated current ※) (mA)		Measuring frequency (kHz)
						Saturation current Idc1	Temperature rise current Idc2	
NRS6012T 2R5NMGJ	RoHS	2.5	$\pm 30$	45	0.090	2,100	1,800	100
NRS6012T 3R3NMGJ	RoHS	3.3		42	0.105	1,800	1,700	
NRS6012T 4R7MMGJ	RoHS	4.7		36	0.125	1,600	1,550	
NRS6012T 5R3MMGJ	RoHS	5.3		34	0.125	1,500	1,550	
NRS6012T 6R8MMGJ	RoHS	6.8		30	0.165	1,300	1,350	
NRS6012T 100MMGJ	RoHS	10	$\pm 20$	22	0.200	1,000	1,200	
NRS6012T 150MMGJ	RoHS	15		18	0.295	800	800	
NRS6012T 220MMGJ	RoHS	22		12	0.465	760	650	
NRS6012T 330MMGJ	RoHS	33		8	0.580	590	550	
NRS6012T 470MMGJ	RoHS	47		6	0.965	520	460	
NRS6012T 680MMGJ	RoHS	68		3	1.160	440	410	
NRS6012T 101MMGJ	RoHS	100		1	1.670	350	320	

● **NRS6020 Shielded type**

Ordering code	EHS (Environmental Hazardous Substances)	Inductance [ $\mu$ H]	Inductance Tolerance	Self-resonant frequency (MHz) (min.)	DC Resistance [ $\Omega$ ] ( $\pm 20\%$ )	Rated current ※) (mA)		Measuring frequency (kHz)
						Saturation current Idc1	Temperature rise current Idc2	
NRS6020T 0R8NMGJ	RoHS	0.8	$\pm 30\%$	110	0.020	6,400	4,100	100
NRS6020T 1R5NMGJ	RoHS	1.5		93	0.026	4,300	3,600	
NRS6020T 2R2NMGJ	RoHS	2.2		73	0.034	3,200	2,900	
NRS6020T 3R3NMGJ	RoHS	3.3		55	0.040	2,800	2,750	
NRS6020T 4R7NMGJ	RoHS	4.7		43	0.058	2,400	2,150	
NRS6020T 6R8NMGJ	RoHS	6.8		30	0.085	2,000	1,800	
NRS6020T 100MMGG	RoHS	10	$\pm 20\%$	18	0.125	1,900	1,500	
NRS6020T 220MMGG	RoHS	22		11	0.290	1,250	950	

● **NRS6028 Shielded type**

Ordering code	EHS (Environmental Hazardous Substances)	Inductance [ $\mu$ H]	Inductance Tolerance	Self-resonant frequency (MHz) (min.)	DC Resistance [ $\Omega$ ] ( $\pm 30\%$ )	Rated current ※) (mA)		Measuring frequency (kHz)
						Saturation current Idc1	Temperature rise current Idc2	
NRS6028T 0R9NMGJ	RoHS	0.9	$\pm 30\%$	90	0.013	6,700	4,600	100
NRS6028T 1R5NMGJ	RoHS	1.5		78	0.016	5,100	4,200	
NRS6028T 2R2NMGJ	RoHS	2.2		68	0.020	4,200	3,700	
NRS6028T 3R0NMGJ	RoHS	3.0		55	0.023	3,600	3,400	
NRS6028T 4R7MMGK	RoHS	4.7		39	0.031	2,700	3,000	
NRS6028T 6R0MMGK	RoHS	6.0		30	0.040	2,500	2,500	
NRS6028T 100MMGK	RoHS	10	$\pm 20\%$	20	0.065	1,900	1,900	
NRS6028T 150MMGJ	RoHS	15		17	0.095	1,600	1,800	
NRS6028T 220MMGJ	RoHS	22		12	0.135	1,300	1,400	
NRS6028T 330MMGJ	RoHS	33		10	0.220	1,100	1,100	
NRS6028T 470MMGJ	RoHS	47		8	0.300	1,000	920	
NRS6028T 680MMGJ	RoHS	68		5	0.420	800	770	
NRS6028T 101MMGJ	RoHS	100		3	0.600	650	660	

※) The saturation current value (Idc1) is the DC current value having inductance decrease down to 30%. (at 20°C)

※) The temperature rise current value (Idc2) is the DC current value having temperature increase up to 40°C. (at 20°C)

※) The rated current is the DC current value that satisfies both of current value saturation current value and temperature rise current value.

\* This catalog contains the typical specification only due to the limitation of space. When you consider the purchase of our products, please check our specification. For details of each product (characteristics graph, reliability information, precautions for use, and so on), see our Web site (<http://www.ty-top.com/>) or CD catalogs.

## PART NUMBERS

### ● NRS6045 Shielded type

Ordering code	EHS (Environmental Hazardous Substances)	Inductance [ $\mu$ H]	Inductance Tolerance	Self-resonant frequency (MHz) (min.)	DC Resistance [ $\Omega$ ] ( $\pm$ 30%)	Rated current ※) [mA]		Measuring frequency (kHz)
						Saturation current Idc1	Temperature rise current Idc2	
NRS6045T 1R0NMGK	RoHS	1.0	$\pm$ 30%	110	0.014	9,800	4,500	100
NRS6045T 1R3NMGK	RoHS	1.3		95	0.016	8,200	4,200	
NRS6045T 1R8NMGK	RoHS	1.8		80	0.019	7,200	3,900	
NRS6045T 2R3NMGK	RoHS	2.3		60	0.022	6,400	3,600	
NRS6045T 3R0NMGK	RoHS	3.0		45	0.024	5,600	3,300	
NRS6045T 4R5MMGK	RoHS	4.5		25	0.030	4,400	3,100	
NRS6045T 6R3MMGK	RoHS	6.3		15	0.036	3,600	3,000	
NRS6045T 100MMGK	RoHS	10	$\pm$ 20%	12	0.046	3,100	2,400	
NRS6045T 150MMGK	RoHS	15		10	0.070	2,500	1,900	
NRS6045T 220MMGK	RoHS	22		7	0.107	2,000	1,600	
NRS6045T 330MMGK	RoHS	33		6	0.141	1,650	1,400	
NRS6045T 470MMGK	RoHS	47		5	0.211	1,400	1,150	
NRS6045T 680MMGK	RoHS	68		4	0.304	1,100	950	
NRS6045T 101MMGK	RoHS	100		3	0.466	900	750	

### ● NRS8030 Shielded type

Ordering code	EHS (Environmental Hazardous Substances)	Inductance [ $\mu$ H]	Inductance Tolerance	Self-resonant frequency (MHz) (min.)	DC Resistance [ $\Omega$ ] ( $\pm$ 30%)	Rated current ※) [mA]		Measuring frequency (kHz)
						Saturation current Idc1	Temperature rise current Idc2	
NRS8030T 1R0NJGJ	RoHS	1.0	$\pm$ 30%	120	0.009	7,800	6,200	100
NRS8030T 1R5NJGJ	RoHS	1.5		80	0.012	6,200	5,300	
NRS8030T 2R2NJGJ	RoHS	2.2		60	0.015	4,900	4,800	
NRS8030T 3R3MJGJ	RoHS	3.3		50	0.019	4,200	4,300	
NRS8030T 4R7MJGJ	RoHS	4.7		40	0.022	3,600	4,000	
NRS8030T 6R8MJGJ	RoHS	6.8	$\pm$ 20%	32	0.029	3,000	3,400	
NRS8030T 100MJGJ	RoHS	10		27	0.033	2,400	3,000	
NRS8030T 150MJGJ	RoHS	15		20	0.060	2,000	2,200	
NRS8030T 220MJGJ	RoHS	22		16	0.070	1,750	1,900	
NRS8030T 330MJGJ	RoHS	33		13	0.120	1,300	1,500	
NRS8030T 470MJGJ	RoHS	47		11	0.170	1,100	1,300	

### ● NRS8040 Shielded type

Ordering code	EHS (Environmental Hazardous Substances)	Inductance [ $\mu$ H]	Inductance Tolerance	Self-resonant frequency (MHz) (min.)	DC Resistance [ $\Omega$ ] ( $\pm$ 30%)	Rated current ※) [mA]		Measuring frequency (kHz)
						Saturation current Idc1	Temperature rise current Idc2	
NRS8040T 0R9NJGJ	RoHS	0.9	$\pm$ 30%	85	0.006	13,000	7,800	100
NRS8040T 1R4NJGJ	RoHS	1.4		63	0.007	10,000	7,000	
NRS8040T 2R0NJGJ	RoHS	2.0		50	0.009	8,100	6,300	
NRS8040T 3R6NJGJ	RoHS	3.6		34	0.015	6,400	4,900	
NRS8040T 4R7NJGJ	RoHS	4.7		30	0.018	5,400	4,100	
NRS8040T 6R8NJGJ	RoHS	6.8		24	0.025	4,400	3,700	
NRS8040T 100MJGJ	RoHS	10	$\pm$ 20%	22	0.034	3,800	3,100	
NRS8040T 150MJGJ	RoHS	15		16	0.050	2,900	2,400	
NRS8040T 220MJGJ	RoHS	22		13	0.066	2,400	2,200	

※) The saturation current value (Idc1) is the DC current value having inductance decrease down to 30%. (at 20°C)

※) The temperature rise current value (Idc2) is the DC current value having temperature increase up to 40°C. (at 20°C)

※) The rated current is the DC current value that satisfies both of current value saturation current value and temperature rise current value.



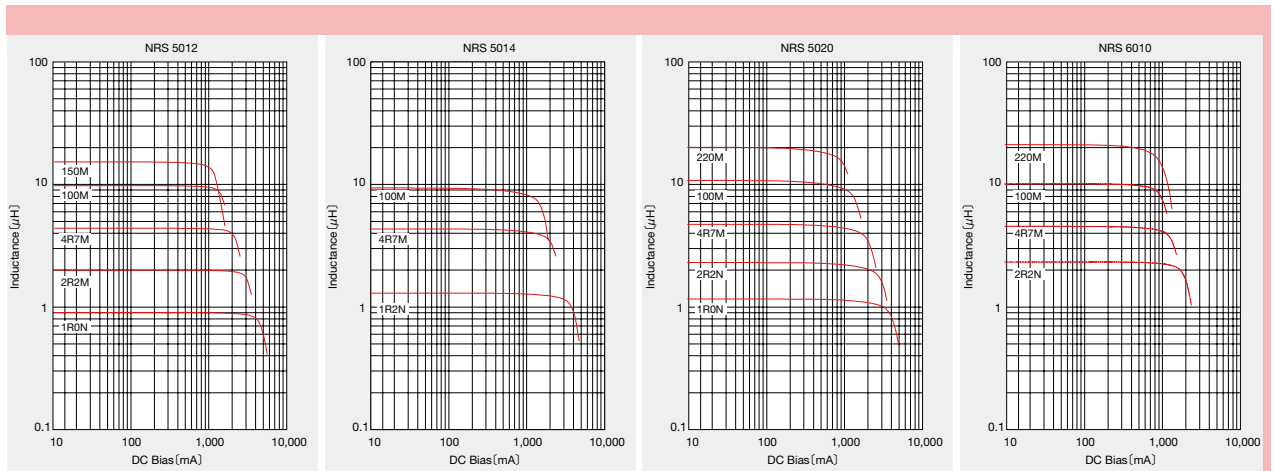
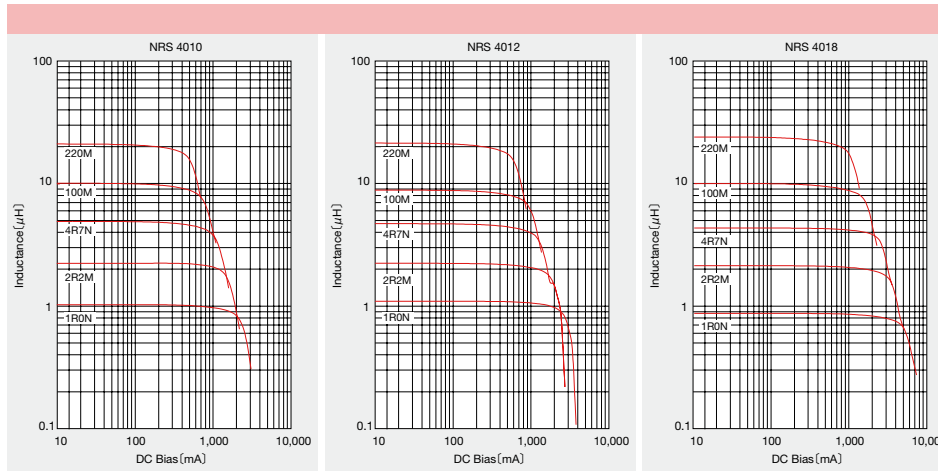
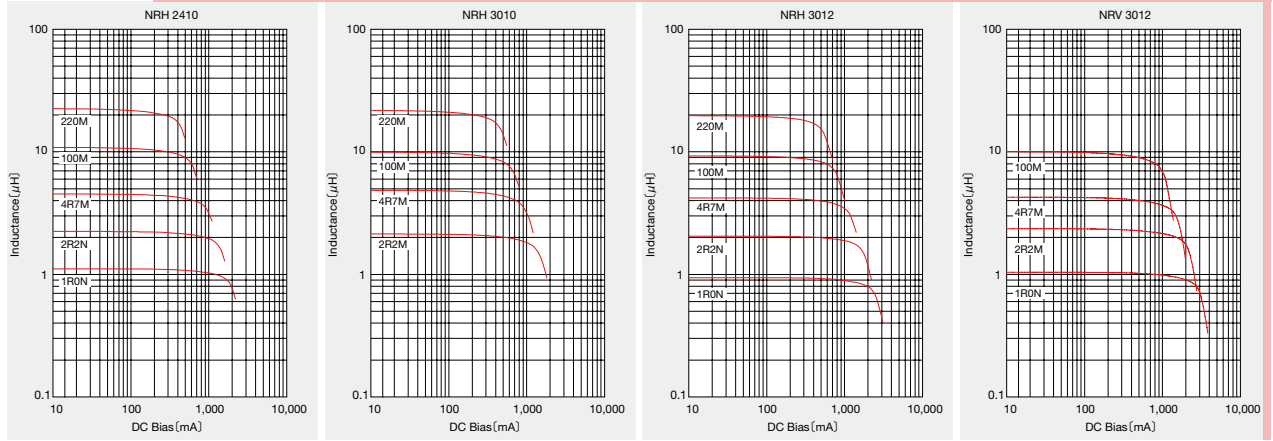

FERRITE PRODUCTS

\* This catalog contains the typical specification only due to the limitation of space. When you consider the purchase of our products, please check our specification. For details of each product (characteristics graph, reliability information, precautions for use, and so on), see our Web site (<http://www.ty-top.com/>) or CD catalogs.

DC Bias characteristics

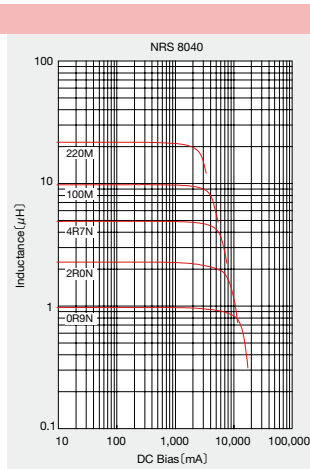
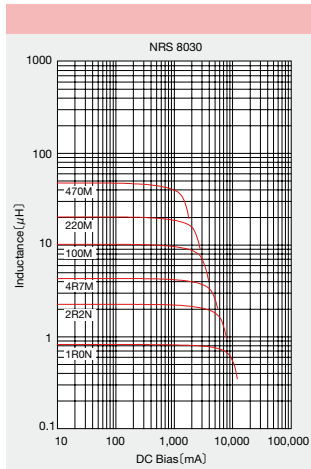
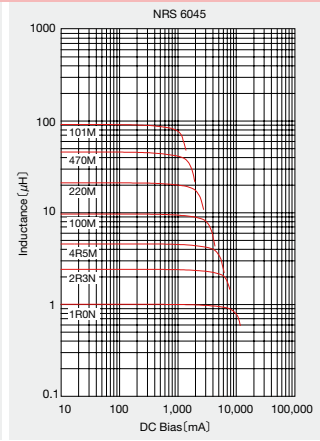
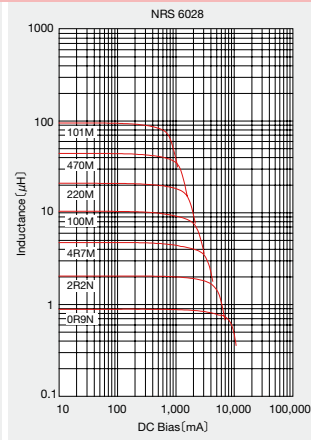
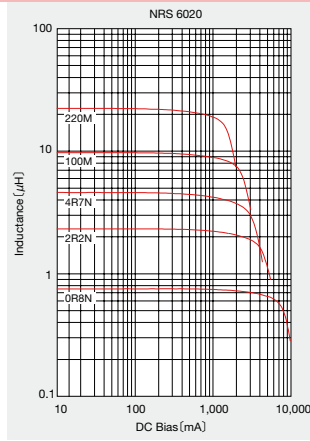
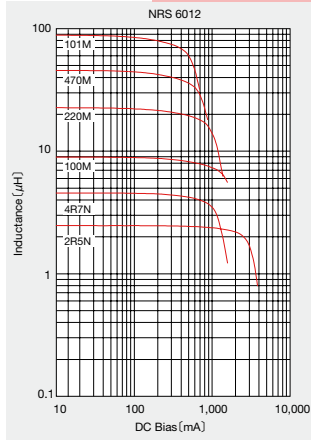

\* This catalog contains the typical specification only due to the limitation of space. When you consider the purchase of our products, please check our specification. For details of each product (characteristics graph, reliability information, precautions for use, and so on), see our Web site (<http://www.ty-top.com/>) or CD catalogs.

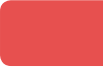

---

\* This catalog contains the typical specification only due to the limitation of space. When you consider the purchase of our products, please check our specification.  
For details of each product (characteristics graph, reliability information, precautions for use, and so on), see our Web site (<http://www.ty-top.com/>) or CD catalogs.

# PACKAGING

## ① Minimum Quantity

Type	Standard Quantity [pcs]
	Tape & Reel
NRH2410	2500
NR 3010/NRH3010	2000
NR 3012/NRH3012/NRV3012	2000
NR 3015	2000
NR 4010/NRS4010	5000
NR 4012/NRS4012	4500
NR 4018/NRS4018	3500
NRG4026	2000
NRS5012	1000
NRS5014	1000
NRS5020	800
NR 5040	1500
NRS6010	1000
NR 6012/NRS6012	1000
NR 6020/NRS6020	2500
NR 6028/NRS6028	2000
NR 6045/NRS6045	1500
NRS8030	1000
NR 8040/NRS8040	1000

## ② Tape Material

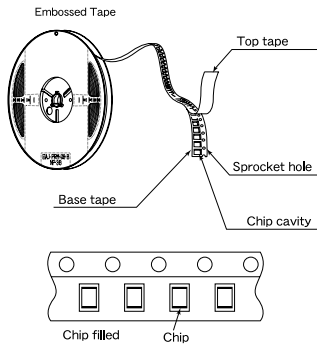

## ③ Taping dimensions

### ● Embossed tape 8mm wide (0.315 inches wide)

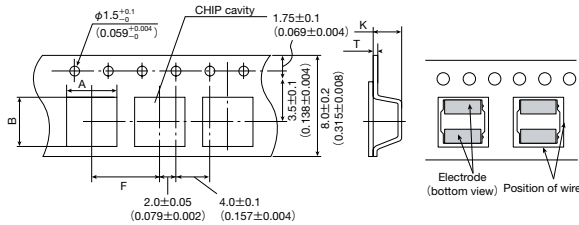

Type	Chip cavity		Insertion pitch F	Tape thickness	
	A	B		T	K
NRH 2410	2.6±0.1 (0.102±0.004)	2.6±0.1 (0.102±0.004)	4.0±0.1 (0.157±0.004)	0.25±0.05 (0.009±0.002)	1.3±0.1 (0.051±0.004)
NR 3010 NRH 3010				1.4±0.1 (0.055±0.004)	
NR 3012 NRH 3012 NRV3012	3.2±0.1 (0.126±0.004)	3.2±0.1 (0.126±0.004)	0.3±0.05 (0.012±0.002)	1.4±0.1 (0.063±0.004)	
NR 3015				1.9±0.1 (0.075±0.004)	

Unit : mm (inch)

### ● Embossed tape 12mm wide (0.47 inches wide)

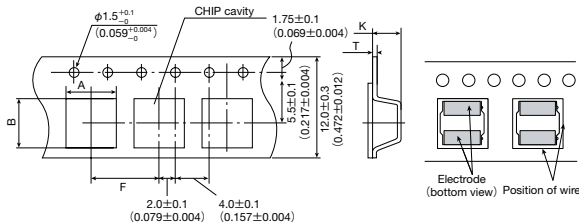

Type	Chip cavity		Insertion pitch F	Tape thickness	
	A	B		T	K
NR 4010 NRS 4010	4.3±0.1 (0.169±0.004)	4.3±0.1 (0.169±0.004)	8.0±0.1 (0.315±0.004)	0.3±0.05 (0.012±0.002)	1.4±0.1 (0.055±0.004)
NR 4012 NRS 4012					1.6±0.1 (0.063±0.004)
NR 4018 NRS 4018					2.1±0.1 (0.083±0.004)
NRG 4026					3.1±0.1 (0.122±0.004)
NRS 5012	5.25±0.1 (0.207±0.004)	5.25±0.1 (0.207±0.004)	8.0±0.1 (0.315±0.004)	0.4±0.1 (0.016±0.004)	1.4±0.1 (0.055±0.004)
NRS 5014					1.6±0.1 (0.063±0.004)
NRS 5020	5.15±0.1 (0.203±0.004)	5.15±0.1 (0.203±0.004)	8.0±0.1 (0.315±0.004)	0.4±0.1 (0.016±0.004)	2.3±0.1 (0.091±0.004)
NR 5040					4.2±0.1 (0.165±0.004)
NR 6010	6.3±0.1 (0.248±0.004)	6.3±0.1 (0.248±0.004)	8.0±0.1 (0.315±0.004)	0.4±0.1 (0.016±0.004)	1.4±0.1 (0.055±0.004)
NR 6012 NRS 6012					1.6±0.1 (0.063±0.004)
NR 6020 NRS 6020					2.3±0.1 (0.090±0.004)
NR 6028 NRS 6028					3.1±0.1 (0.122±0.004)
NR 6045 NRS 6045					4.7±0.1 (0.185±0.004)

Unit : mm (inch)

### ● Embossed tape 16mm wide (0.63 inches wide)

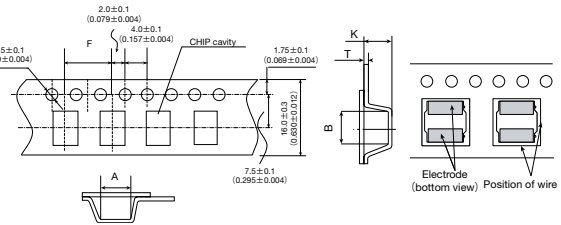

Type	Chip cavity		Insertion pitch F	Tape thickness	
	A	B		T	K
NRS 8030	8.3±0.1 (0.327±0.004)	8.3±0.1 (0.327±0.004)	12.0±0.1 (0.472±0.004)	0.5±0.1 (0.020±0.004)	3.4±0.1 (0.134±0.004)
NR 8040 NRS 8040					4.5±0.1 (0.177±0.004)

Unit : mm (inch)

## ④ Leader and Blank portion

### ● NR, NRH, NRS, NRG, NRV

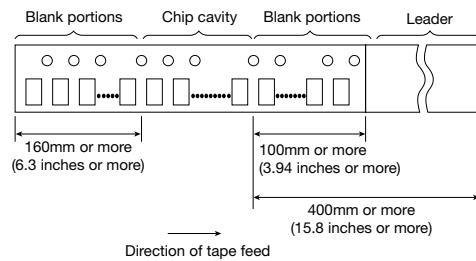

\* This catalog contains the typical specification only due to the limitation of space. When you consider the purchase of our products, please check our specification. For details of each product (characteristics graph, reliability information, precautions for use, and so on), see our Web site (<http://www.ty-top.com/>) or CD catalogs.

⑤ Reel size

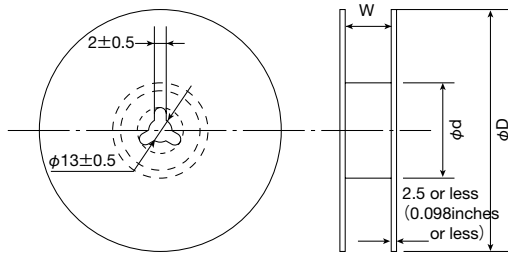

Type	Reel size (Reference values)		
	$\phi D$	$\phi d$	W
NRH2410	180±0.5 (7.087±0.019)	60±1.0 (2.36±0.04)	10.0±1.5 (0.394±0.059)
NR 3010			
NRH 3010			
NR 3012			
NRH 3012			
NRV 3012			
NR 3015	180±3.0 (7.087±0.118)	60±2.0 (2.36±0.08)	14.0±1.5 (0.551±0.059)
NRS 5012			
NRS 5014			
NRS 5020			
NRS 6010			
NR 6012 NRS 6012			

Unit : mm (inch)

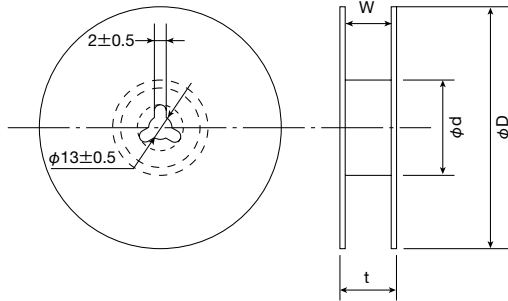

Type	Reel size (Reference values)			
	$\phi D$	$\phi d$	t (max.)	W
NR 4010 NRS 4010	330±3.0 (12.99±0.118)	80±2.0 (3.15±0.078)	18.5 (0.72)	13.5±1.0 (0.531±0.04)
NR 4012 NRS 4012				
NR 4018 NRS 4018				
NRG 4026				
NR 5040				
NR 6020 NRS 6020				
NR 6028 NRS 6028				
NR 6045 NRS 6045				
NRS 8030				
NR 8040 NRS 8040				
			22.5 (0.89)	17.5±1.0 (0.689±0.04)

Unit : mm (inch)

⑥ Top Tape Strength

The top tape requires a peel-off force of 0.1 to 1.3N in the direction of the arrow as illustrated below.

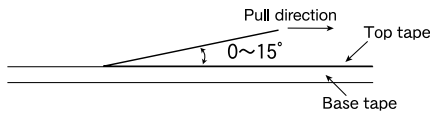

\* This catalog contains the typical specification only due to the limitation of space. When you consider the purchase of our products, please check our specification. For details of each product (characteristics graph, reliability information, precautions for use, and so on), see our Web site (<http://www.ty-top.com/>) or CD catalogs.

# SMD INDUCTORS LARGE CURRENT TYPE



REFLOW

## FEATURES

- SMD inductor.
- It corresponds to High current.
- Simple and original magnetic shield structure.

## APPLICATIONS

- Power supply circuits / DC-DC converters in a variety of applications such as PDP TV, LCD TV, HDD, PC, etc.

## OPERATING TEMPERATURE RANGE

- -25°C~105°C (Including self-generated heat)

## ORDERING CODE

N R △ 1 0 0 5 0 T △ 1 0 0 M △

<b>1</b> Type	<b>2</b> External dimensions (W×H)	<b>3</b> Packaging	<b>4</b> Nominal inductance (μH)	<b>5</b> Inductance tolerance	<b>6</b> Internal code
NR△ Coating resin specification △=Blank Space	example 10050 10.0×5.0mm	T△ Tape & Reel △=Blank Space	example 1R3 1.3 100 10 101 100 ※R=decimal point	M ±20% N ±30%	△ Standard product △=Blank Space

## EXTERNAL DIMENSIONS/STANDARD QUANTITY

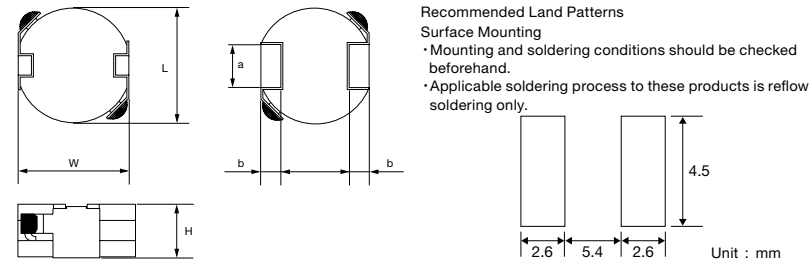

Type	L	W	H	a	b	Standard Quantity [pcs] Tape & Reel
NR 10050	10.0±0.3 (0.394±0.012)	9.8±0.5 (0.386±0.020)	5.0 max (0.197 max)	4.0 (0.16)	1.75 (0.07)	500

Unit : mm (inch)

## AVAILABLE INDUCTANCE RANGE

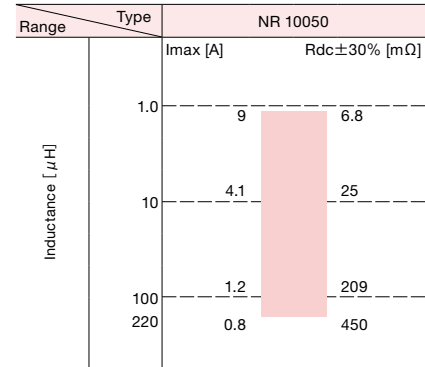

## PART NUMBERS

### NR 10050 type

Ordering code	EHS (Environmental Hazardous Substances)	Inductance [μH]	Inductance Tolerance	Self-resonant frequency [MHz] (min.)	DC Resistance [Ω] (±30%)	Rated current ※) [mA]		Measuring frequency [kHz]
						Saturation current ldc1	Temperature rise current ldc2	
NR10050T1R3N	RoHS	1.3	±30%	53	0.0068	11000	9000	100
NR10050T2R1N	RoHS	2.1		37	0.008	10000	8300	
NR10050T2R9N	RoHS	2.9		29	0.0093	8200	7300	
NR10050T3R8N	RoHS	3.8		26	0.013	7300	6800	
NR10050T4R9N	RoHS	4.9		23	0.015	6600	6000	
NR10050T6R5N	RoHS	6.5		19	0.018	6000	5200	
NR10050T100M	RoHS	10	±20%	15	0.025	4700	4100	
NR10050T150M	RoHS	15		11	0.035	3600	3200	
NR10050T220M	RoHS	22		10	0.045	2600	2500	
NR10050T330M	RoHS	33		8.2	0.066	2500	2100	
NR10050T470M	RoHS	47		7.0	0.092	2000	1800	
NR10050T680M	RoHS	68		5.6	0.144	1700	1500	
NR10050T101M	RoHS	100		4.6	0.209	1300	1200	
NR10050T221M	RoHS	220		3.0	0.450	1000	800	

※) The saturation current value (ldc1) is the DC current value having inductance decrease down to 30%. (at 20°C)

※) The temperature rise current value (ldc2) is the DC current value having temperature increase up to 40°C. (at 20°C)

※) The maximum rated current is the DC current value that satisfies both of current value Saturation current value and temperature rise current value. (at 20°C)

\* This catalog contains the typical specification only due to the limitation of space. When you consider the purchase of our products, please check our specification. For details of each product (characteristics graph, reliability information, precautions for use, and so on), see our Web site (<http://www.ty-top.com/>) or CD catalogs.

DC Bias characteristics (Measured by HP4285A)

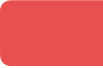
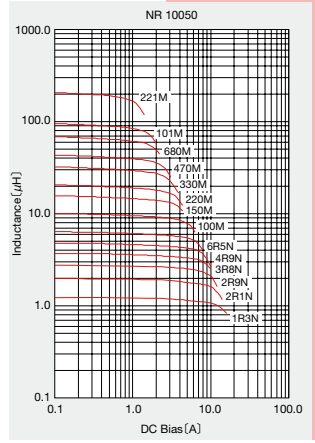

\* This catalog contains the typical specification only due to the limitation of space. When you consider the purchase of our products, please check our specification. For details of each product (characteristics graph, reliability information, precautions for use, and so on), see our Web site (<http://www.ty-top.com/>) or CD catalogs.

## PACKAGING

### ① Minimum Quantity

Type	Standard Quantity [pcs]
	Tape & Reel
NR 10050	500

### ② Tape Material

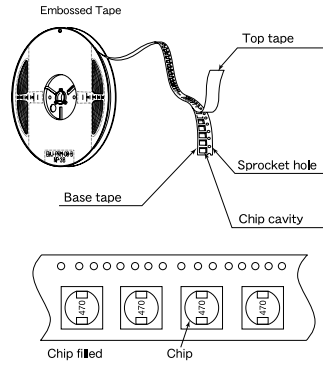

### ③ Taping dimensions

- Embossed tape 24mm wide (0.945 inches wide)

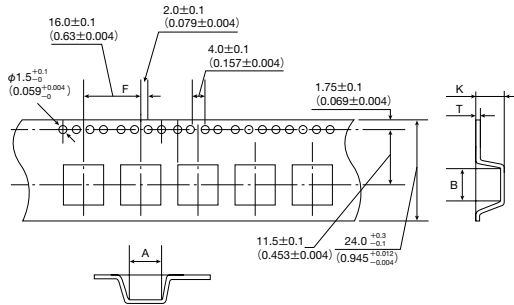

Type	Chip cavity		Insertion pitch	Tape thickness	
	A	B	F	T	K
NR 10050	$10.4 \pm 0.1$ ( $0.409 \pm 0.004$ )	$9.9 \pm 0.1$ ( $0.390 \pm 0.004$ )	$16.0 \pm 0.1$ ( $0.630 \pm 0.004$ )	$0.5 \pm 0.05$ ( $0.020 \pm 0.002$ )	$5.7 \pm 0.1$ ( $0.224 \pm 0.004$ )

Unit : mm (inch)

### ④ Leader and Blank portion

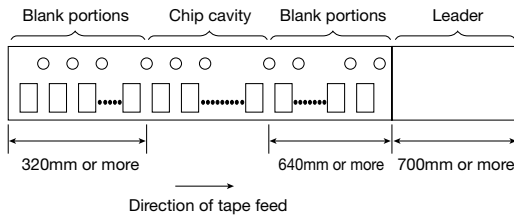

### ⑤ Reel size

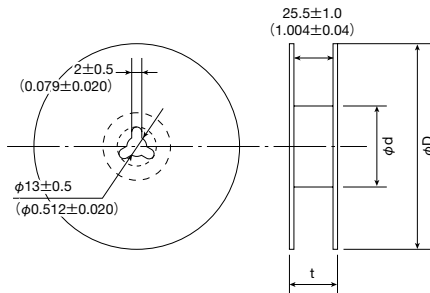

Type	Reel size (Reference values)		
	$\phi D$	$\phi d$	t (max.)
NR 10050	$330 \pm 3$ ( $12.99 \pm 0.118$ )	$80 \pm 2$ ( $3.15 \pm 0.078$ )	$30.5$ ( $1.201$ )

Unit : mm (inch)

### ⑥ Top Tape Strength

The top tape requires a peel-off force of 0.1 to 1.3N in the direction of the arrow as illustrated below.

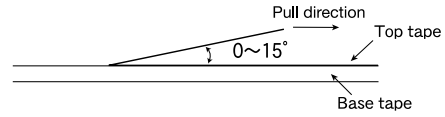

\* This catalog contains the typical specification only due to the limitation of space. When you consider the purchase of our products, please check our specification. For details of each product (characteristics graph, reliability information, precautions for use, and so on), see our Web site (<http://www.ty-top.com/>) or CD catalogs.



# SMD INDUCTORS LARGE CURRENT SHIELD TYPE



REFLOW

## FEATURES

- SMD inductor.
- Low Rdc and high current
- Magnetic shield structure

## APPLICATIONS

- Power supply circuits / DC-DC converters in a variety of applications such as PDP TV, LCD TV, HDD, PC, etc.

## OPERATING TEMPERATURE RANGE

- -40°C~125°C (Including self-generated heat)

## ORDERING CODE

N S  $\triangle$  1 2 5 5 5 T  $\triangle$  1 R 2 M N

① Type		② External Dimensions (W×L×H)			③ Packaging		④ Nominal Inductance (μH)		⑤ Inductance Tolerance		⑥ Internal code	
NS $\triangle$	SMD Inductors	12555	12.5×12.5×5.5mm	T $\triangle$	Tape & Reel	Ex.		M	±20%	N	Marking	
		12565	12.5×12.5×6.5mm			R20	0.2	N	±30%			
		12575	12.5×12.5×7.5mm			1R0	1					
						100	10					
						101	100					

※R=decimal point

## EXTERNAL DIMENSIONS/STANDARD QUANTITY

Recommended Land Patterns  
Surface Mounting  
· Mounting and soldering conditions should be checked beforehand.  
· Applicable soldering process to these products is reflow soldering only.

Unit : mm

Type	L	W	H	a	b	Standard Quantity [pcs] Tape & Reel
NS12555	12.5±0.3 (0.492±0.012)	12.5±0.3 (0.492±0.012)	5.5±0.35 (0.217±0.014)	3.0±0.1 (0.118±0.004)	2.0±0.15 (0.079±0.006)	500
NS12565	12.5±0.3 (0.492±0.012)	12.5±0.3 (0.492±0.012)	6.5±0.35 (0.256±0.014)	3.0±0.1 (0.118±0.004)	2.0±0.15 (0.079±0.006)	
NS12575	12.5±0.3 (0.492±0.012)	12.5±0.3 (0.492±0.012)	7.5±0.35 (0.295±0.014)	3.0±0.1 (0.118±0.004)	2.0±0.15 (0.079±0.006)	

Unit : mm (inch)

## AVAILABLE INDUCTANCE RANGE

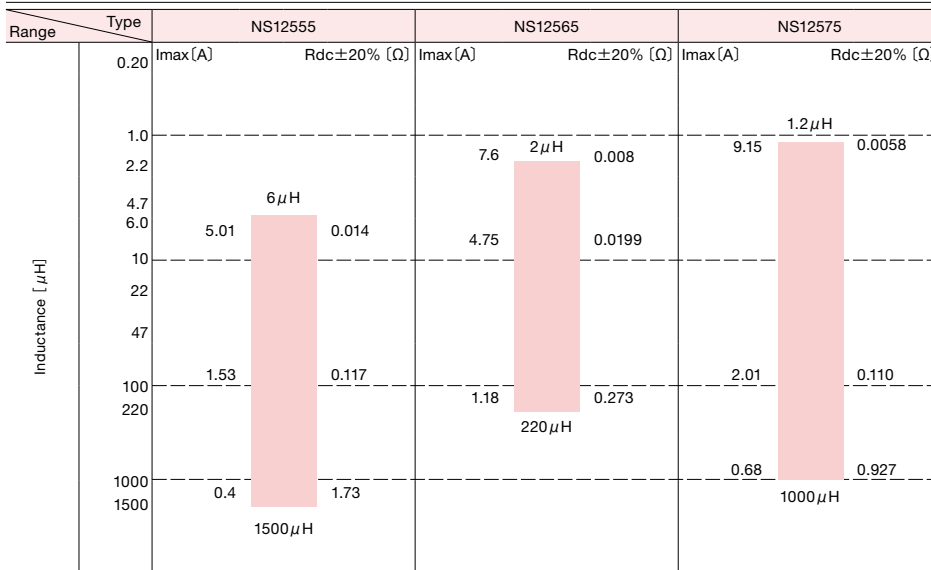

\* This catalog contains the typical specification only due to the limitation of space. When you consider the purchase of our products, please check our specification. For details of each product (characteristics graph, reliability information, precautions for use, and so on), see our Web site (<http://www.ty-top.com/>) or CD catalogs.



## PACKAGING

### ① Packing Quantity

Type	Standard Quantity [pcs]	
	Paper Tape	Embossed Tape
NS12555	—	500
NS12565	—	500
NS12575	—	500

### ② Tape Material

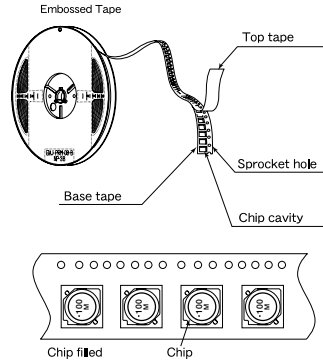

### ③ Taping dimensions

- Embossed tape 24mm wide (0.945 inches wide)

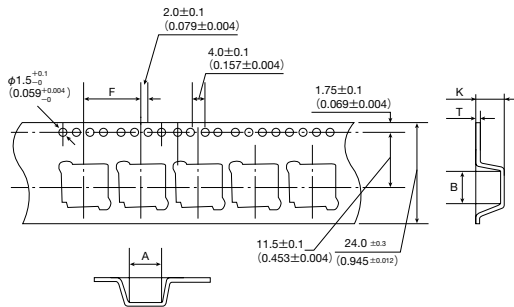

Type	Chip cavity		Insertion pitch	Tape thickness	
	A	B	F	T	K
NS12555	$13.0 \pm 0.1$ ( $0.512 \pm 0.004$ )	$13.0 \pm 0.1$ ( $0.512 \pm 0.004$ )	$16.0 \pm 0.1$ ( $0.630 \pm 0.004$ )	$0.4 \pm 0.1$ ( $0.016 \pm 0.004$ )	$6.1 \pm 0.1$ ( $0.240 \pm 0.004$ )
NS12565	$13.0 \pm 0.1$ ( $0.512 \pm 0.004$ )	$13.0 \pm 0.1$ ( $0.512 \pm 0.004$ )	$16.0 \pm 0.1$ ( $0.630 \pm 0.004$ )	$0.4 \pm 0.1$ ( $0.016 \pm 0.004$ )	$7.1 \pm 0.1$ ( $0.280 \pm 0.004$ )
NS12575	$13.0 \pm 0.1$ ( $0.512 \pm 0.004$ )	$13.0 \pm 0.1$ ( $0.512 \pm 0.004$ )	$16.0 \pm 0.1$ ( $0.630 \pm 0.004$ )	$0.4 \pm 0.1$ ( $0.016 \pm 0.004$ )	$8.0 \pm 0.1$ ( $0.315 \pm 0.004$ )

Unit : mm (inch)

### ④ Leader and Blank portion

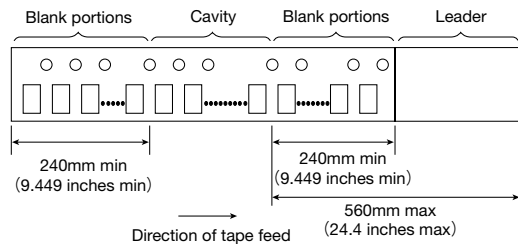

### ⑤ Reel size

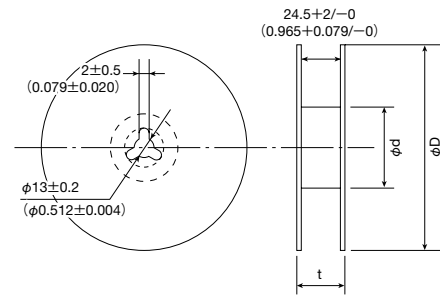

Type	Reel size (Reference values)		
	$\phi D$	$\phi d$	t (max.)
NS12555/ NS12565/ NS12575	$330 \pm 2$ ( $12.99 \pm 0.079$ )	$100 \pm 1$ ( $3.937 \pm 0.039$ )	30.5 (1.201)

Unit : mm (inch)

### ⑥ Top Tape Strength

The top tape requires a peel-off force of 0.1 to 1.3N in the direction of the arrow as illustrated below.

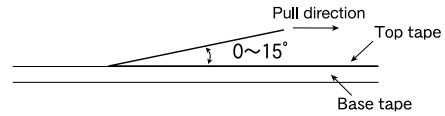

\* This catalog contains the typical specification only due to the limitation of space. When you consider the purchase of our products, please check our specification. For details of each product (characteristics graph, reliability information, precautions for use, and so on), see our Web site (<http://www.ty-top.com/>) or CD catalogs.

## RELIABILITY DATA

### Wound Chip power inductor (NR, NS-series)

<b>1. Operating Temperature Range</b>						
NR30/40/50/60/80, NRV30, NRH24/30, NRS40/50/60/80 Type	-25~+120°C					
NR10050 Type	-25~+105°C					
NS12555, NS12565, NS12575Type	-40~+125°C					
【Test Method and Remarks】 Including self-generated heat						
<b>2. Storage Temperature Range</b>						
NR30/40/50/60/80, NRV30, NRH24/30, NRS40/50/60/80 Type	-40~+85°C					
NR10050 Type						
NS12555, NS12565, NS12575Type						
【Test Method and Remarks】 NR30/40/50/60/80, NRV30, NRH24/30, NRS40/50/60/80 Type, NR10050 Type, NS12555, NS12565, NS12575Type : -5 to 40°C for the product with taping.						
<b>3. Rated current</b>						
NR30/40/50/60/80, NRV30, NRH24/30, NRS40/50/60/80 Type	Within the specified tolerance					
NR10050 Type						
NS12555, NS12565, NS12575Type						
<b>4. Inductance</b>						
NR30/40/50/60/80, NRV30, NRH24/30, NRS40/50/60/80 Type	Within the specified tolerance					
NR10050 Type						
NS12555, NS12565, NS12575Type						
【Test Method and Remarks】 LCR Meter : HP 4285A or equivalent, Measuring frequency : Specified frequency NR30/40/50/60/80, NRV30, NRH24/30, NRS40/50/60/80 Type, NS12555, NS12565, NS12575Type : LCR Meter : HP 4285A or equivalent, 100KHz, 1V NR10050 Type : LCR Meter : HP 4263A or equivalent, 100KHz, 1V						
<b>5. DC Resistance</b>						
NR30/40/50/60/80, NRV30, NRH24/30, NRS40/50/60/80 Type	Within the specified tolerance					
NR10050 Type						
NS12555, NS12565, NS12575Type						
【Test Method and Remarks】 DC ohmmeter : HIOKI 3227 or equivalent						
<b>6. Self resonance frequency</b>						
NR30/40/50/60/80, NRV30, NRH24/30, NRS40/50/60/80 Type	Within the specification					
NR10050 Type						
NS12555, NS12565, NS12575Type						
【Test Method and Remarks】 NR30/40/50/60/80, NRV30, NRH24/30, NRS40/50/60/80 Type, NR10050 Type, NS12555, NS12565, NS12575Type : Impedance analyzer/material analyzer : HP4291A or equivalent HP4191A, 4192A or equivalent						
<b>7. Temperature characteristic</b>						
NR30/40/50/60/80, NRV30, NRH24/30, NRS40/50/60/80 Type	Inductance change : Within $\pm 20\%$					
NR10050 Type	Inductance change : Within $\pm 15\%$					
NS12555, NS12565, NS12575Type						
【Test Method and Remarks】 NR30/40/50/60/80, NRV30, NRH24/30, NRS40/50/60/80 Type, NR10050 Type : Measurement of inductance shall be taken at temperature range within -25°C~+85°C. With reference to inductance value at +20°C., change rate shall be calculated. NS12555, NS12565, NS12575Type : Measurement of inductance shall be taken at temperature range within -40°C~+125°C. With reference to inductance value at +20°C., change rate shall be calculated.						
Change of maximum inductance deviation in step 1 to 5						
Temperature at step 1	20°C					
Temperature at step 2	Minimum operating temperature					
Temperature at step 3	20°C (Standard temperature)					
Temperature at step 4	Maximum operating temperature					
Temperature at step 5	20°C					
<b>8. Resistance to flexure of substrate</b>						
NR30/40/50/60/80, NRV30, NRH24/30, NRS40/50/60/80 Type	No damage					
NR10050 Type	No damage					
NS12555, NS12565, NS12575Type						
【Test Method and Remarks】 NR30/40/50/60/80, NRV30, NRH24/30, NRS40/50/60/80 Type, NS12555, NS12565, NS12575Type : The test samples shall be soldered to the test board by the reflow. As illustrated below, apply force in the direction of the arrow indicating until deflection of the test board reaches to 2 mm. Test board size : 100×40×1.0 Test board material : glass epoxy-resin Solder cream thickness : 0.10 (NR30/40, NRS40, NRH24/30, NRV30) 0.15 (NR50/60/80, NRS40/50/60, NS12555, NS12565, NS12575Type)						
Land dimension (NRH24)	Land dimension (NR30, NRH30, NRV30)	Land dimension (NR40, NRS40)	Land dimension (NR50, NRS50)	Land dimension (NR60, NRS60)	Land dimension (NR80)	Land dimension (NS12555/NS12565/NS12575)
0.7	0.8	1.2	1.5	1.6	1.8	2.5
0.75	1.4	1.6	2.1	3.1	3.8	8.6
0.7	0.8	1.2	1.5	1.6	1.8	2.5
2.0	2.7	3.7	4.0	5.7	7.5	3.2
Unit : mm						

\* This catalog contains the typical specification only due to the limitation of space. When you consider the purchase of our products, please check our specification.  
For details of each product (characteristics graph, reliability information, precautions for use, and so on), see our Web site (<http://www.ty-top.com/>) or CD catalogs.

## RELIABILITY DATA

### Wound Chip power inductor (NR, NS-series)

9. Insulation resistance : between wires	
NR30/40/50/60/80, NRV30, NRH24/30, NRS40/50/60/80 Type	
NR10050 Type	
NS12555, NS12565, NS12575Type	

10. Insulation resistance : between wire and core	
NR30/40/50/60/80, NRV30, NRH24/30, NRS40/50/60/80 Type	
NR10050 Type	
NS12555, NS12565, NS12575Type	

11. Withstanding voltage : between wire and core	
NR30/40/50/60/80, NRV30, NRH24/30, NRS40/50/60/80 Type	
NR10050 Type	
NS12555, NS12565, NS12575Type	

12. Adhesion of terminal electrode	
NR30/40/50/60/80, NRV30, NRH24/30, NRS40/50/60/80 Type	Shall not come off PC board
NR10050 Type	
NS12555, NS12565, NS12575Type	

**[Test Method and Remarks]**

NR30/40/50/60/80, NRV30, NRH24/30, NRS40/50/60/80 Type, NS12555, NS12565, NS12575 Type :

The test samples shall be soldered to the test board by the reflow.

- Applied force : 10N to X and Y directions.
- Duration : 5s.
- Solder cream thickness : 0.15mm.

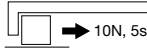

NR10050 Type :

- Applied force : 5N to X and Y directions.
- Duration : 5s.

13. Resistance to vibration	
NR30/40/50/60/80, NRV30, NRH24/30, NRS40/50/60/80 Type	Inductance change : Within $\pm 10\%$ No significant abnormality in appearance.
NR10050 Type	
NS12555, NS12565, NS12575Type	

**[Test Method and Remarks]**

NR30/40/50/60/80, NRV30, NRH24/30, NRS40/50/60/80 Type, NR10050 Type, NS12555, NS12565, NS12575Type :

The test samples shall be soldered to the test board by the reflow.

Then it shall be submitted to below test conditions.

Frequency Range	10~55Hz
Total Amplitude	1.5mm (May not exceed acceleration 196m/s <sup>2</sup> )
Sweeping Method	10Hz to 55Hz to 10Hz for 1min.
Time	X
	Y
	Z
For 2 hours on each X, Y, and Z axis.	

Recovery : At least 2hrs of recovery under the standard condition after the test, followed by the measurement within 48hrs.

14. Solderability	
NR30/40/50/60/80, NRV30, NRH24/30, NRS40/50/60/80 Type	At least 90% of surface of terminal electrode is covered by new solder.
NR10050 Type	
NS12555, NS12565, NS12575Type	

**[Test Method and Remarks]**

The test samples shall be dipped in flux, and then immersed in molten solder as shown in below table.

Flux : Methanol solution containing rosin 25%.

NR30/40/50/60/80, NRV30, NRH24/30, NRS40/50/60/80 Type, NS12555, NS12565, NS12575 Type :

Solder Temperature	245 $\pm 5^{\circ}\text{C}$
Time	5 $\pm 1.0$ sec.

※Immersion depth : All sides of mounting terminal shall be immersed.

15. Resistance to soldering heat	
NR30/40/50/60/80, NRV30, NRH24/30, NRS40/50/60/80 Type	Inductance change : Within $\pm 10\%$ No significant abnormality in appearance.
NR10050 Type	
NS12555, NS12565, NS12575Type	

**[Test Method and Remarks]**

NR30/40/50/60/80, NRV30, NRH24/30, NRS40/50/60/80 Type, NR10050 Type, NS12555, NS12565, NS12575 Type :

The test sample shall be exposed to reflow oven at 230 $\pm 5^{\circ}\text{C}$  for 40 seconds, with peak temperature at 260 $\pm 5^{\circ}\text{C}$  for 5 seconds, 2 times.

NR6020 Type :

The test sample shall be exposed to reflow oven at 230 $\pm 5^{\circ}\text{C}$  for 40 seconds, with peak temperature at 250 $\pm 5^{\circ}\text{C}$  for 5 seconds, 2 times.

Test board thickness : 1.0mm (NR30/40/50/60/80, NRV30, NRH24/30, NRS40/50/60/80 Type, NS12555, NS12565, NS12575 Type)  
1.6mm (NR10050 Type)

Test board material : glass epoxy-resin

\* This catalog contains the typical specification only due to the limitation of space. When you consider the purchase of our products, please check our specification. For details of each product (characteristics graph, reliability information, precautions for use, and so on), see our Web site (<http://www.ty-top.com/>) or CD catalogs.

## RELIABILITY DATA

### Wound Chip power inductor (NR, NS-series)

16. Thermal shock	
NR30/40/50/60/80, NRV30, NRH24/30, NRS40/50/60/80 Type	Inductance change : Within $\pm 10\%$ No significant abnormality in appearance.
NR10050 Type	
NS12555, NS12565, NS12575Type	

#### [Test Method and Remarks]

NR30/40/50/60/80, NRV30, NRH24/30, NRS40/50/60/80 Type, NR10050 Type, NS12555, NS12565, NS12575Type :

The test samples shall be soldered to the test board by the reflow. The test samples shall be placed at specified temperature for specified time by step 1 to step 4 as shown in below table in sequence. The temperature cycle shall be repeated 100 cycles.

Conditions of 1 cycle		
Step	Temperature (°C)	Duration (min)
1	-40 $\pm$ 3	30 $\pm$ 3
2	Room temperature	Within 3
3	+85 $\pm$ 2	30 $\pm$ 3
4	Room temperature	Within 3

17. Damp heat	
NR30/40/50/60/80, NRV30, NRH24/30, NRS40/50/60/80 Type	Inductance change : Within $\pm 10\%$ No significant abnormality in appearance.
NR10050 Type	
NS12555, NS12565, NS12575Type	Inductance change : Within $\pm 10\%$ No significant abnormality in appearance.

#### [Test Method and Remarks]

NR30/40/50/60/80, NRV30, NRH24/30, NRS40/50/60/80 Type, NS12555, NS12565, NS12575Type :

The test samples shall be soldered to the test board by the reflow.

The test samples shall be placed in thermostatic oven set at specified temperature and humidity as shown in below table.

Temperature	60 $\pm$ 2°C
Humidity	90~95%RH
Time	500+24/-0 hour

18. Loading under damp heat	
NR30/40/50/60/80, NRV30, NRH24/30, NRS40/50/60/80 Type	Inductance change : Within $\pm 10\%$ No significant abnormality in appearance.
NR10050 Type	
NS12555, NS12565, NS12575Type	

#### [Test Method and Remarks]

NR30/40/50/60/80, NRV30, NRH24/30, NRS40/50/60/80 Type, NR10050 Type, NS12555, NS12565, NS12575Type :

The test samples shall be soldered to the test board by the reflow.

The test samples shall be placed in thermostatic oven set at specified temperature and humidity and applied the rated current continuously as shown in below table.

Temperature	60 $\pm$ 2°C
Humidity	90~95%RH
Applied current	Rated current
Time	500+24/-0 hour

19. Low temperature life test	
NR30/40/50/60/80, NRV30, NRH24/30, NRS40/50/60/80 Type	Inductance change : Within $\pm 10\%$ No significant abnormality in appearance.
NR10050 Type	
NS12555, NS12565, NS12575Type	

#### [Test Method and Remarks]

NR30/40/50/60/80, NRV30, NRH24/30, NRS40/50/60/80 Type, NR10050 Type, NS12555, NS12565, NS12575Type :

The test samples shall be soldered to the test board by the reflow.

After that, the test samples shall be placed at test conditions as shown in below table.

Temperature	-40 $\pm$ 2°C
Time	500+24/-0 hour

20. High temperature life test	
NR30/40/50/60/80, NRV30, NRH24/30, NRS40/50/60/80 Type	Inductance change : Within $\pm 10\%$ No significant abnormality in appearance.
NR10050 Type	
NS12555, NS12565, NS12575Type	

#### [Test Method and Remarks]

NR10050 Type :

Temperature	105 $\pm$ 3°C
Time	500+24/-0 hour

Recovery : At least 2hrs of recovery under the standard condition after the test, followed by the measurement within 48 hrs.

21. Loading at high temperature life test	
NR30/40/50/60/80, NRV30, NRH24/30, NRS40/50/60/80 Type	Inductance change : Within $\pm 10\%$ No significant abnormality in appearance.
NR10050 Type	
NS12555, NS12565, NS12575Type	Inductance change : Within $\pm 10\%$ No significant abnormality in appearance.

#### [Test Method and Remarks]

NR30/40/50/60/80, NRV30, NRH24/30, NRS40/50/60/80 Type, NS12555, NS12565, NS12575Type :

The test samples shall be soldered to the test board by the reflow soldering.

Temperature	85 $\pm$ 2°C
Applied current	Rated current
Time	500+24/-0 hour

\* This catalog contains the typical specification only due to the limitation of space. When you consider the purchase of our products, please check our specification. For details of each product (characteristics graph, reliability information, precautions for use, and so on), see our Web site (<http://www.ty-top.com/>) or CD catalogs.

■ RELIABILITY DATA

Wound Chip power inductor (NR, NS-series)

22. Standard condition	
NR30/40/50/60/80, NRV30, NRH24/30, NRS40/50/60/80 Type	Standard test condition : Unless otherwise specified, temperature is $20\pm 15^{\circ}\text{C}$ and $65\pm 20\%$ of relative humidity. When there is any question concerning measurement result: In order to provide correlation data, the test shall be condition of $20\pm 2^{\circ}\text{C}$ of temperature, $65\pm 5\%$ relative humidity. Inductance is in accordance with our measured value.
NR10050 Type	
NS12555, NS12565, NS12575 Type	

\* This catalog contains the typical specification only due to the limitation of space. When you consider the purchase of our products, please check our specification.  
For details of each product (characteristics graph, reliability information, precautions for use, and so on), see our Web site (<http://www.ty-top.com/>) or CD catalogs.

## PRECAUTIONS

### Wound Chip power inductor (NR, NS-series)

1. Circuit Design	
Precautions	<ul style="list-style-type: none"> <li>◆ Operating environment</li> <li>1. The products described in this specification are intended for use in general electronic equipment, (office supply equipment, telecommunications systems, measuring equipment, and household equipment). They are not intended for use in mission-critical equipment or systems requiring special quality and high reliability (traffic systems, safety equipment, aerospace systems, nuclear control systems and medical equipment including life-support systems,) where product failure might result in loss of life, injury or damage. For such uses, contact TAIYO YUDEN Sales Department in advance.</li> </ul>
2. PCB Design	
Precautions	<ul style="list-style-type: none"> <li>◆ Land pattern design</li> <li>1. Please refer to a recommended land pattern.</li> </ul>
Technical considerations	<ul style="list-style-type: none"> <li>◆ Land pattern design</li> <li>Surface Mounting</li> <li>• Mounting and soldering conditions should be checked beforehand.</li> <li>• Applicable soldering process to this products is reflow soldering only.</li> </ul>
3. Considerations for automatic placement	
Precautions	<ul style="list-style-type: none"> <li>◆ Adjustment of mounting machine</li> <li>1. Excessive impact load should not be imposed on the products when mounting onto the PC boards.</li> <li>2. Mounting and soldering conditions should be checked beforehand.</li> </ul>
Technical considerations	<ul style="list-style-type: none"> <li>◆ Adjustment of mounting machine</li> <li>1. When installing products, care should be taken not to apply distortion stress as it may deform the products.</li> </ul>
4. Soldering	
Precautions	<ul style="list-style-type: none"> <li>◆ Reflow soldering</li> <li>1. Please contact any of our offices for a reflow soldering, and refer to the recommended condition specified.</li> <li>2. The product shall be used reflow soldering only.</li> <li>3. Please do not add any stress to a product until it returns in normal temperature after reflow soldering.</li> <li>◆ Lead free soldering</li> <li>1. When using products with lead free soldering, we request to use them after confirming adhesion, temperature of resistance to soldering heat, soldering etc sufficiently.</li> <li>◆ Recommended conditions for using a soldering iron (NR10050 Type)</li> <li>• Put the soldering iron on the land-pattern.</li> <li>• Soldering iron's temperature - Below 350°C</li> <li>• Duration - 3 seconds or less</li> <li>• The soldering iron should not directly touch the inductor.</li> </ul>
	<ul style="list-style-type: none"> <li>◆ Reflow soldering</li> <li>1. If products are used beyond the range of the recommended conditions, heat stresses may deform the products, and consequently degrade the reliability of the products.</li> <li>• NR30/40/50/60/80, NRV30, NRH24/30, NRS40/50/60/80 Type, NR10050, NS12555, NS12565, NS12575 Type</li> <li>Recommended reflow condition (Pb free solder)</li> </ul>
Technical considerations	<p>Temperature [°C]</p> <p>Heating Time [sec]</p> <p>150~180</p> <p>90±30sec</p> <p>30±10sec</p> <p>230°C min</p> <p>5sec max</p> <p>Peak: 250+5/-0°C</p>
5. Cleaning	
Precautions	<ul style="list-style-type: none"> <li>◆ Cleaning conditions</li> <li>1. Washing by supersonic waves shall be avoided.</li> </ul>
Technical considerations	<ul style="list-style-type: none"> <li>◆ Cleaning conditions</li> <li>1. If washed by supersonic waves, the products might be broken.</li> </ul>
6. Handling	
Precautions	<ul style="list-style-type: none"> <li>◆ Handling</li> <li>1. Keep the product away from all magnets and magnetic objects.</li> <li>◆ Breakaway PC boards (splitting along perforations)</li> <li>1. When splitting the PC board after mounting product, care should be taken not to give any stresses of deflection or twisting to the board.</li> <li>2. Board separation should not be done manually, but by using the appropriate devices.</li> <li>◆ Mechanical considerations</li> <li>1. Please do not give the product any excessive mechanical shocks.</li> <li>2. Please do not add any shock and power to a product in transportation.</li> <li>◆ Pick-up pressure</li> <li>1. Please do not push to add any pressure to a winding part. Please do not give any shock and push into a ferrite core exposure part.</li> <li>◆ Packing</li> <li>1. Please avoid accumulation of a packing box as much as possible.</li> </ul>
	<ul style="list-style-type: none"> <li>◆ Breakaway PC boards (splitting along perforations)</li> <li>1. The position of the product on PCBs shall be carefully considered to minimize the stress caused from splitting of the PCBs.</li> <li>◆ Mechanical considerations</li> <li>1. There is a case to be damaged by a mechanical shock.</li> <li>2. There is a case to be broken by the handling in transportation.</li> <li>◆ Pick-up pressure</li> <li>1. Damage and a characteristic can vary with an excessive shock or stress.</li> <li>◆ Packing</li> <li>1. If packing boxes are accumulated, that could cause a deformation on packing tapes or a damage on the products.</li> </ul>
Technical considerations	
7. Storage conditions	
Precautions	<ul style="list-style-type: none"> <li>◆ Storage</li> <li>1. To maintain the solderability of terminal electrodes and to keep the packing material in good condition, temperature and humidity in the storage area should be controlled.</li> <li>• Recommended conditions</li> <li>Ambient temperature: -5~40°C</li> <li>Humidity : Below 70% RH</li> <li>The ambient temperature must be kept below 30°C. Even under ideal storage conditions, solderability of products electrodes may decrease as time passes. For this reason, product should be used within 6 months from the time of delivery.</li> <li>In case of storage over 6 months, solderability shall be checked before actual usage.</li> </ul>
Technical considerations	<ul style="list-style-type: none"> <li>◆ Storage</li> <li>1. Under a high temperature and humidity environment, problems such as reduced solderability caused by oxidation of terminal electrodes and deterioration of taping/packaging materials may take place.</li> </ul>

\* This catalog contains the typical specification only due to the limitation of space. When you consider the purchase of our products, please check our specification. For details of each product (characteristics graph, reliability information, precautions for use, and so on), see our Web site (<http://www.ty-top.com/>) or CD catalogs.