

### 4. High Power Type PF, PE, PC, PA, PB, LC, LA



#### ■ Features

- Low DCR and large current capability, suitable for power circuitry.
- Wire wound, resin molded chip inductor. (PC, PA, PB, LC, LA type)
- Unique Ceramic Core/Laser-cut technology (PF, PE type)
- Capable of being Re-flow or flow soldered.
- Wide line-up from 1005 to 4532 case sizes.
- Good for mounting.

#### ■ Recommended Applications

- AV equipment, Wireless communication equipment and various types of general electronic equipment.

#### ■ Explanation of Part Numbers

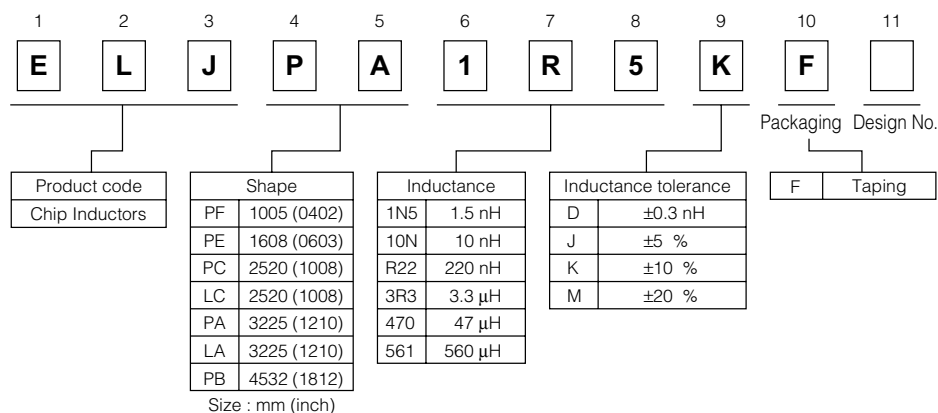

#### ■ Storage Conditions

- Package : Normal temperature (−5 to 35 °C), normal humidity (85 %RH max.), shall not be exposed to direct sunlight and harmful gases and care should be taken so as not to cause dew.
- Operating Temperature : −20 to +85 °C

#### ■ Storage Period

- Solderability may be reduced due to the conditions of high temperature and high humidity which causes the oxidation of tin-plated terminals. Even if storage conditions are within specified limits, solderability may be reduced with the passage of time. Therefore, please control the storage conditions and try to use the product within 6 months of receipt.

■ Packaging Methods                      Please see Page 127

■ Soldering Conditions                      Please see Page 128

■ Safety Precautions                      Please see Page 129

Design and specifications are each subject to change without notice. Ask factory for the current technical specifications before purchase and/or use. Should a safety concern arise regarding this product, please be sure to contact us immediately.

### ■ PF Type 1005 (0402)

● Dimensions in mm (not to scale)

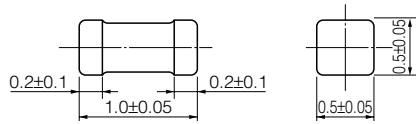

● Recommended Land Pattern in mm (not to scale)

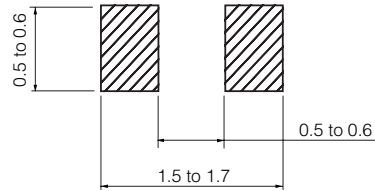

### ■ Standard Packing Quantity

● 10000 pcs./Reel

### ■ Standard Parts

Part No.	Inductance			Q		SRF *1 (MHz) min.	R <sub>DC</sub> *2 (Ω) max.	DC Current (mA) max.
	(nH)	Tolerance (%)	Test Freq. (MHz)	min.	Test Freq. (MHz)			
ELJPF2N2DFB	2.2	D : ±0.3 nH	100	7	100	5300	0.040	1900
ELJPF2N7DFB	2.7					5300	0.050	1800
ELJPF3N3DFB	3.3					5000	0.070	1500
ELJPF3N9DFB	3.9					4800	0.080	1400
ELJPF4N7DFB	4.7					4600	0.100	1300
ELJPF5N6DFB	5.6					4200	0.120	1200
ELJPF6N8JFB	6.8	J : ± 5 %				4000	0.160	1100
ELJPF8N2JFB	8.2					3700	0.210	900
ELJPF10NJFB	10					3200	0.260	750

\*1 : Self Resonant Frequency \*2 : DC Resistance

### ■ PE Type 1608 (0603)

● Dimensions in mm (not to scale)

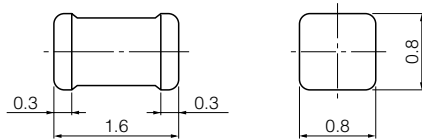

● Recommended Land Pattern in mm (not to scale)

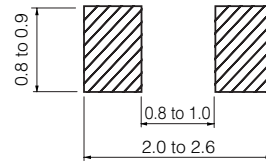

### ■ Standard Packing Quantity

● 3000 pcs./Reel

### ■ Standard Parts (E12 Series)

Part No.	Inductance			Q		SRF *1 (MHz) min.	R <sub>DC</sub> *2 (Ω) max.	DC Current (mA) max.
	(nH)	Tolerance (%)	Test Freq. (MHz)	min.	Test Freq. (MHz)			
ELJPE2N2KFA	2.2	K : ± 10 %	100	8	100	6000	0.030	2100
ELJPE2N7KFA	2.7			8		5500	0.030	2100
ELJPE3N3KFA	3.3			8		5500	0.040	2100
ELJPE3N9KFA	3.9			9		5200	0.040	2100
ELJPE4N7KFA	4.7			9		4800	0.050	2100
ELJPE5N6KFA	5.6			9		4600	0.055	2100
ELJPE6N8KFA	6.8			9		4000	0.055	1900
ELJPE8N2KFA	8.2			9		3500	0.060	1700
ELJPE10NKFA	10			9		2800	0.065	1400
ELJPE12NKFA	12			9		2500	0.080	1300
ELJPE15NKFA	15			9		2200	0.100	900
ELJPE18NKFA	18			9		2000	0.120	800
ELJPE22NKFA	22			9		1800	0.150	700

\*1 : Self Resonant Frequency \*2 : DC Resistance

Design and specifications are each subject to change without notice. Ask factory for the current technical specifications before purchase and/or use. Should a safety concern arise regarding this product, please be sure to contact us immediately.

00 Sep. 2010

■ PC Type 2520 (1008)/PC□3 Type 2520 (1008)

● Dimensions in mm (not to scale)

● Recommended Land Pattern in mm (not to scale)

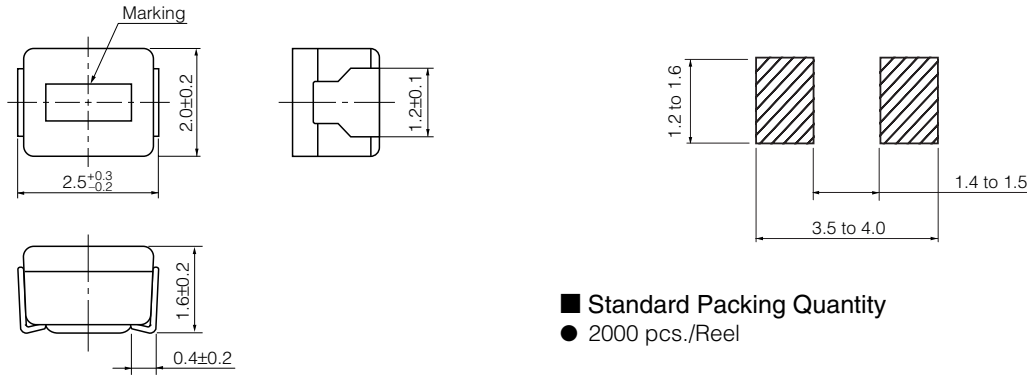

■ Standard Packing Quantity

● 2000 pcs./Reel

■ Standard Parts

Part No.	Inductance			Q		SRF *1 (MHz) min.	R <sub>DC</sub> *2 (Ω) max.	DC Current (mA) max.
	(μH)	Tolerance (%)	Test Freq. (MHz)	min.	Test Freq. (MHz)			
ELJPC1R0MF	1.0	M : ±20 %	7.96	10	7.96	95	0.45	475
ELJPC1R5MF	1.5					85	0.55	435
ELJPC2R2MF	2.2					65	0.65	390
ELJPC3R3MF	3.3			55		0.85	340	
ELJPC4R7MF	4.7			43		1.2	285	
ELJPC6R8KF	6.8	K : ±10 %	2.52	8.5	2.52	44	1.3	170
ELJPC100KF	10			32		2.2	210	
ELJPC120KF	12			25		2.7	195	
ELJPC150KF	15			21		3.2	175	
ELJPC220KF	22			18		4.0	160	
ELJPC330KF	33			16		6.5	120	

\*1 : Self Resonant Frequency \*2 : DC Resistance

**NEW** ■ Standard Parts(PC□3 Type)

Part No.	Inductance			Self Resonant Frequency (MHz) min.	DC Resistance (Ω)	Rated Current *1 (mA) max.	Saturation Rated Current *2 (mA) max.
	(μH)	Tolerance (%)	Test Freq. (MHz)				
ELJPC1R0MF3	1.0	±20 %	1	180	0.12 ±30 %	890	400
ELJPC2R2MF3	2.2			95	0.19 ±30 %	700	330
ELJPC3R3MF3	3.3			75	0.22 ±30 %	650	260
ELJPC4R7MF3	4.7			65	0.25 ±30 %	610	220
ELJPC100MF3	10			43	0.58 ±30 %	400	140
ELJPC220MF3	22			21	1.22 ±30 %	275	100

\*1 Rated current is defined by maximum temperature rise of 40 Celsius.

\*2 Saturation Rated Current is defined by 30% change of inductance. -dL/L<-30%

■ LC Type 2520 (1008)

● Dimensions in mm (not to scale)

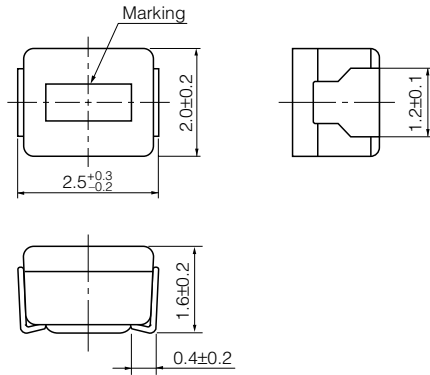

● Recommended Land Pattern in mm (not to scale)

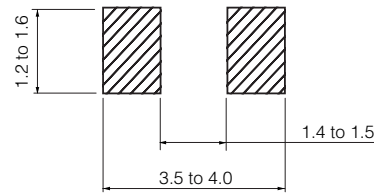

■ Standard Packing Quantity

● 2000 pcs./Reel

■ Standard Parts

Part No.	Inductance			DC Resistance (Ω)	Rated Current *1 (mA) max.	Saturation Rated Current *2 (mA) max.
	(μH)	Tolerance (%)	Test Freq. (MHz)			
ELJLC2R2MF	2.2	M : ±20 %	1	0.33 ±30 %	520	1050
ELJLC3R3MF	3.3			0.57 ±30 %	400	820
ELJLC4R7MF	4.7			0.75 ±30 %	350	700
ELJLC100KF	10	K : ±10 %		1.60 ±30 %	240	470

\*1 Rated current is defined by maximum temperature rise of 40 Celsius.

\*2 Saturation Rated Current is defined by 30% change of inductance. -dL/L < -30%

■ Performance Characteristics (Reference)

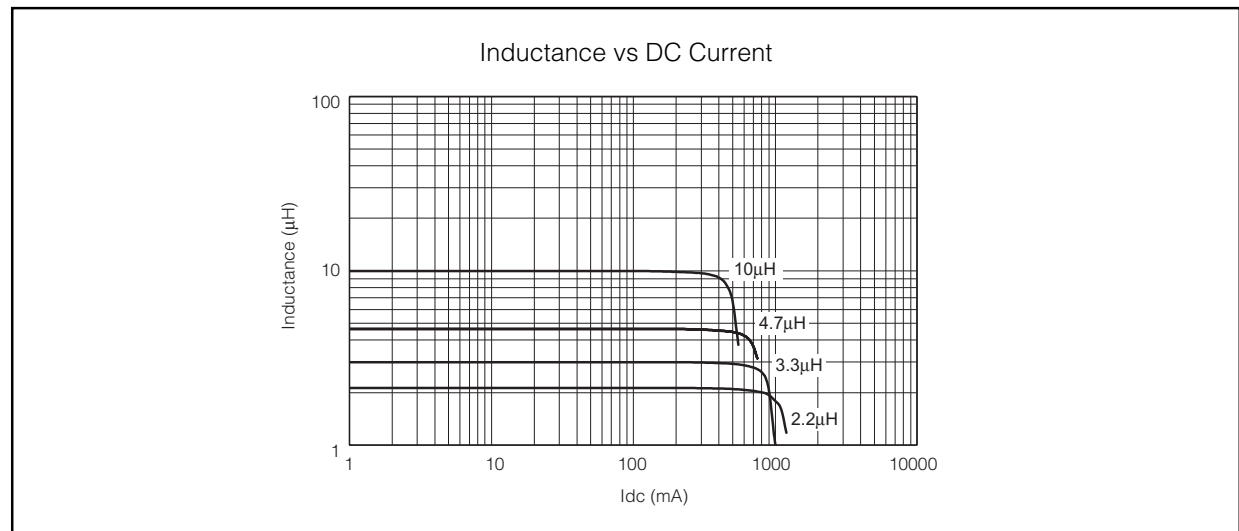

■ PA Type 3225 (1210)/PA□2 Type 3225 (1210)

● Dimensions in mm (not to scale)

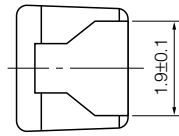
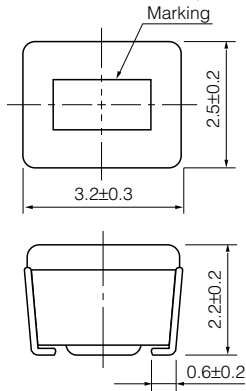

● Recommended Land Pattern in mm (not to scale)

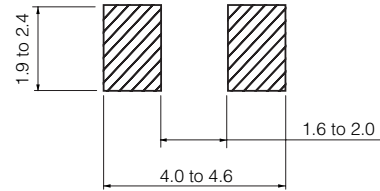

■ Standard Packing Quantity

- 2000 pcs./Reel

■ Standard Parts(PA Type)

Part No.	Inductance			Q		SRF *1 (MHz) min.	R <sub>DC</sub> *2 (Ω) max.	DC Current (mA) max.			
	(μH)	Tolerance (%)	Test Freq. (MHz)	min.	Test Freq. (MHz)						
ELJPA1R0MF	1.0	M : ±20 %	7.96	7	7.96	150	0.15	600			
ELJPA1R5MF	1.5					110	0.18	550			
ELJPA2R2MF	2.2					80	0.23	500			
ELJPA3R3MF	3.3					58	0.28	400			
ELJPA4R7MF	4.7					46	0.34	350			
ELJPA6R8MF	6.8					38	0.42	300			
ELJPA100KF	10	K : ±10 %	2.52	15	2.52	23	0.50	240			
ELJPA120KF	12					21	0.60	230			
ELJPA150KF	15					18	0.74	220			
ELJPA180KF	18					17	0.90	205			
ELJPA220KF	22					15	1.15	185			
ELJPA270KF	27					13	1.45	165			
ELJPA330KF	33					12	1.65	155			
ELJPA390KF	39					11	1.90	145			
ELJPA470KF	47					9.5	2.25	135			
ELJPA560KF	56					8.5	3.30	110			
ELJPA680KF	68					7.5	3.70	105			
ELJPA820KF	82					7.0	4.20	100			
ELJPA101KF	100					0.796	20	0.796	6.5	5.00	90
ELJPA121KF	120								6.0	7.00	75
ELJPA151KF	150								5.5	8.00	70
ELJPA181KF	180								5.0	9.50	65
ELJPA221KF	220								4.0	11.0	60
ELJPA271KF	270								3.5	14.5	55
ELJPA331KF	330	3.0	16.0	50							

\*1 : Self Resonant Frequency \*2 : DC Resistance

**NEW** ■ Standard Parts(PA□2 Type)

Part No.	Inductance			Self Resonant Frequency (MHz) min.	DC Resistance (Ω)	Rated Current *1 (mA) max.	Saturation Rated Current *2 (mA) max.
	(μH)	Tolerance (%)	Test Freq. (MHz)				
ELJPA1R0MF2	1.0	M : ±20 %	1	130	0.085 ±30 %	1150	1200
ELJPA2R2MF2	2.2			70	0.17 ±30 %	800	800
ELJPA3R3MF2	3.3			42	0.19 ±30 %	750	690
ELJPA4R7MF2	4.7			35	0.23 ±30 %	700	580
ELJPA6R8MF2	6.8			28	0.28 ±30 %	620	530
ELJPA100KF2	10			K : ±10 %	1	23	0.35 ±20 %
ELJPA220KF2	22	15	0.66 ±20 %			420	290
ELJPA330KF2	33	12	1.05 ±20 %			330	240
ELJPA470KF2	47	9.5	1.75 ±20 %			260	200
ELJPA680KF2	68	7.5	3.20 ±20 %			190	160
ELJPA101KF2	100	6.5	3.90 ±20 %			175	130
ELJPA221KF2	220	4.0	8.70 ±20 %			115	85

\*1 Rated current is defined by maximum temperature rise of 40 Celsius.

\*2 Saturation Rated Current is defined by 30% change of inductance. -dL/L<-30%

Design and specifications are each subject to change without notice. Ask factory for the current technical specifications before purchase and/or use. Should a safety concern arise regarding this product, please be sure to contact us immediately.

■ LA Type 3225 (1210)

● Dimensions in mm (not to scale)

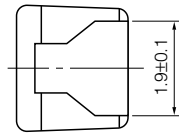
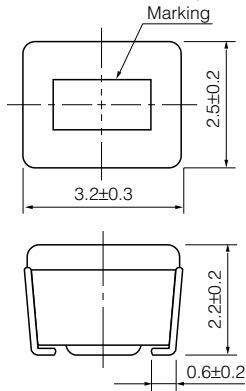

● Recommended Land Pattern in mm (not to scale)

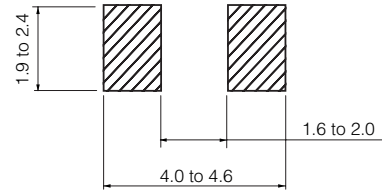

■ Standard Packing Quantity

- 2000 pcs./Reel

■ Standard Parts

Part No.	Inductance			DC Resistance (Ω)	Rated Current *1 (mA) max.	Saturation Rated Current *2 (mA) max.
	(μH)	Tolerance (%)	Test Freq. (MHz)			
ELJLA2R2KF	2.2	± 10 %	1	0.20 ±30 %	740	1400
ELJLA3R3KF	3.3			0.24 ±30 %	670	1200
ELJLA4R7KF	4.7			0.35 ±30 %	560	900
ELJLA6R8KF	6.8			0.55 ±30 %	460	800
ELJLA100KF	10			0.71 ±20 %	410	600
ELJLA220KF	22			1.90 ±20 %	250	420
ELJLA470KF	47			4.30 ±20 %	165	300
ELJLA680KF	68			5.50 ±20 %	145	260
ELJLA101KF	100			9.50 ±20 %	110	200

\*1 Rated current is defined by maximum temperature rise of 40 Celsius.

\*2 Saturation Rated Current is defined by 30% change of inductance. -dL/L<-30%

■ Performance Characteristics (Reference)

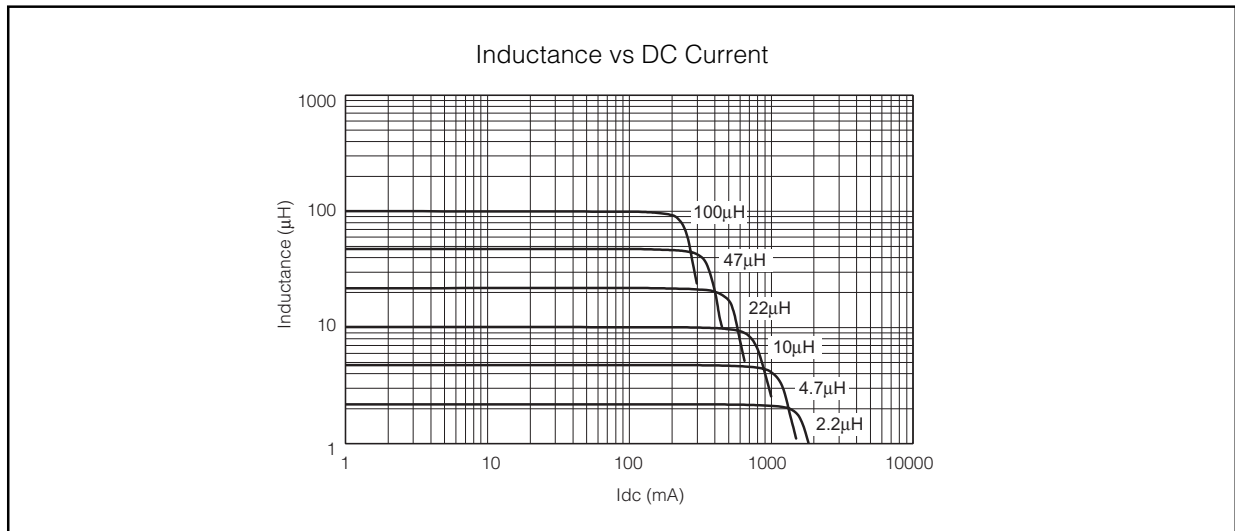

■ PB Type 4532 (1812)

● Dimensions in mm (not to scale)

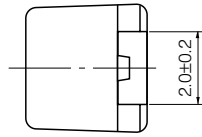
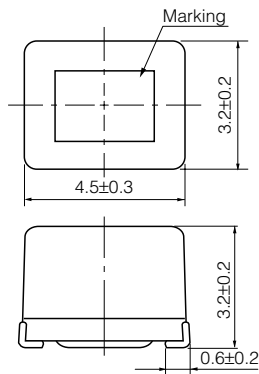

● Recommended Land Pattern in mm (not to scale)

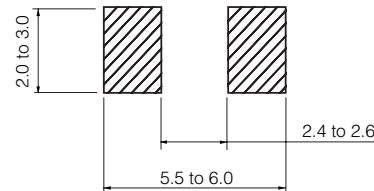

■ Standard Packing Quantity

● 500 pcs./Reel

■ Standard Parts

Part No.	Inductance			Q		SRF *1 (MHz) min.	R <sub>bc</sub> *2 (Ω) max.	DC Current (mA) max.			
	(μH)	Tolerance (%)	Test Freq. (MHz)	min.	Test Freq. (MHz)						
ELJPB100KF	10	K : ±10 %	2.52	10	2.52	19	0.65	360			
ELJPB120KF	12					17	0.70	340			
ELJPB150KF	15					15	0.80	320			
ELJPB180KF	18					14	0.90	310			
ELJPB220KF	22					13	1.0	300			
ELJPB270KF	27					11	1.2	270			
ELJPB330KF	33					10	1.4	250			
ELJPB390KF	39					9.5	1.6	230			
ELJPB470KF	47					8.5	1.9	210			
ELJPB560KF	56					8	2.2	190			
ELJPB680KF	68					7	2.6	170			
ELJPB820KF	82					6.5	3.5	160			
ELJPB101KF	100					6	4.0	150			
ELJPB121KF	120					0.796	20	0.796	5.5	4.5	130
ELJPB151KF	150								5	6.5	120
ELJPB181KF	180								4.5	7.5	110
ELJPB221KF	220	4	9.0	90							

\*1 : Self Resonant Frequency \*2 : DC Resistance