

### 3. General Use FC, FA, FB



#### ■ Features

- General use wire wound, resin molded chip inductor.
- Capable of being Re-flow or flow soldered.
- Wide line-up from 2520 to 4532 case sizes.
- Good for mounting.

#### ■ Recommended Applications

- AV equipment, Wireless communication equipment and various types of general electronic equipment.

#### ■ Explanation of Part Numbers

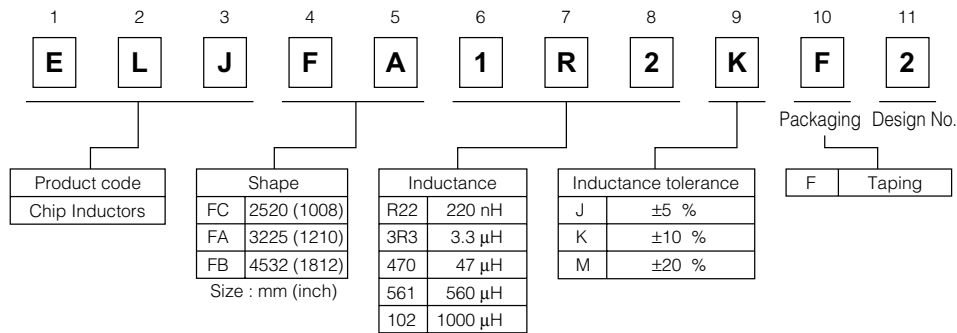

#### ■ Storage Conditions

- Package : Normal temperature (−5 to 35 °C), normal humidity (85 %RH max.), shall not be exposed to direct sunlight and harmful gases and care should be taken so as not to cause dew.
- Operating Temperature : −20 to +85 °C

#### ■ Storage Period

- Solderability may be reduced due to the conditions of high temperature and high humidity which causes the oxidation of tin-plated terminals. Even if storage conditions are within specified limits, solderability may be reduced with the passage of time. Therefore, please control the storage conditions and try to use the product within 6 months of receipt.

■ Packaging Methods                      Please see Page 127

■ Soldering Conditions                      Please see Page 128

■ Safety Precautions                      Please see Page 129

Design and specifications are each subject to change without notice. Ask factory for the current technical specifications before purchase and/or use. Should a safety concern arise regarding this product, please be sure to contact us immediately.

00 Sep. 2010

■ FC Type 2520 (1008)

● Dimensions in mm (not to scale)

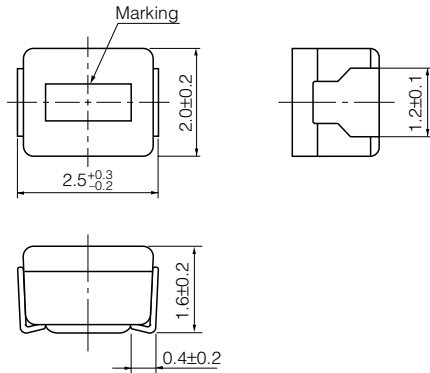

● Recommended Land Pattern in mm (not to scale)

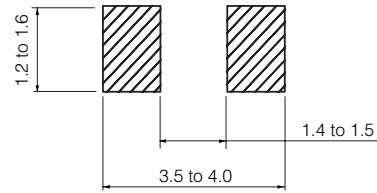

■ Standard Packing Quantity

● 2000 pcs./Reel

■ Standard Parts

| Part No.   | Inductance |                              |                     | Q     |                     | SRF *1<br>(MHz) min.        | R <sub>DC</sub> *2<br>(Ω) max. | DC Current<br>(mA) max. |      |     |      |     |
|------------|------------|------------------------------|---------------------|-------|---------------------|-----------------------------|--------------------------------|-------------------------|------|-----|------|-----|
|            | (μH)       | Tolerance<br>(%)             | Test Freq.<br>(MHz) | min.  | Test Freq.<br>(MHz) |                             |                                |                         |      |     |      |     |
| ELJFCR22□F | 0.22       | M : ±20 %<br>or<br>K : ±10 % | 25.2                |       | 25.2                | 230                         | 0.70                           | 190                     |      |     |      |     |
| ELJFCR27□F | 0.27       |                              |                     |       |                     | 210                         | 0.75                           | 180                     |      |     |      |     |
| ELJFCR33□F | 0.33       |                              |                     |       |                     | 190                         | 0.85                           | 170                     |      |     |      |     |
| ELJFCR39□F | 0.39       |                              |                     |       |                     | 175                         | 0.95                           | 160                     |      |     |      |     |
| ELJFCR47□F | 0.47       |                              |                     |       |                     | 160                         | 1.00                           | 155                     |      |     |      |     |
| ELJFCR56□F | 0.56       |                              |                     |       |                     | 155                         | 1.10                           | 150                     |      |     |      |     |
| ELJFCR68□F | 0.68       |                              |                     |       |                     | 135                         | 1.25                           | 140                     |      |     |      |     |
| ELJFCR82□F | 0.82       |                              |                     |       |                     | 125                         | 1.40                           | 130                     |      |     |      |     |
| ELJFC1R0□F | 1.0        |                              |                     |       |                     | K : ±10 %<br>or<br>J : ±5 % | 7.96                           | 25                      | 7.96 | 115 | 0.65 | 195 |
| ELJFC1R2□F | 1.2        |                              |                     |       |                     |                             |                                |                         |      | 100 | 0.75 | 180 |
| ELJFC1R5□F | 1.5        | 90                           | 0.85                | 170   |                     |                             |                                |                         |      |     |      |     |
| ELJFC1R8□F | 1.8        | 85                           | 0.95                | 160   |                     |                             |                                |                         |      |     |      |     |
| ELJFC2R2□F | 2.2        | 80                           | 1.05                | 155   |                     |                             |                                |                         |      |     |      |     |
| ELJFC2R7□F | 2.7        | 75                           | 1.20                | 145   |                     |                             |                                |                         |      |     |      |     |
| ELJFC3R3□F | 3.3        | 65                           | 1.30                | 135   |                     |                             |                                |                         |      |     |      |     |
| ELJFC3R9□F | 3.9        | 60                           | 1.40                | 130   |                     |                             |                                |                         |      |     |      |     |
| ELJFC4R7□F | 4.7        | 55                           | 1.55                | 125   |                     |                             |                                |                         |      |     |      |     |
| ELJFC5R6□F | 5.6        | 50                           | 1.75                | 120   |                     |                             |                                |                         |      |     |      |     |
| ELJFC6R8□F | 6.8        | 45                           | 1.95                | 115   |                     |                             |                                |                         |      |     |      |     |
| ELJFC8R2□F | 8.2        | 40                           | 2.20                | 105   |                     |                             |                                |                         |      |     |      |     |
| ELJFC100□F | 10         | 32                           | 3.70                | 80    |                     |                             |                                |                         |      |     |      |     |
| ELJFC120□F | 12         | 30                           | 4.10                | 75    |                     |                             |                                |                         |      |     |      |     |
| ELJFC150□F | 15         | 28                           | 5.00                | 70    |                     |                             |                                |                         |      |     |      |     |
| ELJFC180□F | 18         | 25                           | 5.40                | 65    |                     |                             |                                |                         |      |     |      |     |
| ELJFC220□F | 22         | 22                           | 6.00                | 60    |                     |                             |                                |                         |      |     |      |     |
| ELJFC270□F | 27         | 21                           | 6.30                | 115   |                     |                             |                                |                         |      |     |      |     |
| ELJFC330□F | 33         | 20                           | 7.10                | 110   |                     |                             |                                |                         |      |     |      |     |
| ELJFC390□F | 39         | 18                           | 9.50                | 90    |                     |                             |                                |                         |      |     |      |     |
| ELJFC470□F | 47         | 17                           | 11.0                | 80    |                     |                             |                                |                         |      |     |      |     |
| ELJFC560□F | 56         | 16                           | 12.1                | 75    |                     |                             |                                |                         |      |     |      |     |
| ELJFC680□F | 68         | 15                           | 16.6                | 70    |                     |                             |                                |                         |      |     |      |     |
| ELJFC820□F | 82         | 13                           | 19.0                | 65    |                     |                             |                                |                         |      |     |      |     |
| ELJFC101□F | 100        | 12                           | 21.0                | 60    |                     |                             |                                |                         |      |     |      |     |
|            |            | 0.796                        | 15                  | 0.796 |                     |                             |                                |                         |      |     |      |     |

□ : Symbol of Tolerance \*1 : Self Resonant Frequency \*2 : DC Resistance

■ FA Type 3225 (1210)

● Dimensions in mm (not to scale)

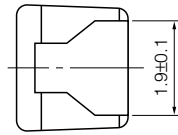
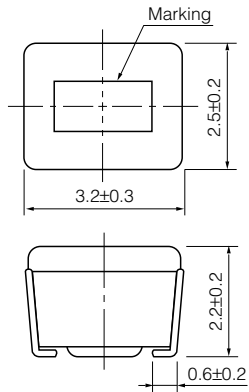

● Recommended Land Pattern in mm (not to scale)

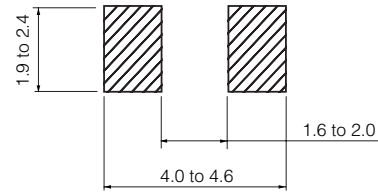

■ Standard Packing Quantity

● 2000 pcs./Reel

■ Standard Parts

| Part No.    | Inductance |                              |                     | Q    |                     | SRF *1<br>(MHz) min.        | R <sub>DC</sub> *2<br>(Ω) max. | DC Current<br>(mA) max. |
|-------------|------------|------------------------------|---------------------|------|---------------------|-----------------------------|--------------------------------|-------------------------|
|             | (μH)       | Tolerance<br>(%)             | Test Freq.<br>(MHz) | min. | Test Freq.<br>(MHz) |                             |                                |                         |
| ELJFAR22□F2 | 0.22       | M : ±20 %<br>or<br>K : ±10 % | 25.2                | 25   | 25.2                | 230                         | 0.29                           | 360                     |
| ELJFAR27□F2 | 0.27       |                              |                     |      |                     | 210                         | 0.32                           | 345                     |
| ELJFAR33□F2 | 0.33       |                              |                     |      |                     | 190                         | 0.35                           | 330                     |
| ELJFAR39□F2 | 0.39       |                              |                     |      |                     | 175                         | 0.39                           | 305                     |
| ELJFAR47□F2 | 0.47       |                              |                     |      |                     | 160                         | 0.44                           | 290                     |
| ELJFAR56□F2 | 0.56       |                              |                     |      |                     | 150                         | 0.49                           | 275                     |
| ELJFAR68□F2 | 0.68       |                              |                     |      |                     | 135                         | 0.55                           | 260                     |
| ELJFAR82□F2 | 0.82       |                              |                     |      |                     | 125                         | 0.61                           | 245                     |
| ELJFA1R0□F2 | 1.0        |                              |                     |      |                     | K : ±10 %<br>or<br>J : ±5 % | 7.96                           | 30                      |
| ELJFA1R2□F2 | 1.2        | 100                          | 0.75                | 215  |                     |                             |                                |                         |
| ELJFA1R5□F  | 1.5        | 90                           | 0.75                | 210  |                     |                             |                                |                         |
| ELJFA1R8□F  | 1.8        | 85                           | 0.82                | 200  |                     |                             |                                |                         |
| ELJFA2R2□F  | 2.2        | 80                           | 0.95                | 190  |                     |                             |                                |                         |
| ELJFA2R7□F  | 2.7        | 75                           | 1.1                 | 180  |                     |                             |                                |                         |
| ELJFA3R3□F  | 3.3        | 65                           | 1.2                 | 180  |                     |                             |                                |                         |
| ELJFA3R9□F  | 3.9        | 60                           | 1.3                 | 175  |                     |                             |                                |                         |
| ELJFA4R7□F  | 4.7        | 55                           | 1.5                 | 165  |                     |                             |                                |                         |
| ELJFA5R6□F  | 5.6        | 50                           | 1.6                 | 160  |                     |                             |                                |                         |
| ELJFA6R8□F  | 6.8        | 45                           | 1.8                 | 150  |                     |                             |                                |                         |
| ELJFA8R2□F  | 8.2        | 40                           | 2.0                 | 140  |                     |                             |                                |                         |
| ELJFA100□F  | 10         | 36                           | 2.1                 | 140  |                     |                             |                                |                         |
| ELJFA120□F  | 12         | 33                           | 2.5                 | 125  |                     |                             |                                |                         |
| ELJFA150□F  | 15         | 30                           | 2.8                 | 120  |                     |                             |                                |                         |
| ELJFA180□F  | 18         | 27                           | 3.3                 | 110  |                     |                             |                                |                         |
| ELJFA220□F  | 22         | 25                           | 3.7                 | 105  |                     |                             |                                |                         |
| ELJFA270□F  | 27         | 22                           | 5.0                 | 90   |                     |                             |                                |                         |
| ELJFA330□F  | 33         | 20                           | 5.6                 | 85   |                     |                             |                                |                         |
| ELJFA390□F  | 39         | 20                           | 6.4                 | 80   |                     |                             |                                |                         |
| ELJFA470□F  | 47         | 15                           | 7.0                 | 75   |                     |                             |                                |                         |
| ELJFA560□F  | 56         | 15                           | 8.0                 | 70   |                     |                             |                                |                         |
| ELJFA680□F  | 68         | 15                           | 9.0                 | 65   |                     |                             |                                |                         |
| ELJFA820□F  | 82         | 10                           | 10.0                | 60   |                     |                             |                                |                         |
| ELJFA101□F  | 100        | 10                           | 10.0                | 60   |                     |                             |                                |                         |
| ELJFA121□F  | 120        | 10                           | 11.0                | 55   |                     |                             |                                |                         |
| ELJFA151□F  | 150        | 8                            | 15.0                | 50   |                     |                             |                                |                         |
| ELJFA181□F  | 180        | 7                            | 17.0                | 50   |                     |                             |                                |                         |
| ELJFA221□F  | 220        | 7                            | 21.0                | 45   |                     |                             |                                |                         |

□ : Symbol of Tolerance \*1 : Self Resonant Frequency \*2 : DC Resistance

Design and specifications are each subject to change without notice. Ask factory for the current technical specifications before purchase and/or use. Should a safety concern arise regarding this product, please be sure to contact us immediately.

00 Sep. 2010

■ FB Type 4532 (1812)

● Dimensions in mm (not to scale)

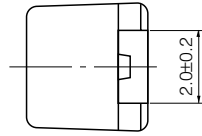
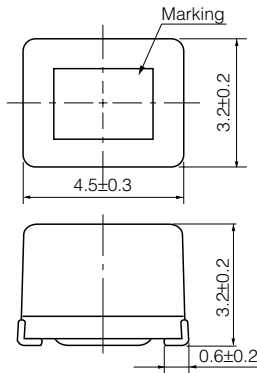

● Recommended Land Pattern in mm (not to scale)

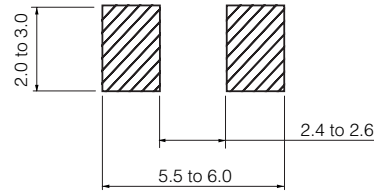

■ Standard Packing Quantity

● 500 pcs./Reel

■ Standard Parts

| Part No.   | Inductance |                             |                     | Q     |                     | SRF *1<br>(MHz) min. | R <sub>DC</sub> *2<br>(Ω) max. | DC Current<br>(mA) max. |
|------------|------------|-----------------------------|---------------------|-------|---------------------|----------------------|--------------------------------|-------------------------|
|            | (μH)       | Tolerance<br>(%)            | Test Freq.<br>(MHz) | min.  | Test Freq.<br>(MHz) |                      |                                |                         |
| ELJFBR22□F | 0.22       | M : ±20 %                   |                     | 30    | 25.2                | 230                  | 0.30                           | 700                     |
| ELJFBR27□F | 0.27       |                             |                     |       |                     | 200                  | 0.32                           | 650                     |
| ELJFBR33□F | 0.33       |                             |                     |       |                     | 180                  | 0.35                           | 630                     |
| ELJFBR39□F | 0.39       |                             |                     |       |                     | 155                  | 0.37                           | 620                     |
| ELJFBR47□F | 0.47       |                             |                     |       |                     | 135                  | 0.40                           | 580                     |
| ELJFBR56□F | 0.56       |                             |                     |       |                     | 120                  | 0.42                           | 560                     |
| ELJFBR68□F | 0.68       |                             |                     |       |                     | 105                  | 0.48                           | 530                     |
| ELJFBR82□F | 0.82       |                             |                     |       |                     | 90                   | 0.50                           | 500                     |
| ELJFB1R0□F | 1.0        | M:±20 %<br>or<br>K : ±10 %  | 1.0                 | 50    | 7.96                | 80                   | 0.52                           | 470                     |
| ELJFB1R2□F | 1.2        |                             |                     |       |                     | 70                   | 0.55                           | 460                     |
| ELJFB1R5□F | 1.5        |                             |                     |       |                     | 60                   | 0.61                           | 430                     |
| ELJFB1R8□F | 1.8        |                             |                     |       |                     | 50                   | 0.61                           | 410                     |
| ELJFB2R2□F | 2.2        |                             |                     |       |                     | 45                   | 0.61                           | 410                     |
| ELJFB2R7□F | 2.7        |                             |                     |       |                     | 43                   | 0.61                           | 400                     |
| ELJFB3R3□F | 3.3        |                             |                     |       |                     | 39                   | 0.66                           | 380                     |
| ELJFB3R9□F | 3.9        |                             |                     |       |                     | 36                   | 0.74                           | 360                     |
| ELJFB4R7□F | 4.7        |                             |                     |       |                     | 33                   | 0.81                           | 350                     |
| ELJFB5R6□F | 5.6        |                             |                     |       |                     | 30                   | 0.88                           | 330                     |
| ELJFB6R8□F | 6.8        | K : ±10 %<br>or<br>J : ±5 % | 0.1                 | 40    | 5                   | 26                   | 1.0                            | 310                     |
| ELJFB8R2□F | 8.2        |                             |                     |       |                     | 24                   | 1.6                            | 250                     |
| ELJFB100□F | 10         |                             |                     |       |                     | 22                   | 1.8                            | 235                     |
| ELJFB120□F | 12         |                             |                     |       |                     | 20                   | 1.9                            | 225                     |
| ELJFB150□F | 15         |                             |                     |       |                     | 18                   | 2.1                            | 215                     |
| ELJFB180□F | 18         |                             |                     |       |                     | 16                   | 2.3                            | 205                     |
| ELJFB220□F | 22         |                             |                     |       |                     | 15                   | 2.6                            | 195                     |
| ELJFB270□F | 27         |                             |                     |       |                     | 13                   | 2.9                            | 185                     |
| ELJFB330□F | 33         |                             |                     |       |                     | 12                   | 3.1                            | 175                     |
| ELJFB390□F | 39         |                             |                     |       |                     | 10                   | 3.6                            | 165                     |
| ELJFB470□F | 47         | 2.52                        | 30                  | 0.796 | 9.7                 | 4.2                  | 130                            |                         |
| ELJFB560□F | 56         |                             |                     |       | 9.0                 | 4.7                  | 125                            |                         |
| ELJFB680□F | 68         |                             |                     |       | 8.2                 | 5.3                  | 115                            |                         |
| ELJFB820□F | 82         |                             |                     |       | 7.5                 | 5.9                  | 110                            |                         |
| ELJFB101□F | 100        |                             |                     |       | 6.7                 | 8.8                  | 105                            |                         |
| ELJFB121□F | 120        |                             |                     |       | 6.1                 | 10                   | 100                            |                         |
| ELJFB151□F | 150        |                             |                     |       | 5.5                 | 11                   | 95                             |                         |
| ELJFB181□F | 180        |                             |                     |       | 5.1                 | 13                   | 85                             |                         |
| ELJFB221□F | 220        |                             |                     |       | 4.5                 | 13                   | 85                             |                         |
| ELJFB271□F | 270        |                             |                     |       | 4.1                 | 14                   | 80                             |                         |
| ELJFB331□F | 330        | 3.7                         | 16                  | 75    |                     |                      |                                |                         |
| ELJFB391□F | 390        | 3.3                         | 19                  | 70    |                     |                      |                                |                         |
| ELJFB471□F | 470        | 3.3                         | 31                  | 55    |                     |                      |                                |                         |
| ELJFB561□F | 560        | 2.7                         | 35                  | 50    |                     |                      |                                |                         |
| ELJFB681□F | 680        | 2.5                         | 39                  | 50    |                     |                      |                                |                         |
| ELJFB821□F | 820        | 2.4                         | 45                  | 45    |                     |                      |                                |                         |
| ELJFB102□F | 1000       | 2.1                         | 53                  | 40    |                     |                      |                                |                         |

□ : Symbol of Tolerance \*1 : Self Resonant Frequency \*2 : DC Resistance

Design and specifications are each subject to change without notice. Ask factory for the current technical specifications before purchase and/or use.  
Should a safety concern arise regarding this product, please be sure to contact us immediately.

00 Sep. 2010