

4. High Power Type PF, PE, PC, PA, PB, LC, LA



■ Features

- Low DCR and large current capability, suitable for power circuitry.
- Wire wound, resin molded chip inductor. (PC, PA, PB, LC, LA type)
- Unique Ceramic Core/Laser-cut technology (PF, PE type)
- Capable of being Re-flow or flow soldered.
- Wide line-up from 1005 to 4532 case sizes.
- Good for mounting.

■ Recommended Applications

- AV equipment, Wireless communication equipment and various types of general electronic equipment.

■ Explanation of Part Numbers

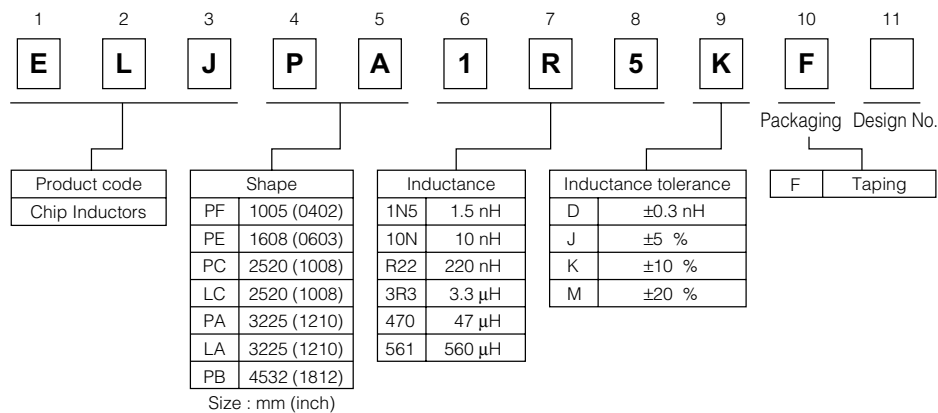

■ Storage Conditions

- Package : Normal temperature (−5 to 35 °C), normal humidity (85 %RH max.), shall not be exposed to direct sunlight and harmful gases and care should be taken so as not to cause dew.
- Operating Temperature : −20 to +85 °C

■ Storage Period

- Solderability may be reduced due to the conditions of high temperature and high humidity which causes the oxidation of tin-plated terminals. Even if storage conditions are within specified limits, solderability may be reduced with the passage of time. Therefore, please control the storage conditions and try to use the product within 6 months of receipt.

■ Packaging Methods Please see Page 127

■ Soldering Conditions Please see Page 128

■ Safety Precautions Please see Page 129

Design and specifications are each subject to change without notice. Ask factory for the current technical specifications before purchase and/or use. Should a safety concern arise regarding this product, please be sure to contact us immediately.

■ PF Type 1005 (0402)

● Dimensions in mm (not to scale)



● Recommended Land Pattern in mm (not to scale)



■ Standard Packing Quantity

● 10000 pcs./Reel

■ Standard Parts

| Part No. | Inductance | | | Q | | SRF *1 (MHz) min. | R _{DC} *2 (Ω) max. | DC Current (mA) max. |
|--------------|------------|---------------|---------------------|------|---------------------|----------------------|--------------------------------|-------------------------|
| | (nH) | Tolerance (%) | Test Freq. (MHz) | min. | Test Freq. (MHz) | | | |
| ELJPF2N2DFB | 2.2 | D : ±0.3 nH | 100 | 7 | 100 | 5300 | 0.040 | 1900 |
| ELJPF2N7DFB | 2.7 | | | | | 5300 | 0.050 | 1800 |
| ELJPF3N3DFB | 3.3 | | | | | 5000 | 0.070 | 1500 |
| ELJPF3N9DFB | 3.9 | | | | | 4800 | 0.080 | 1400 |
| ELJPF4N7DFB | 4.7 | | | | | 4600 | 0.100 | 1300 |
| ELJPF5N6DFB | 5.6 | | | | | 4200 | 0.120 | 1200 |
| ELJPF6N8JFB | 6.8 | J : ± 5 % | | | | 4000 | 0.160 | 1100 |
| ELJPF8N2JFB | 8.2 | | | | | 3700 | 0.210 | 900 |
| ELJPF10N1JFB | 10 | | | | | 3200 | 0.260 | 750 |

*1 : Self Resonant Frequency *2 : DC Resistance

■ PE Type 1608 (0603)

● Dimensions in mm (not to scale)

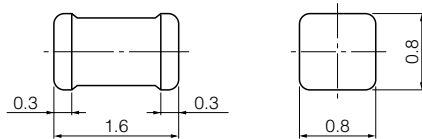

● Recommended Land Pattern in mm (not to scale)

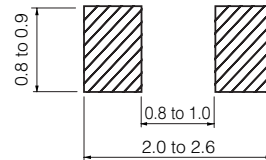

■ Standard Packing Quantity

● 3000 pcs./Reel

■ Standard Parts (E12 Series)

| Part No. | Inductance | | | Q | | SRF *1 (MHz) min. | R _{DC} *2 (Ω) max. | DC Current (mA) max. |
|-------------|------------|---------------|---------------------|------|---------------------|----------------------|--------------------------------|-------------------------|
| | (nH) | Tolerance (%) | Test Freq. (MHz) | min. | Test Freq. (MHz) | | | |
| ELJPE2N2KFA | 2.2 | K : ± 10 % | 100 | 8 | 100 | 6000 | 0.030 | 2100 |
| ELJPE2N7KFA | 2.7 | | | 8 | | 5500 | 0.030 | 2100 |
| ELJPE3N3KFA | 3.3 | | | 8 | | 5500 | 0.040 | 2100 |
| ELJPE3N9KFA | 3.9 | | | 9 | | 5200 | 0.040 | 2100 |
| ELJPE4N7KFA | 4.7 | | | 9 | | 4800 | 0.050 | 2100 |
| ELJPE5N6KFA | 5.6 | | | 9 | | 4600 | 0.055 | 2100 |
| ELJPE6N8KFA | 6.8 | | | 9 | | 4000 | 0.055 | 1900 |
| ELJPE8N2KFA | 8.2 | | | 9 | | 3500 | 0.060 | 1700 |
| ELJPE10NKFA | 10 | | | 9 | | 2800 | 0.065 | 1400 |
| ELJPE12NKFA | 12 | | | 9 | | 2500 | 0.080 | 1300 |
| ELJPE15NKFA | 15 | | | 9 | | 2200 | 0.100 | 900 |
| ELJPE18NKFA | 18 | | | 9 | | 2000 | 0.120 | 800 |
| ELJPE22NKFA | 22 | | | 9 | | 1800 | 0.150 | 700 |

*1 : Self Resonant Frequency *2 : DC Resistance

Design and specifications are each subject to change without notice. Ask factory for the current technical specifications before purchase and/or use. Should a safety concern arise regarding this product, please be sure to contact us immediately.

00 Sep. 2010

■ PC Type 2520 (1008)/PC□3 Type 2520 (1008)

● Dimensions in mm (not to scale)

● Recommended Land Pattern in mm (not to scale)

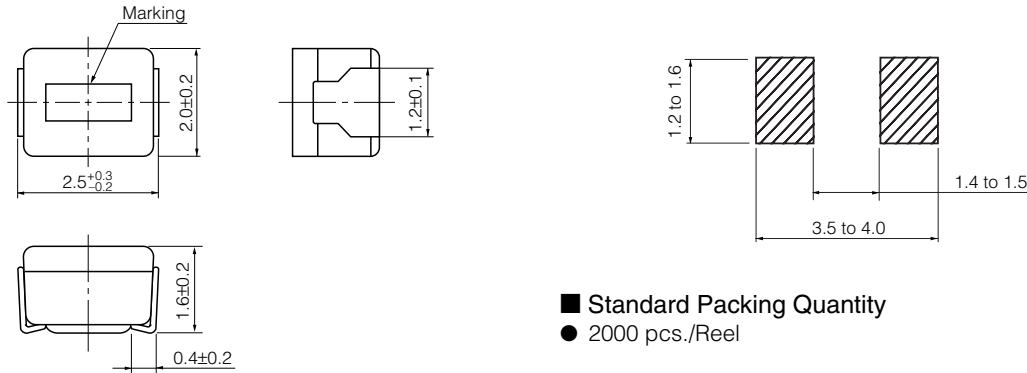

■ Standard Packing Quantity

● 2000 pcs./Reel

■ Standard Parts

| Part No. | Inductance | | | Q | | SRF *1 (MHz) min. | R _{DC} *2 (Ω) max. | DC Current (mA) max. |
|------------|------------|------------------|---------------------|------|---------------------|----------------------|--------------------------------|-------------------------|
| | (μH) | Tolerance (%) | Test Freq. (MHz) | min. | Test Freq. (MHz) | | | |
| ELJPC1R0MF | 1.0 | M : ±20 % | 7.96 | 10 | 7.96 | 95 | 0.45 | 475 |
| ELJPC1R5MF | 1.5 | | | | | 85 | 0.55 | 435 |
| ELJPC2R2MF | 2.2 | | | 65 | | 0.65 | 390 | |
| ELJPC3R3MF | 3.3 | | | 55 | | 0.85 | 340 | |
| ELJPC4R7MF | 4.7 | | | 43 | | 1.2 | 285 | |
| ELJPC6R8KF | 6.8 | K : ±10 % | 2.52 | 8.5 | 2.52 | 44 | 1.3 | 170 |
| ELJPC100KF | 10 | | | 32 | | 2.2 | 210 | |
| ELJPC120KF | 12 | | | 25 | | 2.7 | 195 | |
| ELJPC150KF | 15 | | | 21 | | 3.2 | 175 | |
| ELJPC220KF | 22 | | | 18 | | 4.0 | 160 | |
| ELJPC330KF | 33 | | | 16 | | 6.5 | 120 | |

*1 : Self Resonant Frequency *2 : DC Resistance

NEW ■ Standard Parts(PC□3 Type)

| Part No. | Inductance | | | Self Resonant Frequency (MHz) min. | DC Resistance (Ω) | Rated Current *1 (mA) max. | Saturation Rated Current *2 (mA) max. |
|-------------|------------|------------------|---------------------|--|----------------------|----------------------------------|---|
| | (μH) | Tolerance (%) | Test Freq. (MHz) | | | | |
| ELJPC1R0MF3 | 1.0 | ±20 % | 1 | 180 | 0.12 ±30 % | 890 | 400 |
| ELJPC2R2MF3 | 2.2 | | | 95 | 0.19 ±30 % | 700 | 330 |
| ELJPC3R3MF3 | 3.3 | | | 75 | 0.22 ±30 % | 650 | 260 |
| ELJPC4R7MF3 | 4.7 | | | 65 | 0.25 ±30 % | 610 | 220 |
| ELJPC100MF3 | 10 | | | 43 | 0.58 ±30 % | 400 | 140 |
| ELJPC220MF3 | 22 | | | 21 | 1.22 ±30 % | 275 | 100 |

*1 Rated current is defined by maximum temperature rise of 40 Celsius.

*2 Saturation Rated Current is defined by 30% change of inductance. -dL/L<-30%

■ LC Type 2520 (1008)

● Dimensions in mm (not to scale)

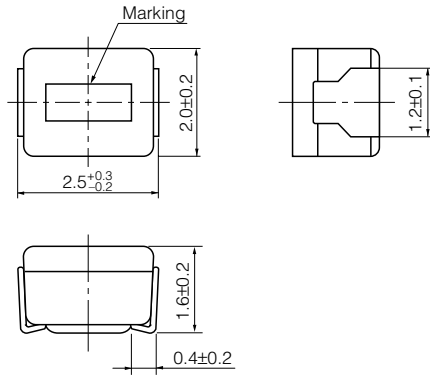

● Recommended Land Pattern in mm (not to scale)

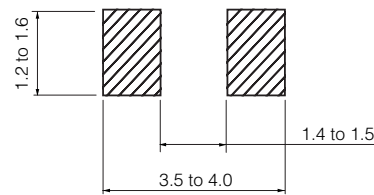

■ Standard Packing Quantity

● 2000 pcs./Reel

■ Standard Parts

| Part No. | Inductance | | | DC Resistance (Ω) | Rated Current *1 (mA) max. | Saturation Rated Current *2 (mA) max. |
|------------|------------|---------------|------------------|-------------------|----------------------------|---------------------------------------|
| | (μH) | Tolerance (%) | Test Freq. (MHz) | | | |
| ELJLC2R2MF | 2.2 | M : ±20 % | 1 | 0.33 ±30 % | 520 | 1050 |
| ELJLC3R3MF | 3.3 | | | 0.57 ±30 % | 400 | 820 |
| ELJLC4R7MF | 4.7 | | | 0.75 ±30 % | 350 | 700 |
| ELJLC100KF | 10 | K : ±10 % | | 1.60 ±30 % | 240 | 470 |

*1 Rated current is defined by maximum temperature rise of 40 Celsius.

*2 Saturation Rated Current is defined by 30% change of inductance. -dL/L < -30%

■ Performance Characteristics (Reference)

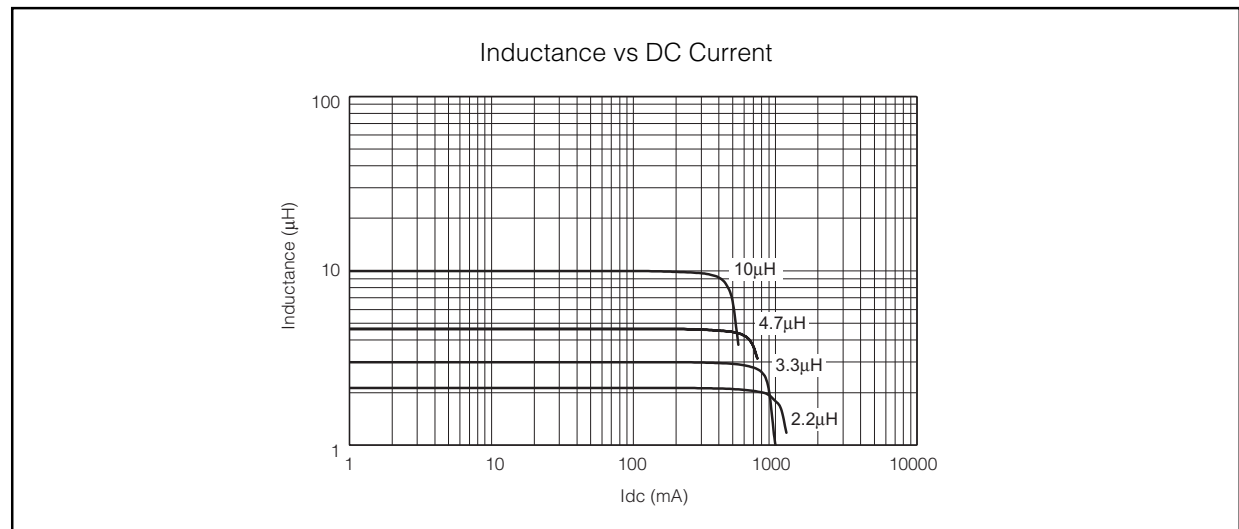

■ PA Type 3225 (1210)/PA□2 Type 3225 (1210)

● Dimensions in mm (not to scale)

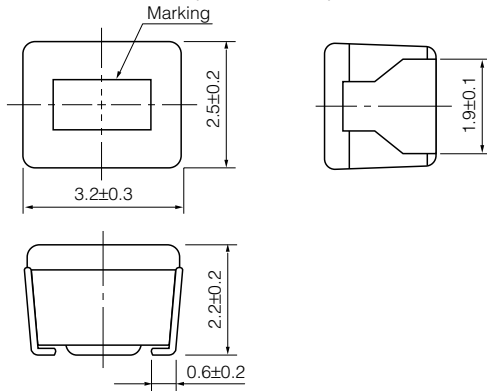

● Recommended Land Pattern in mm (not to scale)

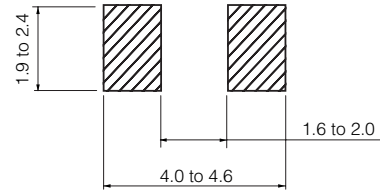

■ Standard Packing Quantity

- 2000 pcs./Reel

■ Standard Parts(PA Type)

| Part No. | Inductance | | | Q | | SRF *1 (MHz) min. | R _{DC} *2 (Ω) max. | DC Current (mA) max. | | | |
|------------|------------|---------------|------------------|------|------------------|----------------------|--------------------------------|-------------------------|-----|------|----|
| | (μH) | Tolerance (%) | Test Freq. (MHz) | min. | Test Freq. (MHz) | | | | | | |
| ELJPA1R0MF | 1.0 | M : ±20 % | 7.96 | 7 | 7.96 | 150 | 0.15 | 600 | | | |
| ELJPA1R5MF | 1.5 | | | | | 110 | 0.18 | 550 | | | |
| ELJPA2R2MF | 2.2 | | | | | 80 | 0.23 | 500 | | | |
| ELJPA3R3MF | 3.3 | | | | | 58 | 0.28 | 400 | | | |
| ELJPA4R7MF | 4.7 | | | | | 46 | 0.34 | 350 | | | |
| ELJPA6R8MF | 6.8 | | | | | 38 | 0.42 | 300 | | | |
| ELJPA100KF | 10 | K : ±10 % | 2.52 | 15 | 2.52 | 23 | 0.50 | 240 | | | |
| ELJPA120KF | 12 | | | | | 21 | 0.60 | 230 | | | |
| ELJPA150KF | 15 | | | | | 18 | 0.74 | 220 | | | |
| ELJPA180KF | 18 | | | | | 17 | 0.90 | 205 | | | |
| ELJPA220KF | 22 | | | | | 15 | 1.15 | 185 | | | |
| ELJPA270KF | 27 | | | | | 13 | 1.45 | 165 | | | |
| ELJPA330KF | 33 | | | | | 12 | 1.65 | 155 | | | |
| ELJPA390KF | 39 | | | | | 11 | 1.90 | 145 | | | |
| ELJPA470KF | 47 | | | | | 9.5 | 2.25 | 135 | | | |
| ELJPA560KF | 56 | | | | | 8.5 | 3.30 | 110 | | | |
| ELJPA680KF | 68 | | | | | 7.5 | 3.70 | 105 | | | |
| ELJPA820KF | 82 | | | | | 7.0 | 4.20 | 100 | | | |
| ELJPA101KF | 100 | | | | | 0.796 | 20 | 0.796 | 6.5 | 5.00 | 90 |
| ELJPA121KF | 120 | | | | | | | | 6.0 | 7.00 | 75 |
| ELJPA151KF | 150 | | | | | | | | 5.5 | 8.00 | 70 |
| ELJPA181KF | 180 | | | | | | | | 5.0 | 9.50 | 65 |
| ELJPA221KF | 220 | | | | | | | | 4.0 | 11.0 | 60 |
| ELJPA271KF | 270 | | | | | | | | 3.5 | 14.5 | 55 |
| ELJPA331KF | 330 | 3.0 | 16.0 | 50 | | | | | | | |

*1 : Self Resonant Frequency *2 : DC Resistance

NEW ■ Standard Parts(PA□2 Type)

| Part No. | Inductance | | | Self Resonant Frequency (MHz) min. | DC Resistance (Ω) | Rated Current *1 (mA) max. | Saturation Rated Current *2 (mA) max. |
|-------------|------------|---------------|------------------|------------------------------------|-------------------|----------------------------|---------------------------------------|
| | (μH) | Tolerance (%) | Test Freq. (MHz) | | | | |
| ELJPA1R0MF2 | 1.0 | M : ±20 % | 1 | 130 | 0.085 ±30 % | 1150 | 1200 |
| ELJPA2R2MF2 | 2.2 | | | 70 | 0.17 ±30 % | 800 | 800 |
| ELJPA3R3MF2 | 3.3 | | | 42 | 0.19 ±30 % | 750 | 690 |
| ELJPA4R7MF2 | 4.7 | | | 35 | 0.23 ±30 % | 700 | 580 |
| ELJPA6R8MF2 | 6.8 | | | 28 | 0.28 ±30 % | 620 | 530 |
| ELJPA100KF2 | 10 | | | K : ±10 % | 1 | 23 | 0.35 ±20 % |
| ELJPA220KF2 | 22 | 15 | 0.66 ±20 % | | | 420 | 290 |
| ELJPA330KF2 | 33 | 12 | 1.05 ±20 % | | | 330 | 240 |
| ELJPA470KF2 | 47 | 9.5 | 1.75 ±20 % | | | 260 | 200 |
| ELJPA680KF2 | 68 | 7.5 | 3.20 ±20 % | | | 190 | 160 |
| ELJPA101KF2 | 100 | 6.5 | 3.90 ±20 % | | | 175 | 130 |
| ELJPA221KF2 | 220 | 4.0 | 8.70 ±20 % | | | 115 | 85 |

*1 Rated current is defined by maximum temperature rise of 40 Celsius.

*2 Saturation Rated Current is defined by 30% change of inductance. -dL/L<-30%

Design and specifications are each subject to change without notice. Ask factory for the current technical specifications before purchase and/or use. Should a safety concern arise regarding this product, please be sure to contact us immediately.

■ LA Type 3225 (1210)

● Dimensions in mm (not to scale)



● Recommended Land Pattern in mm (not to scale)

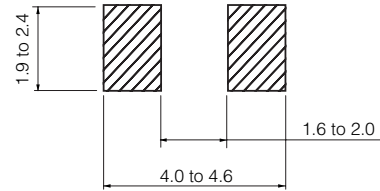

■ Standard Packing Quantity

- 2000 pcs./Reel

■ Standard Parts

| Part No. | Inductance | | | DC Resistance (Ω) | Rated Current *1 (mA) max. | Saturation Rated Current *2 (mA) max. |
|------------|------------|---------------|------------------|-------------------|----------------------------|---------------------------------------|
| | (μH) | Tolerance (%) | Test Freq. (MHz) | | | |
| ELJLA2R2KF | 2.2 | ± 10 % | 1 | 0.20 ±30 % | 740 | 1400 |
| ELJLA3R3KF | 3.3 | | | 0.24 ±30 % | 670 | 1200 |
| ELJLA4R7KF | 4.7 | | | 0.35 ±30 % | 560 | 900 |
| ELJLA6R8KF | 6.8 | | | 0.55 ±30 % | 460 | 800 |
| ELJLA100KF | 10 | | | 0.71 ±20 % | 410 | 600 |
| ELJLA220KF | 22 | | | 1.90 ±20 % | 250 | 420 |
| ELJLA470KF | 47 | | | 4.30 ±20 % | 165 | 300 |
| ELJLA680KF | 68 | | | 5.50 ±20 % | 145 | 260 |
| ELJLA101KF | 100 | | | 9.50 ±20 % | 110 | 200 |

*1 Rated current is defined by maximum temperature rise of 40 Celsius.

*2 Saturation Rated Current is defined by 30% change of inductance. -dL/L<-30%

■ Performance Characteristics (Reference)

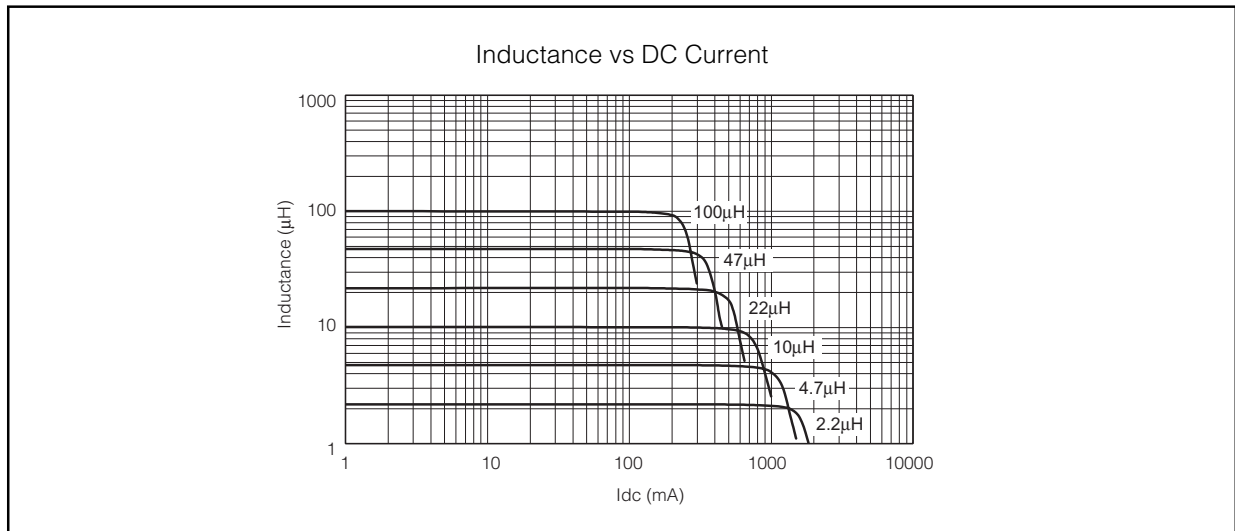

■ PB Type 4532 (1812)

● Dimensions in mm (not to scale)

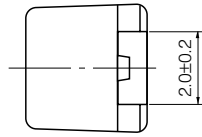
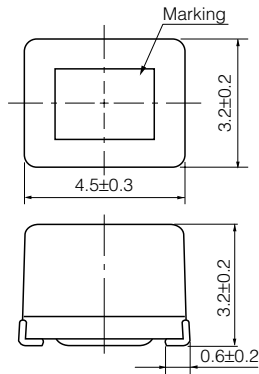

● Recommended Land Pattern in mm (not to scale)

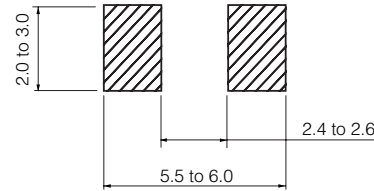

■ Standard Packing Quantity

● 500 pcs./Reel

■ Standard Parts

| Part No. | Inductance | | | Q | | SRF *1 (MHz) min. | R _{bc} *2 (Ω) max. | DC Current (mA) max. | | | |
|------------|------------|------------------|---------------------|------|---------------------|----------------------|--------------------------------|-------------------------|-----|-----|-----|
| | (μH) | Tolerance (%) | Test Freq. (MHz) | min. | Test Freq. (MHz) | | | | | | |
| ELJPB100KF | 10 | K : ±10 % | 2.52 | 10 | 2.52 | 19 | 0.65 | 360 | | | |
| ELJPB120KF | 12 | | | | | 17 | 0.70 | 340 | | | |
| ELJPB150KF | 15 | | | | | 15 | 0.80 | 320 | | | |
| ELJPB180KF | 18 | | | | | 14 | 0.90 | 310 | | | |
| ELJPB220KF | 22 | | | | | 13 | 1.0 | 300 | | | |
| ELJPB270KF | 27 | | | | | 11 | 1.2 | 270 | | | |
| ELJPB330KF | 33 | | | | | 10 | 1.4 | 250 | | | |
| ELJPB390KF | 39 | | | | | 9.5 | 1.6 | 230 | | | |
| ELJPB470KF | 47 | | | | | 8.5 | 1.9 | 210 | | | |
| ELJPB560KF | 56 | | | | | 8 | 2.2 | 190 | | | |
| ELJPB680KF | 68 | | | | | 7 | 2.6 | 170 | | | |
| ELJPB820KF | 82 | | | | | 6.5 | 3.5 | 160 | | | |
| ELJPB101KF | 100 | | | | | 0.796 | 20 | 0.796 | 6 | 4.0 | 150 |
| ELJPB121KF | 120 | | | | | | | | 5.5 | 4.5 | 130 |
| ELJPB151KF | 150 | | | | | | | | 5 | 6.5 | 120 |
| ELJPB181KF | 180 | | | | | | | | 4.5 | 7.5 | 110 |
| ELJPB221KF | 220 | 4 | 9.0 | 90 | | | | | | | |

*1 : Self Resonant Frequency *2 : DC Resistance