

FEATURES

KEMET's Open Mode Ceramic Surface Mount Capacitor is designed to significantly minimize the probability of a low IR or Short Circuit Condition when forced to failure in a board flex situation. This reduces the potential for causing catastrophic failures. This product is RoHS Compliant.

Applications:

- Input side filtering (power plane/bus)
- High current applications (battery line)
- Circuits that cannot be fused to open when short circuits occur due to flex cracks

Markets:

- *Automotive*
 - All applications connected directly to the battery
 - Conversion to 42V power system
- *Power Conversion*
 - Raw power input side filtering

OUTLINE DRAWING

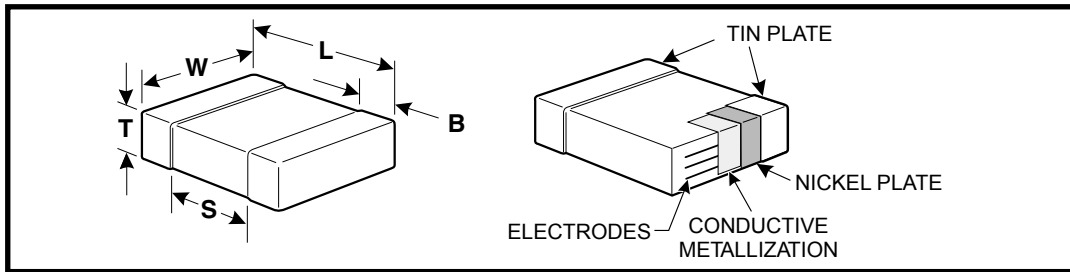
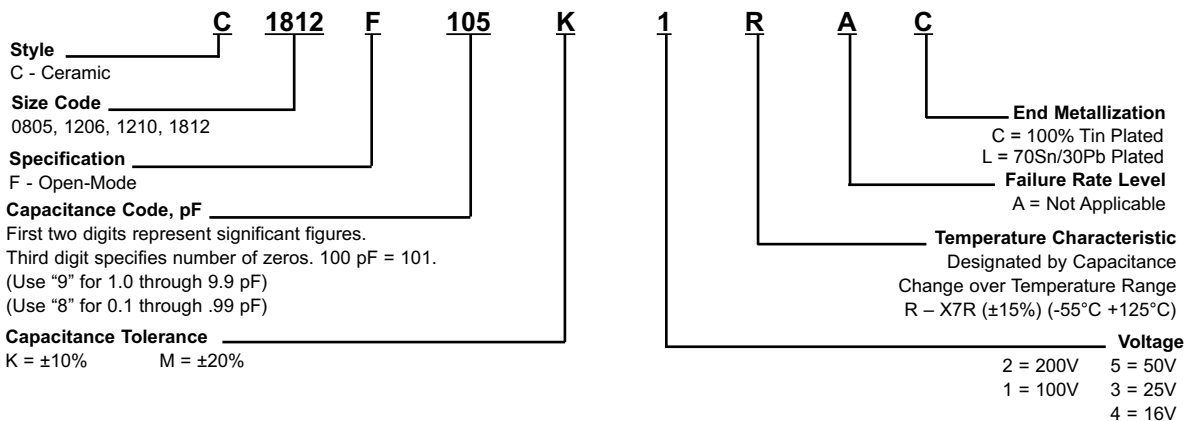

TABLE 1 - DIMENSIONS - MILLIMETERS (INCHES)

| Metric Size Code | EIA Size Code | L - Length | W - Width | B - Bandwidth | Separation |
|------------------|---------------|-------------------------|--------------------------|--------------------------|-------------|
| 2012 | 0805 | 2.0 (.079) ± .20 (.008) | 1.25 (.049) ± 0.2 (.008) | 0.50 (.02) ± .25 (.010) | 0.75 (.030) |
| 3216 | 1206 | 3.2 (.126) ± .20 (.008) | 1.6 (.063) ± 0.2 (.008) | 0.50 (.02) ± .25 (.010) | N/A |
| 3225 | 1210 | 3.2 (.126) ± .20 (.008) | 2.5 (.098) ± 0.2 (.008) | 0.50 (.02) ± .25 (.010) | N/A |
| 4532 | 1812 | 4.5 (.177) ± 0.3 (.012) | 3.2 (.126) ± 0.3 (.012) | 0.60 (.024) ± .35 (.014) | N/A |

Note: For thickness dimensions, see Table 2.

CAPACITOR ORDERING INFORMATION



OPEN-MODE INTERNAL DESIGN

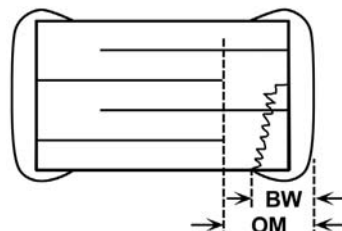

The open-mode dimension (OM) exceeds the termination bandwidth dimensions: OM > BW

TABLE 2
X7R DIELECTRIC CAPACITANCE RANGE AND THICKNESS TARGETS (mm)

| Cap Code | 0805 | | | | | 1206 | | | | | 1210 | | | | | 1812 | | | |
|----------|------|-----|-----|------|------|------|-----|-----|------|------|------|-----|-----|------|------|------|-----|------|------|
| | 16V | 25V | 50V | 100V | 200V | 16V | 25V | 50V | 100V | 200V | 16V | 25V | 50V | 100V | 200V | 25V | 50V | 100V | 200V |
| 102 | DD | DD | DD | DD | DD | | | | | | | | | | | | | | |
| 122 | DD | DD | DD | DD | DD | | | | | | | | | | | | | | |
| 152 | DD | DD | DD | DD | DD | | | | | | | | | | | | | | |
| 182 | DD | DD | DD | DD | DD | | | | | | | | | | | | | | |
| 222 | DD | DD | DD | DD | DD | | | | | | | | | | | | | | |
| 272 | DD | DD | DD | DD | DD | | | | | | | | | | | | | | |
| 332 | DD | DD | DD | DD | DD | | | | | | | | | | | | | | |
| 392 | DD | DD | DD | DD | DD | | | | | | | | | | | | | | |
| 472 | DD | DD | DD | DD | DD | | | | | | | | | | | | | | |
| 562 | DD | DD | DD | DD | DD | | | | | | | | | | | | | | |
| 682 | DD | DD | DD | DD | DD | | | | | | | | | | | | | | |
| 822 | DD | DD | DD | DD | DD | | | | | | | | | | | | | | |
| 103 | DD | DD | DD | DD | DD | | | | | | | | | | | | | | |
| 123 | DD | DD | DD | DD | DG | | | | | | | | | | | | | | |
| 153 | DD | DD | DD | DD | DG | | | | | | | | | | | | | | |
| 183 | DD | DD | DD | DD | DD | | | | | | | | | | | | | | |
| 223 | DD | DD | DD | DD | DG | | | | | | | | | | | | | | |
| 273 | DD | DD | DD | DD | DG | | | | | | | | | | | | | | |
| 333 | DD | DD | DD | DD | DG | | | | | | | | | | | | | | |
| 393 | DD | DD | DD | DD | DG | | | | | | | | | | | | | | |
| 473 | DD | DD | DD | DE | | EC | EC | EC | EC | EG | | | | | | | | | GB |
| 563 | DD | DD | DD | DD | | EC | EC | EC | EC | EG | | | | | | | | | GB |
| 683 | DD | DD | DG | DG | | EC | EC | EC | EC | EG | | | | | FD | | | | GB |
| 823 | DD | DD | DG | DG | | EC | EC | EC | EC | EG | | | | | FD | | | | GB |
| 104 | DG | DG | DG | | | EC | EC | EC | EC | EG | FD | FD | FD | FD | FG | GB | GB | GB | GB |
| 124 | DG | DG | | | | EC | EC | EC | EC | | FD | FD | FD | FD | FG | GB | GB | GB | GB |
| 154 | DG | DG | | | | EC | EC | EC | EG | | FD | FD | FD | FD | FH | GB | GB | GB | GB |
| 184 | DG | DG | | | | EC | EC | EC | EG | | FD | FD | FD | FD | FH | GB | GB | GB | GB |
| 224 | DG | DD | DG | | | EC | EC | EC | ED | | FD | FD | FD | FG | FJ | GB | GB | GB | GC |
| 274 | DD | DD | | | | EC | EC | EC | | | FD | FD | FD | FG | | GB | GB | GB | GF |
| 334 | DG | DG | | | | EG | EG | EG | EG | | FD | FD | FD | FH | | GB | GB | GB | GK |
| 394 | DG | DG | | | | EG | EG | | | | FD | FD | FG | FH | | GB | GB | GB | GL |
| 474 | DE | DG | | | | EG | EG | EC | | | FD | FD | FG | FJ | | GB | GB | GC | |
| 564 | | | | | | EG | | | | | FD | FD | FG | FR | | GB | GB | GD | |
| 684 | DG | | | | | EG | | | | | FD | FG | FH | FR | | GD | GD | GF | |
| 824 | | | | | | EG | | | | | FD | FG | FJ | | | GD | GD | GK | |
| 105 | | | | | | EG | EC | EH | | | FD | FH | FJ | FQ | | GN | GN | GM | |
| 125 | | | | | | | | | | | FG | | | | | | | | |
| 155 | | | | | | | | | | | FH | | | | | | | | |
| 185 | | | | | | | | | | | FH | | | | | | | | |
| 225 | | | | | | EC | EH | | | | FJ | | FM | | | | | | |
| 475 | | | | | | EH | | | | | FG | FM | | | | | | | |
| 685 | | | | | | | | | | | | FQ | | | | | | | |

THICKNESS AND PACKAGING INFORMATION

| Thickness Code | Series | Dimension | 7" Reel Qty. | 13" Reel Qty. |
|----------------|--------|------------|--------------|---------------|
| DD | 0805 | .90 ± .10 | 4000 | 10000 |
| DE | 0805 | 1.00 ± .10 | 2500 | 10000 |
| DG | 0805 | 1.25 ± .15 | 2500 | 10000 |
| EC | 1206 | .90 ± .10 | 4000 | 10000 |
| ED | 1206 | 1.00 ± .10 | 2500 | 10000 |
| EG | 1206 | 1.60 ± .15 | 2000 | 8000 |
| EH | 1206 | 1.60 ± .20 | 2000 | 8000 |
| FD | 1210 | .95 ± .10 | 4000 | 10000 |
| FG | 1210 | 1.25 ± .15 | 2500 | 10000 |
| FH | 1210 | 1.55 ± .15 | 2000 | 8000 |
| FJ | 1210 | 1.85 ± .20 | 2000 | 8000 |
| FM | 1210 | 1.70 ± .20 | 2000 | 8000 |
| FR | 1210 | 2.25 ± .20 | 2000 | 8000 |
| FQ | 1210 | 2.5 ± .20 | 1500 | 8000 |
| GB | 1812 | 1.0 ± .10 | 1000 | 4000 |
| GC | 1812 | 1.1 ± .10 | 1000 | 4000 |
| GD | 1812 | 1.25 ± .15 | 1000 | 4000 |
| GF | 1812 | 1.50 ± .15 | 1000 | 4000 |
| GK | 1812 | 1.60 ± .20 | 1000 | 4000 |
| GL | 1812 | 1.90 ± .20 | 1000 | 4000 |
| GM | 1812 | 2.00 ± .20 | 1000 | 4000 |
| GN | 1812 | 1.70 ± .20 | 1000 | 4000 |

Tape & Reel Packaging

KEMET offers Multilayer Ceramic Chip Capacitors packaged in 8mm and 12mm plastic tape on 7" and 13" reels in accordance with EIA standard 481-1: Taping of surface mount components for automatic handling. This packaging system is compatible with all tape fed automatic pick and place systems. See page 78 for details on reeling quantities for commercial chips and page 87 for MIL-PRF-55681 chips.

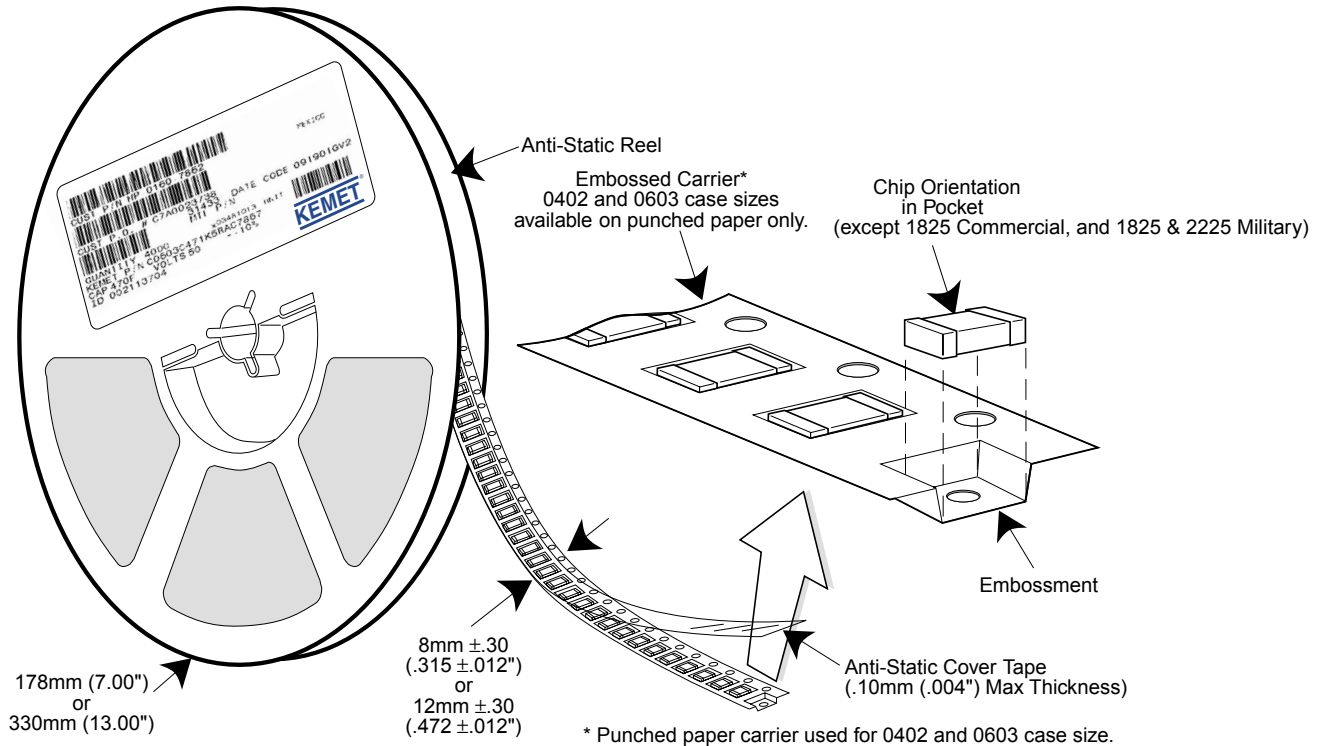

Case Sizes ≤ 1210 are 8 mm tape with 4 mm pitch.

Case Sizes > 1210 are 12 mm tape with 8 mm pitch

Note: TU suffix represents tape and reel packaging of marked components.

TM suffix represents tape and reel packaging of marked components.

SURFACE MOUNT LAND DIMENSIONS - CERAMIC CHIP CAPACITORS - MM

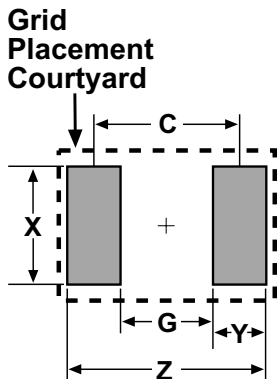

| Dimension | Reflow Solder | | | | | Wave Solder | | | | |
|-----------|---------------|------|------|--------|--------|-----------------|------|------|--------|------|
| | Z | G | X | Y(ref) | C(ref) | Z | G | X | Y(ref) | Smin |
| 0402 | 2.14 | 0.28 | 0.74 | 0.93 | 1.21 | Not Recommended | | | | |
| 0603 | 2.78 | 0.68 | 1.08 | 1.05 | 1.73 | 3.18 | 0.68 | 0.80 | 1.25 | 1.93 |
| 0805 | 3.30 | 0.70 | 1.60 | 1.30 | 2.00 | 3.70 | 0.70 | 1.10 | 1.50 | 2.20 |
| 1206 | 4.50 | 1.50 | 2.00 | 1.50 | 3.00 | 4.90 | 1.50 | 1.40 | 1.70 | 3.20 |
| 1210 | 4.50 | 1.50 | 2.90 | 1.50 | 3.00 | 4.90 | 1.50 | 2.00 | 1.70 | 3.20 |
| 1812 | 5.90 | 2.30 | 3.70 | 1.80 | 4.10 | Not Recommended | | | | |
| 1825 | 5.90 | 2.30 | 6.90 | 1.80 | 4.10 | | | | | |
| 2220 | 7.00 | 3.30 | 5.50 | 1.85 | 5.15 | | | | | |
| 2225 | 7.00 | 3.30 | 6.80 | 1.85 | 5.15 | | | | | |

Calculation Formula

$$Z = Lmin + 2Jt + Tt$$

$$G = Smax - 2Jh - Th$$

$$X = Wmin + 2Js + Ts$$

Tt, Th, Ts = Combined tolerances

TANTALUM, CERAMIC AND ALUMINUM CHIP CAPACITORS

Packaging Information

Performance Notes

- Cover Tape Break Force:** 1.0 Kg Minimum.
- Cover Tape Peel Strength:** The total peel strength of the cover tape from the carrier tape shall be:

| Tape Width | Peel Strength |
|------------|--|
| 8 mm | 0.1 Newton to 1.0 Newton (10g to 100g) |
| 12 mm | 0.1 Newton to 1.3 Newton (10g to 130g) |

The direction of the pull shall be opposite the direction of the carrier tape travel. The pull angle of the carrier tape shall be 165° to 180° from the plane of the carrier tape. During peeling, the carrier and/or cover tape shall be pulled at a velocity of 300 ±10 mm/minute.

- Reel Sizes:** Molded tantalum capacitors are available on either 180 mm (7") reels (standard) or 330 mm (13") reels (with C-7280). Note that 13" reels are preferred.
- Labeling:** Bar code labeling (standard or custom) shall be on the side of the reel opposite the sprocket holes. Refer to EIA-556.

Embossed Carrier Tape Configuration: Figure 1



Table 1 — EMBOSSED TAPE DIMENSIONS (Metric will govern)

| Constant Dimensions — Millimeters (Inches) | | | | | | | | | |
|--|--|-------------------------------|-------------------------------|-----------------------------|-----------------------------|--------------------|--------------------|------------------------------|--|
| Tape Size | D ₀ | E | P ₀ | P ₂ | T Max | T ₁ Max | | | |
| 8 mm and 12 mm | 1.5 +0.10 -0.0 (0.059 +0.004, -0.0) | 1.75 ±0.10 (0.069 ±0.004) | 4.0 ±0.10 (0.157 ±0.004) | 2.0 ±0.05 (0.079 ±0.002) | 0.600 (0.024) | 0.100 (0.004) | | | |
| Variable Dimensions — Millimeters (Inches) | | | | | | | | | |
| Tape Size | Pitch | B ₁ Max. Note 1 | D ₁ Min. Note 2 | F | P ₁ | R Min. Note 3 | T ₂ Max | W | A ₀ B ₀ K ₀ Note 4 |
| 8 mm | Single (4 mm) | 4.4 (0.173) | 1.0 (0.039) | 3.5 ±0.05 (0.138 ±0.002) | 4.0 ±0.10 (0.157 ±0.004) | 25.0 (0.984) | 2.5 (0.098) | 8.0 ±0.30 (.315 ±0.012) | |
| 12 mm | Double (8 mm) | 8.2 (0.323) | 1.5 (0.059) | 5.5 ±0.05 (0.217 ±0.002) | 8.0 ±0.10 (0.315 ±0.004) | 30.0 (1.181) | 4.6 (0.181) | 12.0 ±0.30 (0.472 ±0.012) | |

NOTES

- B1 dimension is a reference dimension for tape feeder clearance only.
- The embossment hole location shall be measured from the sprocket hole controlling the location of the embossment. Dimensions of embossment location and hole location shall be applied independent of each other.
- Tape with components shall pass around radius "R" without damage (see sketch A). The minimum trailer length (Fig. 2) may require additional length to provide R min. for 12 mm embossed tape for reels with hub diameters approaching N min. (Table 2)
- The cavity defined by A₀, B₀, and K₀ shall be configured to surround the part with sufficient clearance such that the chip does not protrude beyond the sealing plane of the cover tape, the chip can be removed from the cavity in a vertical direction without mechanical restriction, rotation of the chip is limited to 20 degrees maximum in all 3 planes, and lateral movement of the chip is restricted to 0.5 mm maximum in the pocket (not applicable to vertical clearance.)

Embossed Carrier Tape Configuration (cont.)

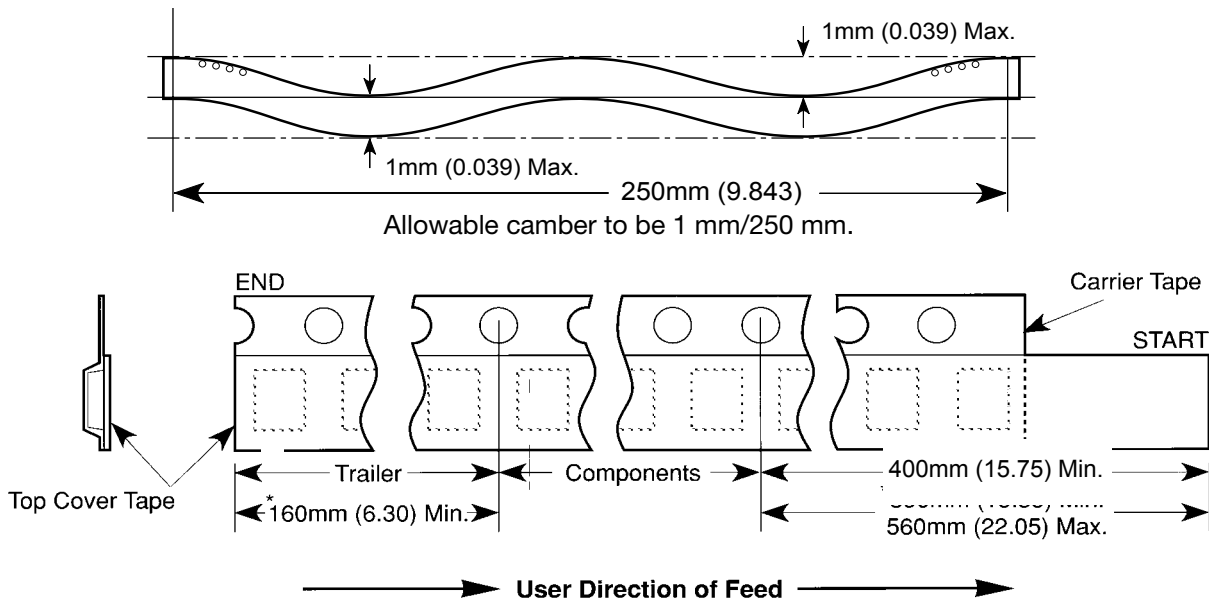
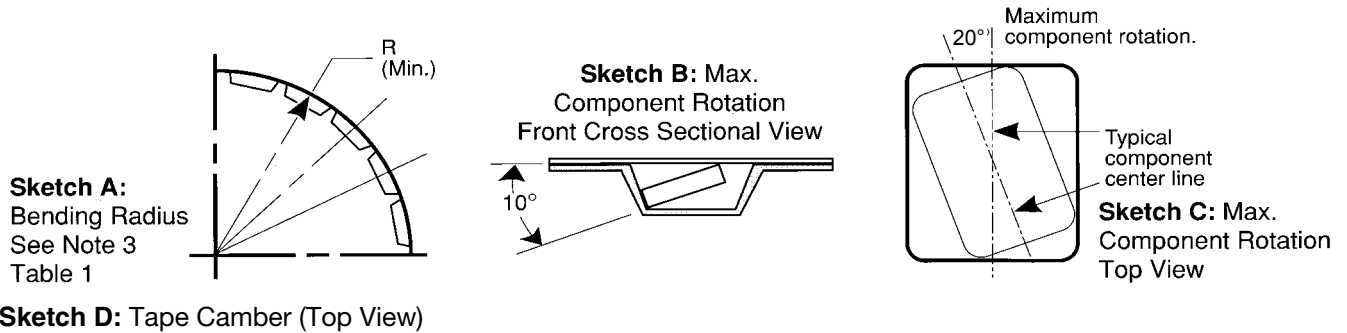

Figure 2:
Tape Leader
& Trailer
Dimensions
(Metric
Dimensions
Will Govern)

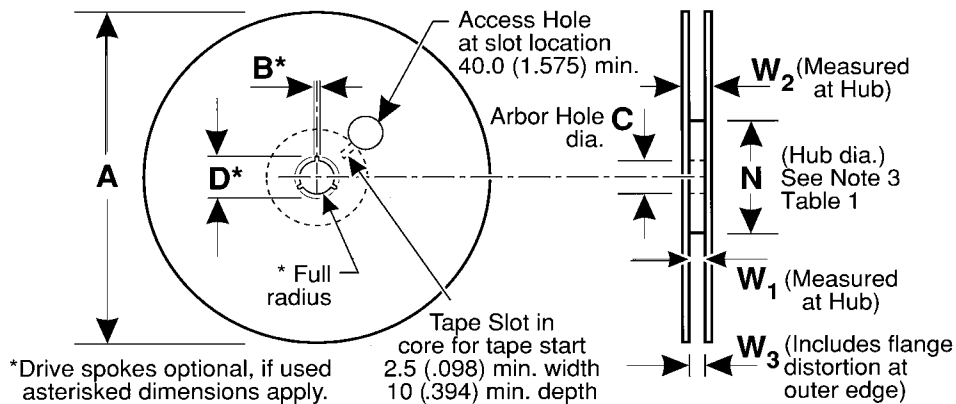

Figure 3: Reel Dimensions (Metric Dimensions will govern)

Table 2 – REEL DIMENSIONS (Metric will govern)

| Tape Size | A Max | B* Min | C | D* Min | N Min | W_1 | W_2 Max | W_3 |
|-----------|-------------------|----------------|--------------------------------|-----------------|----------------------------------|---|-----------------|--|
| 8 mm | 330.0 (12.992) | 1.5 (0.059) | 13.0 ± 0.20 (0.512 ± 0.008) | 20.2 (0.795) | 50.0 (1.969) See Note 3 | 8.4 +1.5, -0.0 (0.331 +0.059, -0.0) | 14.4 (0.567) | 7.9 Min (0.311) 10.9 Max (0.429) |
| 12 mm | 330.0 (12.992) | 1.5 (0.059) | 13.0 ± 0.20 (0.512 ± 0.008) | 20.2 (0.795) | Table 1 | 12.4 +2.0, -0.0 (0.488 +0.078, -0.0) | 18.4 (0.724) | 11.9 Min (0.469) 15.4 Max (0.606) |

Punched Carrier (Paper Tape) Configuration (Ceramic Chips Only):



Table 1: 8 & 12mm Punched Tape
(Metric Dimensions Will Govern)

Constant Dimensions - Millimeters (Inches)

| Tape Size | D ₀ | E | P ₀ | P ₂ | T ₁ | G ₁ | G ₂ | R Min. |
|--------------|--|-------------------------------|------------------------------|------------------------------|------------------------|------------------------|------------------------|------------------------------------|
| 8mm and 12mm | 1.5 +0.10, -0.0 (.059 +0.004, -0.0) | 1.75 ± 0.10 (.069 ± 0.004) | 4.0 ± 0.10 (.157 ± 0.004) | 2.0 ± 0.05 (.079 ± 0.002) | 0.10 (.004) Max. | 0.75 (.030) Min. | 0.75 (.030) Min. | 25 (.984) See Note 2 Table 1 |

Table 1: 8 & 12mm Punched Tape
(Metric Dimensions Will Govern)

Variable Dimensions - Millimeters (Inches)

| Tape Size | P ₁ | F | W | A ₀ B ₀ | T |
|-------------------------|--|-----------------------------|-----------------------------|-------------------------------|--|
| 8mm 1/2 Pitch | 2.0 ± 0.10 (.079 ± .004) See Requirements Section 3.3 (d) | 3.5 ± 0.05 (.138 ± .002) | 8.0 ± 0.3 (.315 ± 0.012) | See Note 1 Table 1 | 1.1mm (.043) Max. for Paper Base Tape and 1.6mm (.063) Max. for Non- Paper Base Compositions. See Note 3. |
| 8mm | 4.0 ± 0.10 (0.157 ± .004) | | | | |
| 12mm | 4.0 ± 0.10 (0.157 ± .004) | 5.5 ± 0.05 (.217 ± .002) | 12.0 ± 0.3 (.472 ± .012) | | |
| 12mm Double Pitch | 8.0 ± 0.10 (0.315 ± .004) | | | | |

Note:

1. A₀, B₀ and T determined by the maximum dimensions to the ends of the terminals extending from the body and/or the body dimensions of the component. The clearance between the ends of the terminals or body of the component to the sides and depth of the cavity (A₀, B₀ and T) must be within 0.05mm (.002) minimum and 0.50mm (.020) maximum. The clearance allowed must also prevent rotation of the component within the cavity of not more than 20 degrees (see sketches A and B).
2. Tape with components shall pass around radius "R" without damage.
3. KEMET nominal thicknesses are: 0402 = 0.6mm and all others 0.95mm minimum.

Sketch A:
Bending Radius
See Note 2
Table 1

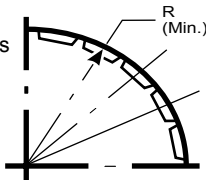

Sketch B:
Max. Component
Rotation - Front
Cross Sectional View



Sketch C:
Component Rotation - Top View



Bulk Cassette Packaging (Ceramic Chips only) (Meets Dimensional Requirements IEC-286-6 and EIAJ 7201)

Table 2 – Capacitance Values Available In Bulk Cassette Packaging



| Case Size | Dielectric | Voltage | Min. Cap Value | Max. Cap Value |
|-----------|------------|---------|----------------|----------------|
| 0402 | All | All | All | All |
| 0603 | All | All | All | All |
| 0805 | C0G | 200 | 109 | 181 |
| | | 100 | 109 | 331 |
| | X7R | 200 | 221 | 392 |
| | | 100 | 221 | 103 |
| | | 50 | 221 | 273 |
| | | 25 | 221 | 104 |
| | | 16 | 221 | 104 |
| | Y5V | 25 | 104 | 224 |
| | | 16 | 104 | 224 |

Table 1 – Capacitor Dimensions for Bulk Cassette Packaging – Millimeters

| Metric Size Code | EIA Size Code | Length L | Width W | Thickness T | Bandwidth B | Minimum Separation S | Number of Pcs/Cassette |
|------------------|---------------|------------|-------------|-------------|-------------|----------------------|------------------------|
| 1005 | 0402 | 1.0 ± 0.05 | 0.5 ± 0.05 | 0.5 ± .05 | 0.2 to 0.4 | 0.3 | 50,000 |
| 1608 | 0603 | 1.6 ± 0.07 | 0.8 ± 0.07 | 0.8 ± .07 | 0.2 to 0.5 | 0.7 | 15,000 |
| 2012 | 0805 | 2.0 ± 0.10 | 1.25 ± 0.10 | 0.6 ± .10 | 0.5 to 0.75 | 0.75 | 10,000 |

Terminations: KEMET nickel barrier layer with a tin overplate.

CAPACITOR MARKING TABLE (Marking Optional - Not Available for 0402 Size or Y5V Dielectric)

| Alpha Character | Capacitance (pF) For Various Numerical Identifiers | | | | | | | | |
|-----------------|--|-----|----|-----|------|--------|---------|-----------|------------|
| | 9 | 0 | 1 | 2 | 3 | 4 | 5 | 6 | 7 |
| A | 0.10 | 1.0 | 10 | 100 | 1000 | 10,000 | 100,000 | 1,000,000 | 10,000,000 |
| B | 0.11 | 1.1 | 11 | 110 | 1100 | 11,000 | 110,000 | 1,100,000 | 11,000,000 |
| C | 0.12 | 1.2 | 12 | 120 | 1200 | 12,000 | 120,000 | 1,200,000 | 12,000,000 |
| D | 0.13 | 1.3 | 13 | 130 | 1300 | 13,000 | 130,000 | 1,300,000 | 13,000,000 |
| E | 0.15 | 1.5 | 15 | 150 | 1500 | 15,000 | 150,000 | 1,500,000 | 15,000,000 |
| F | 0.16 | 1.6 | 16 | 160 | 1600 | 16,000 | 160,000 | 1,600,000 | 16,000,000 |
| G | 0.18 | 1.8 | 18 | 180 | 1800 | 18,000 | 180,000 | 1,800,000 | 18,000,000 |
| H | 0.20 | 2.0 | 20 | 200 | 2000 | 20,000 | 200,000 | 2,000,000 | 20,000,000 |
| J | 0.22 | 2.2 | 22 | 220 | 2200 | 22,000 | 220,000 | 2,200,000 | 22,000,000 |
| K | 0.24 | 2.4 | 24 | 240 | 2400 | 24,000 | 240,000 | 2,400,000 | 24,000,000 |
| L | 0.27 | 2.7 | 27 | 270 | 2700 | 27,000 | 270,000 | 2,700,000 | 27,000,000 |
| M | 0.30 | 3.0 | 30 | 300 | 3000 | 30,000 | 300,000 | 3,000,000 | 30,000,000 |
| N | 0.33 | 3.3 | 33 | 330 | 3300 | 33,000 | 330,000 | 3,300,000 | 33,000,000 |
| P | 0.36 | 3.6 | 36 | 360 | 3600 | 36,000 | 360,000 | 3,600,000 | 36,000,000 |
| Q | 0.39 | 3.9 | 39 | 390 | 3900 | 39,000 | 390,000 | 3,900,000 | 39,000,000 |
| R | 0.43 | 4.3 | 43 | 430 | 4300 | 43,000 | 430,000 | 4,300,000 | 43,000,000 |
| S | 0.47 | 4.7 | 47 | 470 | 4700 | 47,000 | 470,000 | 4,700,000 | 47,000,000 |
| T | 0.51 | 5.1 | 51 | 510 | 5100 | 51,000 | 510,000 | 5,100,000 | 51,000,000 |
| U | 0.56 | 5.6 | 56 | 560 | 5600 | 56,000 | 560,000 | 5,600,000 | 56,000,000 |
| V | 0.62 | 6.2 | 62 | 620 | 6200 | 62,000 | 620,000 | 6,200,000 | 62,000,000 |
| W | 0.68 | 6.8 | 68 | 680 | 6800 | 68,000 | 680,000 | 6,800,000 | 68,000,000 |
| X | 0.75 | 7.5 | 75 | 750 | 7500 | 75,000 | 750,000 | 7,500,000 | 75,000,000 |
| Y | 0.82 | 8.2 | 82 | 820 | 8200 | 82,000 | 820,000 | 8,200,000 | 82,000,000 |
| Z | 0.91 | 9.1 | 91 | 910 | 9100 | 91,000 | 910,000 | 9,100,000 | 91,000,000 |
| a | 0.25 | 2.5 | 25 | 250 | 2500 | 25,000 | 250,000 | 2,500,000 | 25,000,000 |
| b | 0.35 | 3.5 | 35 | 350 | 3500 | 35,000 | 350,000 | 3,500,000 | 35,000,000 |
| d | 0.40 | 4.0 | 40 | 400 | 4000 | 40,000 | 400,000 | 4,000,000 | 40,000,000 |
| e | 0.45 | 4.5 | 45 | 450 | 4500 | 45,000 | 450,000 | 4,500,000 | 45,000,000 |
| f | 0.50 | 5.0 | 50 | 500 | 5000 | 50,000 | 500,000 | 5,000,000 | 50,000,000 |
| m | 0.60 | 6.0 | 60 | 600 | 6000 | 60,000 | 600,000 | 6,000,000 | 60,000,000 |
| n | 0.70 | 7.0 | 70 | 700 | 7000 | 70,000 | 700,000 | 7,000,000 | 70,000,000 |
| t | 0.80 | 8.0 | 80 | 800 | 8000 | 80,000 | 800,000 | 8,000,000 | 80,000,000 |
| y | 0.90 | 9.0 | 90 | 900 | 9000 | 90,000 | 900,000 | 9,000,000 | 90,000,000 |

Laser marking is available as an extra-cost option for most KEMET ceramic chips. Such marking is two sided, and includes a \bar{K} to identify KEMET, followed by two characters (per EIA-198 - see table below) to identify the capacitance value. Note that marking is not available for size 0402 nor for any Y5V chip. In addition, the 0603 marking option is limited to the \bar{K} only.



Example shown is 1,000 pF capacitor.