

ENG. NO. SD-5547-NA

EDP NO.

MM DIMENSIONS IN METRIC DO NOT SCALE DRAWING

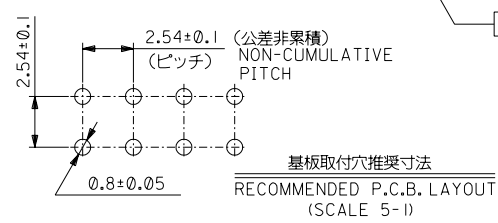
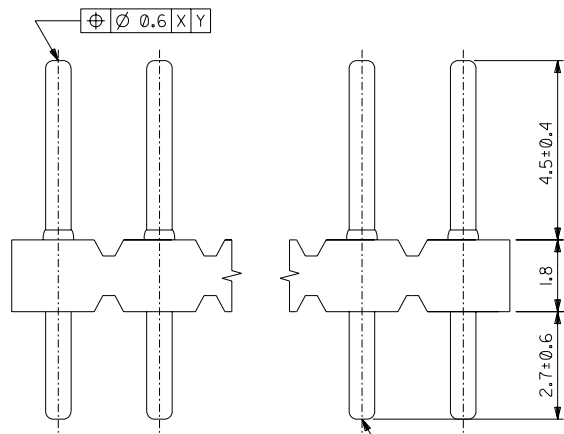
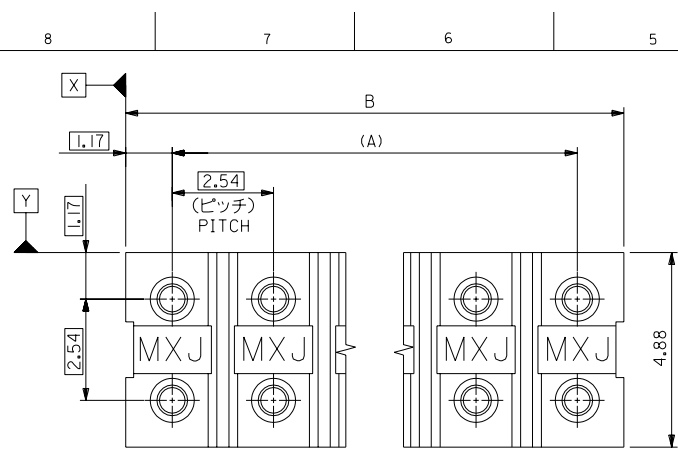

注記:
NOTES

1. 材料
MATERIAL
ピン : 黄銅 $\phi 0.64$
PIN : BRASS $\phi 0.64$
ウェハー : ガラス15%入りP.B.T. UL94V-0、黒
WAFER : P.B.T. G.F.15% UL94V-0, BLACK
2. メッキ仕様
PLATING
錫メッキ
Sn PLATING.
3. 2極は5547-NAを切断加工したものです。
2 CIRCUITS TO BE MADE BY CUTTING
5547-NA.

42.98	40.64	5547-34A	34
40.44	38.10	5547-32A	32
37.90	35.56	5547-30A	30
35.36	33.02	5547-28A	28
32.82	30.48	5547-26A	26
30.28	27.94	5547-24A	24
27.74	25.40	5547-22A	22
25.20	22.86	5547-20A	20
22.66	20.32	5547-18A	18
20.12	17.78	5547-16A	16
17.58	15.24	5547-14A	14
15.04	12.70	5547-12A	12
12.50	10.16	5547-10A	10
9.96	7.62	5547-08A	8
7.42	5.08	5547-06A	6
4.88	2.54	5547-04A	4
2.54 $\begin{smallmatrix} +0.5 \\ -0.2 \end{smallmatrix}$	—	5547-02A	2
B	(A)	ENG. No.	CKT.

角度 ANGLE	$\pm 3^\circ$	材料 MATERIAL	注記参照 SEE NOTES	MOLEX MOLEX-JAPAN CO.,LTD. 日本モレックス株式会社
30以上 OVER	± 0.5	仕上げ FINISH	注記参照 SEE NOTES	
10以上 30未満 UNDER	± 0.25	適用電線範囲 WIRE RANGE	—	EDP NO. —
10未満 UNDER	± 0.2	被覆外径 INS. RANGE	—	ENG. NO. (SHEET 1 OF 2) REV B
一般公差 UNIT:mm GENERAL TOLERANCES	REVISION RECORD	DR. CHK. DATE	APPR'D BY	TITLE 名称 2.54 DUAL ROW MICRO SHUNT WAFER ASS'Y

THIS DRAWING CONTAINS INFORMATION THAT IS PROPRIETARY TO MOLEX/JAPAN AND SHOULD NOT BE USED WITHOUT WRITTEN PERMISSION
本図面は日本モレックス(株)の所有する情報を含むもので 当社の許可なく複製を禁止する。 MXJ-B

DWG. NO. SD-5547-NA
 DIMENSIONS IN METRIC DO NOT SCALE DRAWING

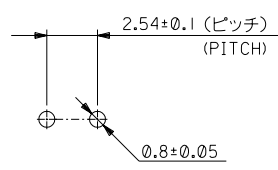
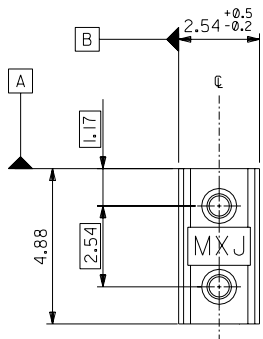
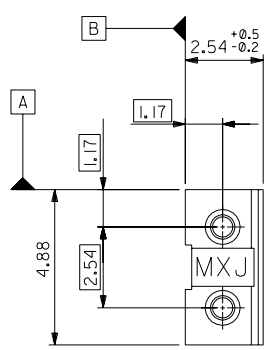

基板取付穴推奨寸法
 RECOMMENDED P.C.B. LAYOUT
 (SCALE: 5-1)

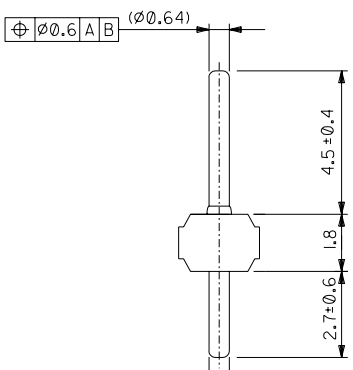
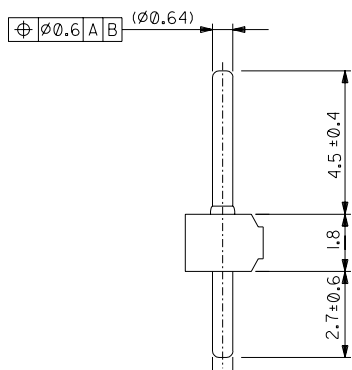

TYPE I

TYPE II

材料 MATERIAL	注記参照 SEE NOTES	MOLEX-JAPAN CO.,LTD. 日本モレックス株式会社
仕上げ FINISH	注記参照 SEE NOTES	REVISE ONLY ON CAD SYSTEM
適用電線範囲 WIRE RANGE	---	TITLE 名称
被覆外径 INS. RANGE	---	2.54 DUAL ROW
DRAWN BY 36/12/13 K. Adachi	CHK'D BY H. Sato	MICRO SHUNT WAFER ASS'Y
APP'D BY S. Yamaguchi	尺度 SCALE 8-1	DWG. NO. (SHEET 2 OF 2) REV SD-5547-NA B
角度 ANGLE ±3°		
30 以上 OVER ±0.3		
10 以上 30 未満 OVER UNDER ±0.25		
10 未満 UNDER ±0.2		
一般公差 GENERAL TOLERANCES	記号 LTR 変更内容 REVISION RECORD	DR. 日付 DATE

THIS DRAWING CONTAINS INFORMATION THAT IS PROPRIETARY TO MOLEX/JAPAN AND SHOULD NOT BE USED WITHOUT WRITTEN PERMISSION
 本図面は日本モレックス(株)の所有する情報を含むもので 当社の許可なく複製を禁止する。 EN-01C(032)MXJ-32