

10 9 8 7 6 5 4 3 2 1

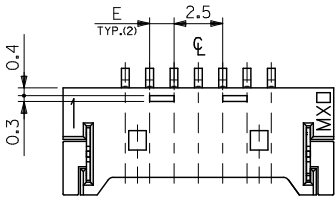

7~19極の奇数極に適用
APPLY FOR ODD CIRCUITS OF 7~19

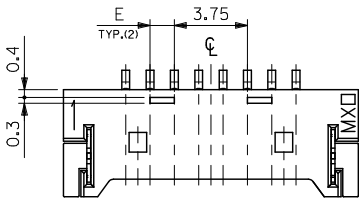

8~30極の偶数極に適用
APPLY FOR EVEN CIRCUITS OF 8~30

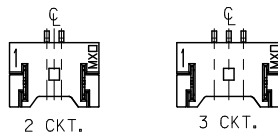

ロック形状図
LOCK CONFIGURATION

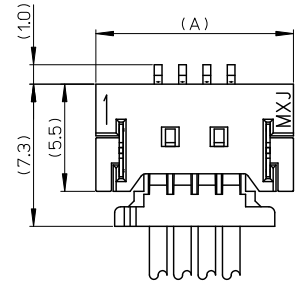

嵌合図 (SCALE 5:1)
MATED CONNECTORS (SCALE 5:1)

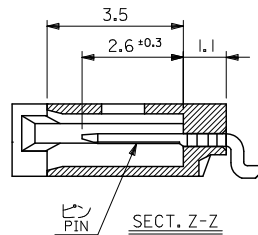

SECT. Z-Z
PIN

CONNECTOR SERIES NO. 53780-***19

REVISED EC NO: J2010-1927 DRAWN BY: T. DRWNSKUROSE CHKD BY: CHYKOKASAKANA APPR: NIKITA DATE: 2010/03/25 2010/03/26 2010/03/29	GENERAL TOLERANCES (UNLESS SPECIFIED)		DIMENSION STYLE MM ONLY		SCALE ---	DESIGN UNITS METRIC	THIRD ANGLE PROJECTION
	10 UNDER	±0.2	DRAWN BY T. UENO	DATE '04/04/15	TITLE 1.25 W/B CONN WAFER ASSY FOR SMT		
	10 OVER 30 UNDER	±0.25	CHECKED BY M. SASAO	DATE '04/04/15			
	30 OVER	±0.3	APPROVED BY M. SASAO	DATE '04/04/15	MOLEX INCORPORATED		
ANGULAR	±3 °	MATERIAL NO. SEE CHART	DOCUMENT NO. SD-53780-003	SHEET NO. 2 OF 2			
DRAFT WHERE APPLICABLE MUST REMAIN WITHIN DIMENSIONS			THIS DRAWING CONTAINS INFORMATION THAT IS PROPRIETARY TO MOLEX INCORPORATED AND SHOULD NOT BE USED WITHOUT WRITTEN PERMISSION				

10 9 8 7 6 5 4 3 2 1

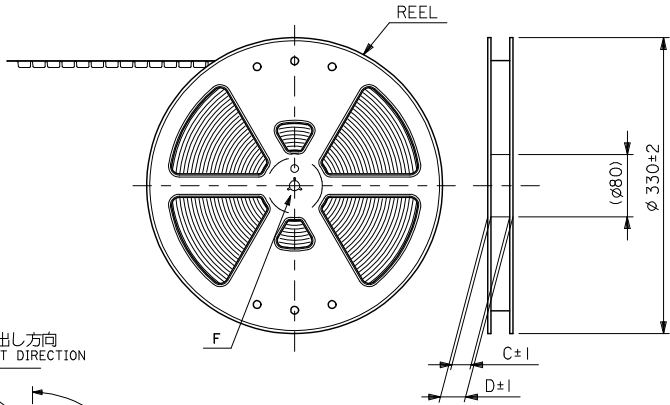
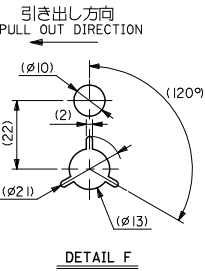

NOTES

1. 梱包数量：1500個/リール
NUMBER OF CONNECTORS : 1500PCS/REEL
2. リードテープ長さ LEAD TAPE LENGTH

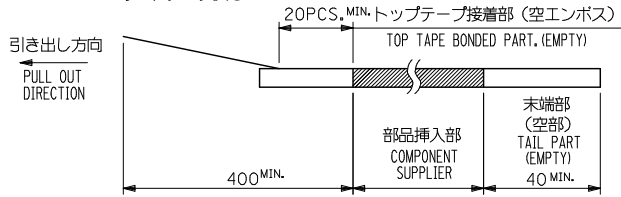

3. トップテープの剥離強度：0.1N ~ 1.3N (10gf ~ 130gf)
(剥離方向は下図参照)
尚、本規格値は出荷時に適用。(但し、輸送時に剥離が発生しないこと。)
PEELING OFF FORCE OF TOP TAPE : 0.1N ~ 1.3N (10gf ~ 130gf)
(PEELING DIRECTION AS SHOWN IN FOLLOWING FIG.)
THIS REQUIREMENT SHOULD BE APPLIED AT SHIPMENT.
PEEL OFF SHOULD NOT BE ALLOWED, DURING TRANSPORTATION.

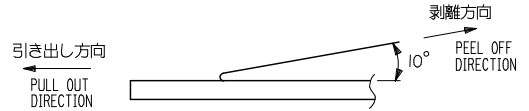

4. 材料 (MATERIAL)
キャリアテープ (CARRIER TAPE) : ポリプロピレン (POLYPROPYLENE)
トップテープ (TOP TAPE) : PET, PE, PEF
リール (REEL) : ポリスチレン (PS) <リサイクル材を含む>
POLYSTYRENE (PS) <RECYCLE MATERIAL CONTAINED>
5. 本製品は 53780-**90/-**80 の鉛フリー品である。
THIS PRODUCT IS LEAD FREE OF 53780-**90/-**80.
6. ELV及びRoHS適合品
ELV & RoHS COMPLIANT

MODEL NO. 53780-**70

REVISED EC NO: J2010-0021 DRAWN: TAKASAKI 2009/07/07 CHKD: HAYASHI 2009/07/08 APPR: NIKITA 2009/07/08	GENERAL TOLERANCES (UNLESS SPECIFIED)		DIMENSION STYLE MM ONLY	SCALE ---	DESIGN UNITS METRIC	THIRD ANGLE PROJECTION
	10 UNDER	±0.2	DRAWN BY T. UENO	DATE '04/04/15	TITLE 1.25 W/B WAFER ASSY EMBOSSSED TAPE PACKAGE	
	10 OVER 30 UNDER	±0.25	CHECKED BY M. SASAO	DATE '04/04/15	MOLEX INCORPORATED	
	30 OVER	±0.3	APPROVED BY M. SASAO	DATE '04/04/15	MATERIAL NO. SEE CHART	DOCUMENT NO. SD-53780-004
ANGULAR ±3°			THIS DRAWING CONTAINS INFORMATION THAT IS PROPRIETARY TO MOLEX INCORPORATED AND SHOULD NOT BE USED WITHOUT WRITTEN PERMISSION			
DRAFT WHERE APPLICABLE MUST REMAIN WITHIN DIMENSIONS						

10 9 8 7 6 5 4 3 2 1

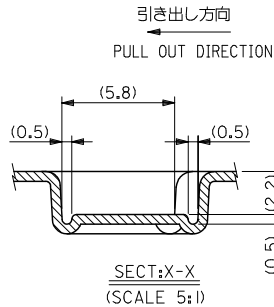
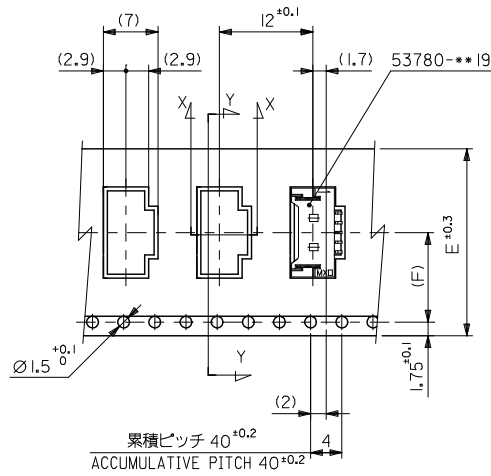
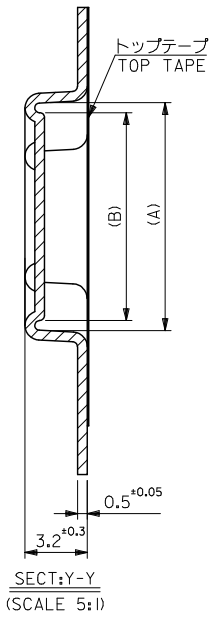

11.5	24	29.4	25.4	11.75	16.7	53780-0970	9
				10.5	15.45	53780-0870	8
				9.25	14.2	53780-0770	7
				8	12.95	53780-0670	6
				6.75	11.7	53780-0570	5
7.5	16	21.4	17.4	5.5	10.45	53780-0470	4
				4.25	9.2	53780-0370	3
(F)	E	D	C	(B)	(A)	MATERIAL NO.	搬入 CKT.

REVISED E.C. NO: J2010-0021 DRAWN BY: DRWNHTAKASAKI CHECKED BY: CHYKDMHAYASHI APPROVED BY: APPRPNIKITA DATE: 2009/07/07 DATE: 2009/07/08 DATE: 2009/07/08	GENERAL TOLERANCES (UNLESS SPECIFIED)		DIMENSION STYLE MM ONLY		SCALE ---	DESIGN UNITS METRIC	THIRD ANGLE PROJECTION
	10 UNDER	±0.2	DRAWN BY T. UENO	DATE '04/04/15	TITLE 1.25 W/B WAFER ASSY EMBOSSD TAPE PACKAGE		
	10 OVER 30 UNDER	±0.25	CHECKED BY M. SASAO	DATE '04/04/15	MOLEX INCORPORATED		
	30 OVER	±0.3	APPROVED BY M. SASAO	DATE '04/04/15	MATERIAL NO. SEE CHART DOCUMENT NO. SD-53780-004 SHEET NO. 2 OF 3		
ANGULAR ±3°		DRAFT WHERE APPLICABLE MUST REMAIN WITHIN DIMENSIONS		THIS DRAWING CONTAINS INFORMATION THAT IS PROPRIETARY TO MOLEX INCORPORATED AND SHOULD NOT BE USED WITHOUT WRITTEN PERMISSION			

10 9 8 7 6 5 4 3 2 1

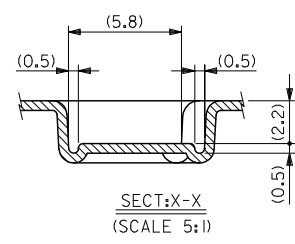
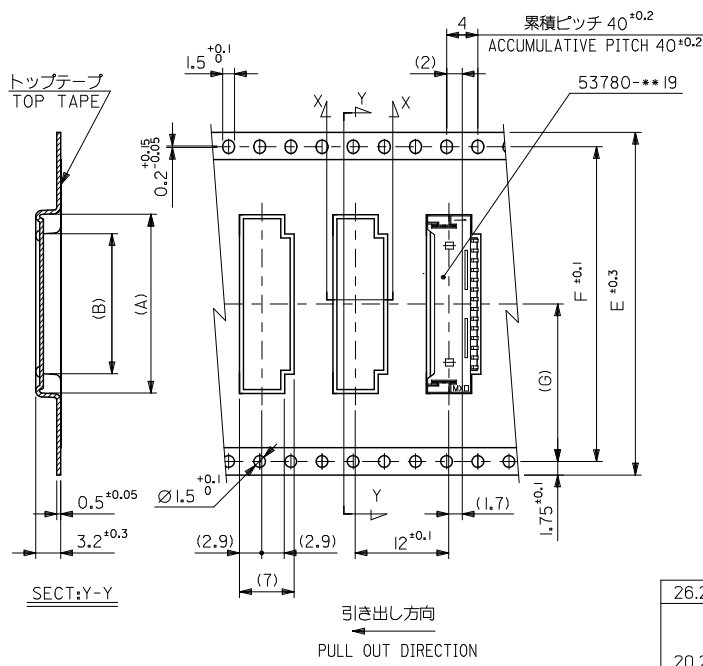

26.2	52.4	56	61.4	57.4	38	42.95	53780-3070	30
					25.5	30.45	53780-2070	20
					25.5	27.95	53780-1870	18
					19.25	24.2	53780-1570	15
					18	22.95	53780-1470	14
					15.5	20.45	53780-1270	12
					14.2	28.4	53780-1070	10
(G)	F	E キャリアテープ幅 CARRIER TAPE WIDTH	D	C	(B)	(A)	MATERIAL NO.	数量 QTY.

REVISED E.C. NO: J2010-0021 DRAWN: AKASAKI 2009/07/07 CHYKOHAYASHI 2009/07/08 APPR: NIKITA 2009/07/08	GENERAL TOLERANCES (UNLESS SPECIFIED)		DIMENSION STYLE MM ONLY		SCALE ---	DESIGN UNITS METRIC	MODEL NO. 53780-***70	
	10 UNDER	±0.2	DRAWN BY T. UENO	DATE '04/04/15	TITLE 1.25 W/B WAFER ASSY EMBOSSED TAPE PACKAGE			
	10 OVER 30 UNDER	±0.25	CHECKED BY M. SASAO	DATE '04/04/15	THIRD ANGLE PROJECTION			
	30 OVER	±0.3	APPROVED BY M. SASAO	DATE '04/04/15	MOLEX INCORPORATED			
ANGULAR ±3 °		DRAFT WHERE APPLICABLE MUST REMAIN WITHIN DIMENSIONS		MATERIAL NO. SEE CHART	DOCUMENT NO. SD-53780-004	SHEET NO. 3 OF 3		
THIS DRAWING CONTAINS INFORMATION THAT IS PROPRIETARY TO MOLEX INCORPORATED AND SHOULD NOT BE USED WITHOUT WRITTEN PERMISSION								