

4

3

2

1

THIS DRAWING IS UNPUBLISHED. RELEASED FOR PUBLICATION .19
 (C) COPYRIGHT 19 BY AMP INCORPORATED, ALL RIGHTS RESERVED.

REVISONS		DESCRIPTION	ECN	DATE	DWN	APVD
P	LYR					
0		作成 (RELEASED)	FJ00-1109-97	30JUL97	K.F	K.S
A		変更 (REVISED)	FJ00-085B-99	18MAY99	K.F	K.O

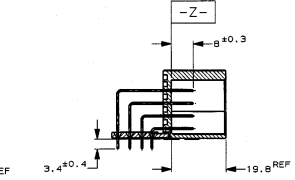
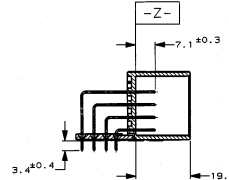
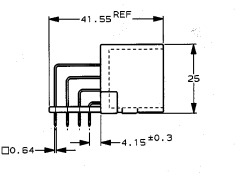
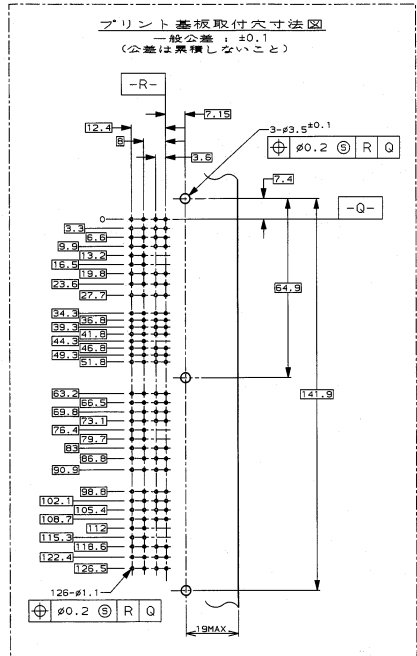
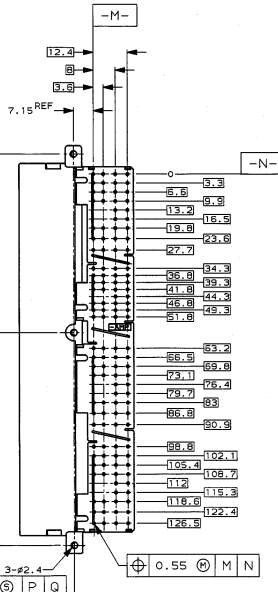
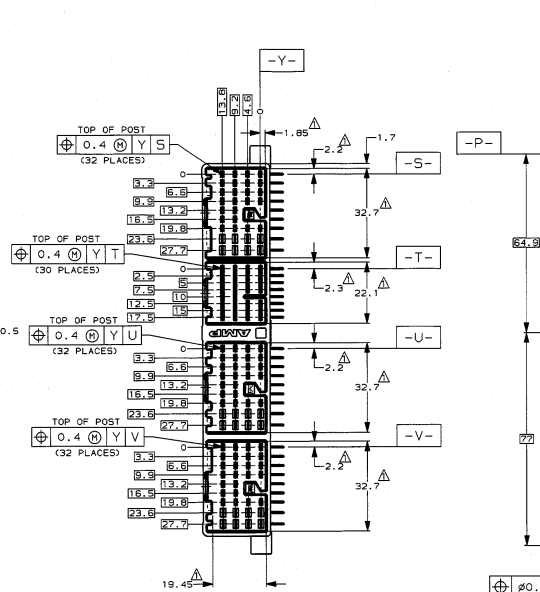
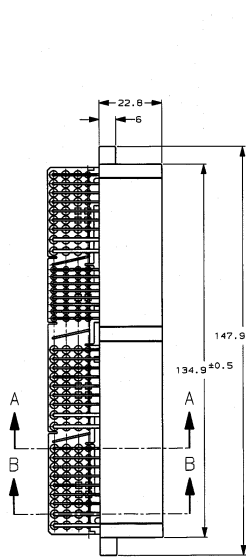

注記
 1 [Z] 面より8.5mmの位置で測定
 2 挿入取付ねじ: JIS B1115, B1122 ツツねじ, 全ねじ
 呼び径3, 長さ8mm以下 (挿付トルク: 0.4N.m (4kg-cm) 以下)
 NOTE
 1 MEASURED AT THE SECTION B, 5mm FROM [Z]
 2 RECOMMENDED SCREW: PAN-HEADED, TYPE 2 TAPPING SCREW
 OF 3D1A X BLEND (JIS B1115, B1122)
 (FASTENING TORQUE FOR SCREW: 0.4N.m (4kg-cm) MAX)

① 銀パール	GRAY 灰色	1-353222-6
② 通孔	GRAY 灰色	353222-6
③ 挿入取付ねじ	HOUSING COLOR ハウジング色	P/N

AMP K. ODA K. SHIMIZU
 AMP 12996, CAP HOUSING ASS'Y, .0401/.0703 HD HYBRID I/O CONN.
 12996 銀メッキハウジングアッシー
 .0401/.0703 HD ハイブリット I/O コネクタ
 .040X1.02mm .070X24mm
 SIZE CASE CODE DESCRIPTION NO.
 54.3g A2 00779 ©=353222
 CUSTOMER DRAWING SHEET 1 OF 1 REV A