

REV		REVISIONS			
NO	DATE	DESCRIPTION	BY	CHK	APP
00					
C4		REVISED PER ECO-10-000160	JUNH08	DCS	

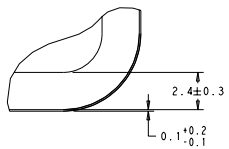

DETAIL B
SCALE 8:1

- △ ACCEPTS #4 SELF TAPPING THREAD CUTTING SCREWS OR METRIC EQUIVALENT. DRIVE TO 0.6 N-m MAX
- △ DATE CODE IN THIS LOCATION USING 5 DIGIT CODE
FIRST 2 DIGITS = YEAR, SECOND 2 DIGITS = WEEK
LAST DIGIT = DAY.
- △ MATERIALS: HEADER HOUSING - GLASS FILLED PBT
PINS - TIN OR GOLD PLATED BRASS
GASKET - SILICONE
- △ HOUSING COLORS ARE MECHANICALLY KEYS TO MATE ONLY WITH IDENTICALLY COLORED PLUG ASSEMBLIES.
- 5. HEADER MATES TO PLUG ASSEMBLY 770680 WHICH USES REELED TERMINAL 770520 OR LOOSE PIECE TERMINAL 770854

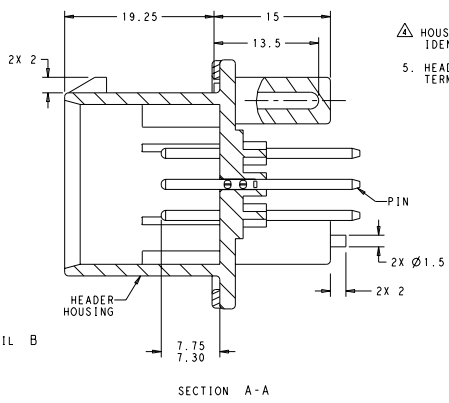
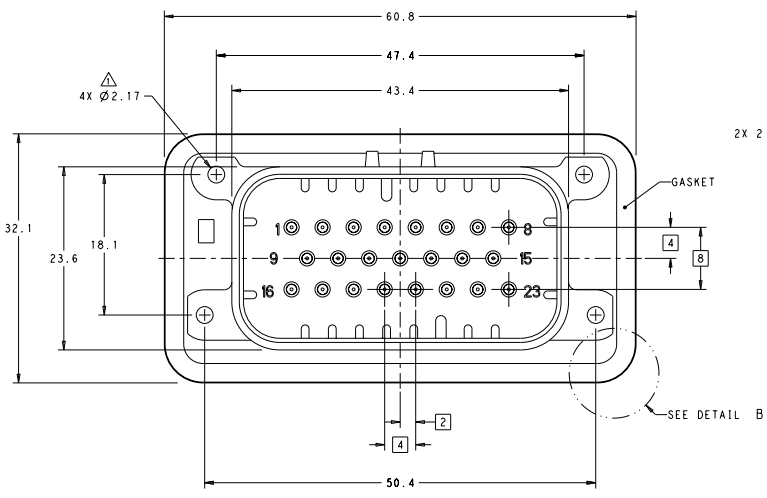
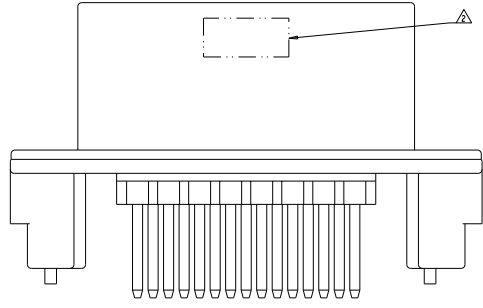

776228-1 & 1-776228-1 SHOWN

HEADER COLOR	PLATING	PART NUMBER
BLUE	DURAGOLD	1-776228-5
GRAY	DURAGOLD	1-776228-4
NATURAL	DURAGOLD	1-776228-2
BLACK	DURAGOLD	1-776228-1
BLUE	TIN	776228-5
GRAY	TIN	776228-4
NATURAL	TIN	776228-2
BLACK	TIN	776228-1

STRASSER 100-1329 116-18016 CUSTOMER DRAWING	STRASSER 100-1329 116-18016 CUSTOMER DRAWING	ASSEMBLY - HEADER 23 POSITION, VERTICAL WITH FLANGE SEAL	DATE: 00779 PART: 776228 SCALE: 4:1 SHEET: 1 OF 2
-------------------------------------------------------	-------------------------------------------------------	----------------------------------------------------------------	------------------------------------------------------------

REV	BY	DATE	DESCRIPTION	APP'D	CHK'D
00			SEE SHEET 1		

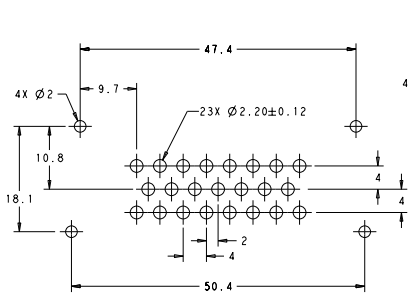

RECOMMENDED P.C. BOARD LAYOUT FOR 1.57 THICK P.C. BOARD

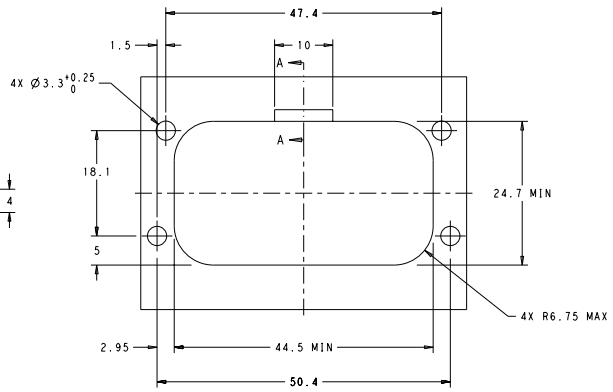

RECOMMENDED MOUNTING HOLE LAYOUT FOR 5.0 MAX THICK PANEL

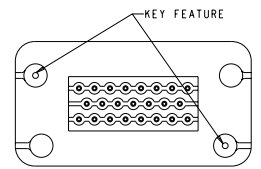

KEYING FOR 776228-1 AND 776228-5 SCALE 2:1

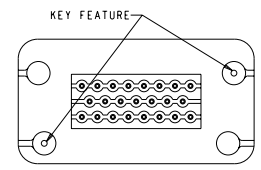

KEYING FOR 776228-2 AND 776228-4 SCALE 2:1

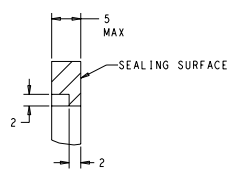

SECTION A-A OPTIONAL CONSTRUCTION IF PANEL THICKNESS IS GREATER THAN 2.0

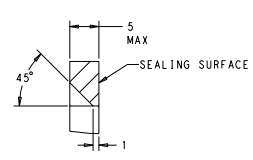

SECTION A-A OPTIONAL CONSTRUCTION IF PANEL THICKNESS IS GREATER THAN 2.0

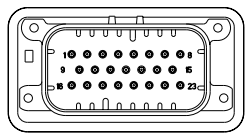

776228-2 & 1-776228-2 KEY LOCATION SCALE 2:1

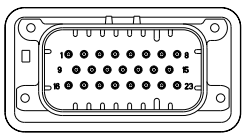

776228-4 & 1-776228-4 KEY LOCATION SCALE 2:1

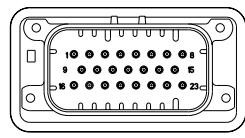

776228-5 & 1-776228-5 KEY LOCATION SCALE 2:1

STRASSER 100-1329 116-18016 00779		STRASSER 100-1329 116-18016 00779		ASSEMBLY - HEADER 23 POSITION, VERTICAL WITH FLANGE SEAL	
CUSTOMER DRAWING		SCALE CODE (DRAWING NO)		DRAWN BY	
DATE		SHEET		TOTAL SHEETS	