

CKT SIZE	DIM A	DIM B
4	.709 (18.00)	.496 (12.60)
5	.874 (22.20)	.661 (16.80)
6	1.039 (26.40)	.827 (21.00)
7	1.205 (30.60)	.992 (25.20)
8	1.370 (34.80)	1.157 (29.40)
9	1.535 (39.00)	1.323 (33.60)
10	1.701 (43.20)	1.488 (37.80)
11	1.866 (47.40)	1.654 (42.00)
12	2.031 (51.60)	1.819 (46.20)

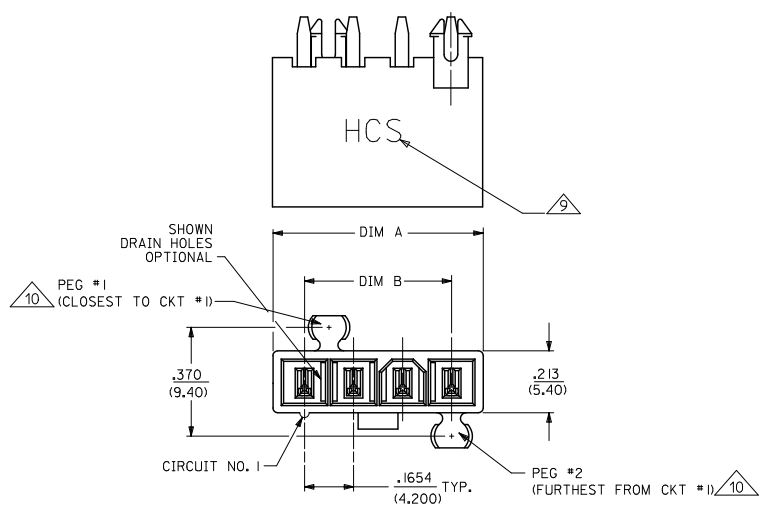

- NOTES:
- MATERIALS:
HOUSING:
1=NYLON 6/6, UL94 V-2, COLOR: NATURAL
2=NYLON 6/6, UL94 V-0, COLOR: NATURAL
3=NYLON 6/6, UL94 V-2, COLOR: BLACK
TERMINALS:
COPPER ALLOY
 - TERMINAL PLATING:
1=.000100/(0.00254) MIN. BRIGHT TIN OVER
.000050/(0.00127) MIN. NICKEL
2=.000030/(0.00076) MIN. SELECT GOLD AND
.000100/(0.00254) MIN. SELECT MATTE TIN
OVER .000050/(0.00127) MIN. NICKEL OVERALL
3=.000100/(0.00254) MIN. MATTE TIN OVER
.000050/(0.00127) MIN. NICKEL
 - PRODUCT SPECIFICATION: PS-44476-001
 - PACKAGING: SEE CHARTS
 - PART MATES WITH MINI-FIT JR. RECEPTACLE NO. 5557.
 - PART IS NOT DESIGNED FOR CURRENT SHARING.
 - PARTS ARE NOT TO BE MATED OR UN-MATED WHILE CIRCUITS ARE LIVE.
 - 44472-2470 ONLY FOR WIDER LOCKING RAMP.
 - PARTS WILL HAVE "HCS" MARKING.
 - SEE CHART FOR PARTS WITH PEGS REMOVED.
 - PART CONFORMS TO CLASS 'B' REQUIREMENTS OF COSMETIC SPECIFICATION PS-45499-002.

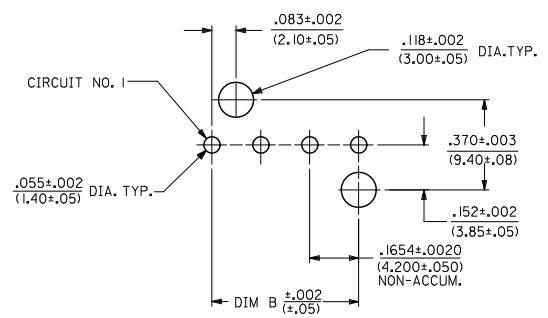
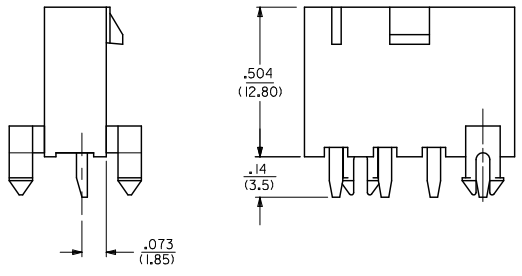

RECOMMENDED HOLE LAYOUT FOR
.070/(1.78) MAX. THICK P. C. BOARD
VIEWED FROM COMPONENT SIDE

LEGEND:
44472 - ** **
CIRCUIT SIZE
(04-12 FOR SINGLE ROW)
(02-24 FOR DUAL ROW)
ASSEMBLY VERSION
(01 THRU 49 FOR SINGLE ROW)
(50 THRU 99 FOR DUAL ROW)

SEE SHT. 2 FOR DUAL ROW
* THE CHART FOR SINGLE ROW PRODUCT IS ON PAGE 6.

CHG PK SPEC EC NO: UEP2011-0640 DRAWN: JAGUILAR 20/01/16 CHKD: BEL 20/01/16 APPR: SMITH 20/01/16	QUALITY SYMBOLS ▽=0 ▽=0 ▽=0	GENERAL TOLERANCES (UNLESS SPECIFIED)	DIMENSION STYLE IN/MM	SCALE 4:1	DESIGN UNITS METRIC	THIRD ANGLE PROJECTION
		4 PLACES ± --- ± --- 3 PLACES ± --- ± .015 2 PLACES ± 0.38 ± .020 1 PLACE ± 0.50 ± --- ANGULAR ±1/2°	DRAWN BY GEP 1994/07/25	DATE 1994/07/25	TITLE MINI-FIT VERT HDR ASSY W & W/O PEGS/DRAIN HOLES SINGLE AND DUAL ROW	MATERIAL NO. SDA-44472-****
DRAFT WHERE APPLICABLE MUST REMAIN WITHIN DIMENSIONS		SEE CHARTS		THIS DRAWING CONTAINS INFORMATION THAT IS PROPRIETARY TO MOLEX INCORPORATED AND SHOULD NOT BE USED WITHOUT WRITTEN PERMISSION		

13 12 11 10 9 8 7 6 5 4 3 2 1

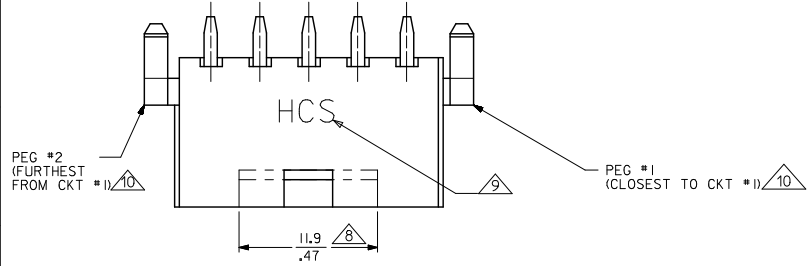

CIRCUIT SIZE	DIM. "A"	DIM. "B"	DIM. "C"
2	.21 (5.4)	—	.370 (9.40)
4	.38 (9.6)	.17 (4.2)	.535 (13.6)
6	.54 (13.8)	.33 (8.4)	.701 (17.8)
8	.71 (18.0)	.50 (12.6)	.866 (22.0)
10	.87 (22.2)	.66 (16.8)	1.031 (26.2)
12	1.04 (26.4)	.83 (21.0)	1.197 (30.4)
14	1.20 (30.6)	.99 (25.2)	1.362 (34.6)
16	1.37 (34.8)	1.16 (29.4)	1.528 (38.8)
18	1.54 (39.0)	1.32 (33.6)	1.693 (43.0)
20	1.70 (43.2)	1.49 (37.8)	1.858 (47.2)
22	1.87 (47.4)	1.65 (42.0)	2.024 (51.4)
24	2.03 (51.6)	1.82 (46.2)	2.189 (55.6)

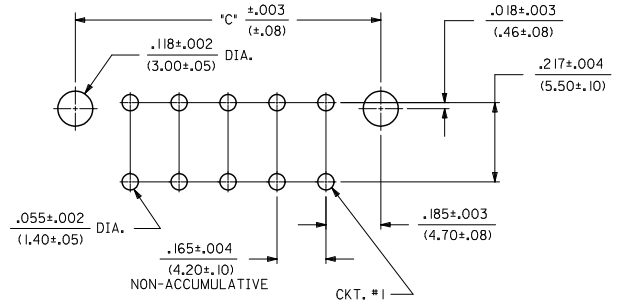
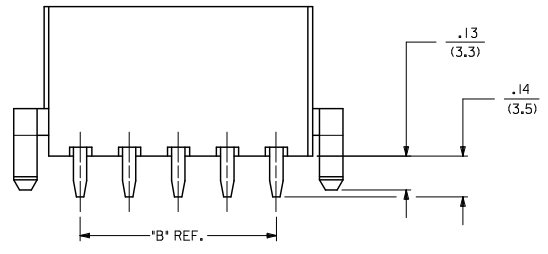
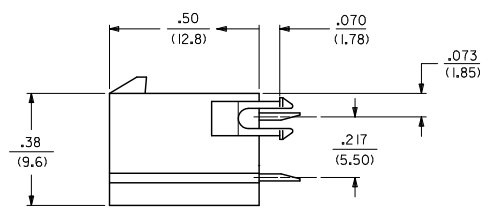
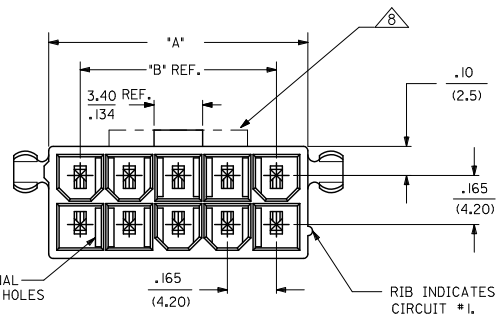

RECOMMENDED HOLE LAYOUT FOR .070/(1.78) MAX. THICK P. C. BOARD
VIEWED FROM COMPONENT SIDE

SEE SHT. 1 FOR SINGLE ROW

SEE SHEET 1 EC NO. UCP2011-0640 DRAWN: JAGUILAR 2010/12/16 CHKD: JBEL 2010/12/16 APPR: SMITH 2010/12/19	QUALITY SYMBOLS $\nabla \Rightarrow \circ$ $\nabla \Rightarrow \square$ $\nabla \Rightarrow \square$	GENERAL TOLERANCES (UNLESS SPECIFIED)		DIMENSION STYLE		SCALE	DESIGN UNITS	THIRD ANGLE PROJECTION	
		mm	INCH	IN/MM		4:1	METRIC		
L2 REV	DESCRIPTION	4 PLACES	±.005	±.005	DRAWN BY	DATE	TITLE		
		3 PLACES	±.015	±.015	GEP	1994/07/25	MINI-FIT VERT HDR ASSY		
		2 PLACES	±.020	±.020	CHECKED BY	DATE	W & W/O PEGS/DRAIN HOLES		
		1 PLACE	±.050	±.050	RJF	1994/07/25	SINGLE AND DUAL ROW		
		ANGULAR ±1/2°			APPROVED BY	DATE	MOLEX INCORPORATED		
		DRAFT WHERE APPLICABLE MUST REMAIN WITHIN DIMENSIONS		SEE CHARTS		DOCUMENT NO.		SHEET NO.	
				C		SDA-44472-****		2 OF 8	
THIS DRAWING CONTAINS INFORMATION THAT IS PROPRIETARY TO MOLEX INCORPORATED AND SHOULD NOT BE USED WITHOUT WRITTEN PERMISSION									

12 11 10 9 8 7 6 5 4 3 2 1

13 12 11 10 9 8 7 6 5 4 3 2 1

DUAL ROW PART NUMBERS WITH BRIGHT TIN PLATING

WITH PEGS

PLATING: I (SEE NOTE 2)		PLATING: I (SEE NOTE 2)		PLATING: I (SEE NOTE 2)		PLATING: I (SEE NOTE 2)	
DRAINS: WITHOUT DRAIN HOLES		DRAINS: WITHOUT DRAIN HOLES		DRAINS: WITH DRAIN HOLES		DRAINS: WITH DRAIN HOLES	
PEGS: WITH PEGS		PEGS: WITH PEGS		PEGS: WITH PEGS		PEGS: WITH PEGS	
MAT'L: 94V-2 [NATURAL]		MAT'L: 94V-0 [NATURAL]		MAT'L: 94V-2 [NATURAL]		MAT'L: 94V-0 [NATURAL]	
PACKAGING: PK-5566-001		PACKAGING: PK-5566-001		PACKAGING: PK-5566-001		PACKAGING: PK-5566-001	
ITEM NO.	CKTS	ITEM NO.	CKTS	ITEM NO.	CKTS	ITEM NO.	CKTS
44472-0250	2	44472-0251	2	44472-0252	2	44472-0253	2
44472-0450	4	44472-0451	4	44472-0452	4	44472-0453	4
44472-0650	6	44472-0651	6	44472-0652	6	44472-0653	6
44472-0850	8	44472-0851	8	44472-0852	8	44472-0853	8
44472-1050	10	44472-1051	10	44472-1052	10	44472-1053	10
44472-1250	12	44472-1251	12	44472-1252	12	44472-1253	12
44472-1450	14	44472-1451	14	44472-1452	14	44472-1453	14
44472-1650	16	44472-1651	16	44472-1652	16	44472-1653	16
44472-1850	18	44472-1851	18	44472-1852	18	44472-1853	18
44472-2050	20	44472-2051	20	44472-2052	20	44472-2053	20
44472-2250	22	44472-2251	22	44472-2252	22	44472-2253	22
44472-2450	24	44472-2451	24	44472-2452	24	44472-2453	24

WITHOUT PEGS

PLATING: I (SEE NOTE 2)		PLATING: I (SEE NOTE 2)		PLATING: I (SEE NOTE 2)		PLATING: I (SEE NOTE 2)		
DRAINS: WITHOUT DRAIN HOLES		DRAINS: WITHOUT DRAIN HOLES		DRAINS: WITH DRAIN HOLES		DRAINS: WITH DRAIN HOLES		
PEGS: WITHOUT PEGS		PEGS: WITHOUT PEGS		PEGS: WITHOUT PEGS		PEGS: WITHOUT PEGS		
MAT'L: 94V-2 [NATURAL]		MAT'L: 94V-0 [NATURAL]		MAT'L: 94V-2 [NATURAL]		MAT'L: 94V-0 [NATURAL]		
PACKAGING: PK-5566-001		PACKAGING: PK-5566-001		PACKAGING: PK-5566-001		PACKAGING: PK-5566-001		
ITEM NO.	HOUSING NO.	CKTS	ITEM NO.	CKTS	ITEM NO.	CKTS	ITEM NO.	
44472-0254		2	44472-0255	2	44472-0256	2	44472-0257	
44472-0454		4	44472-0455	4	44472-0456	4	44472-0457	
44472-0654		6	44472-0655	6	44472-0656	6	44472-0657	
44472-0854		8	44472-0855	8	44472-0856	8	44472-0857	
44472-1054		10	44472-1055	10	44472-1056	10	44472-1057	
44472-1254		12	44472-1255	12	44472-1256	12	44472-1257	
44472-1454		14	44472-1455	14	44472-1456	14	44472-1457	
44472-1654		16	44472-1655	16	44472-1656	16	44472-1657	
44472-1854		18	44472-1855	18	44472-1856	18	44472-1857	
44472-2054		20	44472-2055	20	44472-2056	20	44472-2057	
44472-2254		22	44472-2255	22	44472-2256	22	44472-2257	
44472-2454		24	44472-2455	24	44472-2456	24	44472-2457	

* ITEMS PRECEDED BY AN 'X' ARE NOT AVAILABLE.

SEE SHEET 1 EC NO: UCP201-0640 DRAWN: JAGUILAR 20/07/16 CHKD: JBEL 20/07/16 APPR: ESMITH 20/07/19	QUALITY SYMBOLS □=0 ▽=0 ▽=0	GENERAL TOLERANCES (UNLESS SPECIFIED)		DIMENSION STYLE IN/MM		SCALE 1:1	DESIGN UNITS METRIC	THIRD ANGLE PROJECTION	
		4 PLACES ±.015	3 PLACES ±.015	2 PLACES ±.038	1 PLACE ±0.50	mm	INCH	DRAWN BY: GEP DATE: 1994/07/25 CHECKED BY: RJJ DATE: 1994/07/25	
		ANGULAR ±1/2°		APPROVED BY: RJJ DATE: 1994/07/25		TITLE MINI-FIT VERT HDR ASSY W & W/O PEGS/DRAIN HOLES SINGLE AND DUAL ROW			
		DRAFT WHERE APPLICABLE MUST REMAIN WITHIN DIMENSIONS		SEE CHARTS		MATERIAL NO.		DOCUMENT NO.	

THIS DRAWING CONTAINS INFORMATION THAT IS PROPRIETARY TO MOLEX INCORPORATED AND SHOULD NOT BE USED WITHOUT WRITTEN PERMISSION

12 11 10 9 8 7 6 5 4 3 2 1

lb_frame_C.P.A.M.T
Rev. F 2009/06/18

13 12 11 10 9 8 7 6 5 4 3 2 1

DUAL ROW PART NUMBERS WITH SELECT GOLD PLATING

WITH PEGS

PLATING: 2 (SEE NOTE 2)		PLATING: 2 (SEE NOTE 2)		PLATING: 2 (SEE NOTE 2)		PLATING: 2 (SEE NOTE 2)	
DRAINS: WITHOUT DRAIN HOLES		DRAINS: WITHOUT DRAIN HOLES		DRAINS: WITH DRAIN HOLES		DRAINS: WITH DRAIN HOLES	
PEGS: WITH PEGS		PEGS: WITH PEGS		PEGS: WITH PEGS		PEGS: WITH PEGS	
MAT'L: 94V-2 [NATURAL]		MAT'L: 94V-0 [NATURAL]		MAT'L: 94V-2 [NATURAL]		MAT'L: 94V-0 [NATURAL]	
PACKAGING: PK-5566-001		PACKAGING: PK-5566-001		PACKAGING: PK-5566-001		PACKAGING: PK-5566-001	
ITEM NO.	CKTS	ITEM NO.	CKTS	ITEM NO.	CKTS	ITEM NO.	CKTS
X 44472-0260	2	X 44472-0261	2	44472-0262	2	X 44472-0263	2
X 44472-0460	4	X 44472-0461	4	X 44472-0462	4	X 44472-0463	4
X 44472-0660	6	X 44472-0661	6	X 44472-0662	6	X 44472-0663	6
X 44472-0860	8	X 44472-0861	8	X 44472-0862	8	X 44472-0863	8
X 44472-1060	10	X 44472-1061	10	X 44472-1062	10	X 44472-1063	10
X 44472-1260	12	X 44472-1261	12	X 44472-1262	12	X 44472-1263	12
X 44472-1460	14	X 44472-1461	14	X 44472-1462	14	X 44472-1463	14
X 44472-1660	16	X 44472-1661	16	X 44472-1662	16	X 44472-1663	16
X 44472-1860	18	X 44472-1861	18	X 44472-1862	18	X 44472-1863	18
X 44472-2060	20	X 44472-2061	20	X 44472-2062	20	X 44472-2063	20
X 44472-2260	22	X 44472-2261	22	X 44472-2262	22	X 44472-2263	22
X 44472-2460	24	X 44472-2461	24	X 44472-2462	24	X 44472-2463	24

WITHOUT PEGS

PLATING: 2 (SEE NOTE 2)		PLATING: 2 (SEE NOTE 2)		PLATING: 2 (SEE NOTE 2)		PLATING: 2 (SEE NOTE 2)	
DRAINS: WITHOUT DRAIN HOLES		DRAINS: WITHOUT DRAIN HOLES		DRAINS: WITH DRAIN HOLES		DRAINS: WITH DRAIN HOLES	
PEGS: WITHOUT PEGS		PEGS: WITHOUT PEGS		PEGS: WITHOUT PEGS		PEGS: WITHOUT PEGS	
MAT'L: 94V-2 [NATURAL]		MAT'L: 94V-0 [NATURAL]		MAT'L: 94V-2 [NATURAL]		MAT'L: 94V-0 [NATURAL]	
PACKAGING: PK-5566-001		PACKAGING: PK-5566-001		PACKAGING: PK-5566-001		PACKAGING: PK-5566-001	
ITEM NO.	CKTS	ITEM NO.	CKTS	ITEM NO.	CKTS	ITEM NO.	CKTS
X 44472-0264	2	X 44472-0265	2	44472-0267	2	X 44472-0268	2
X 44472-0464	4	X 44472-0465	4	X 44472-0467	4	X 44472-0468	4
X 44472-0664	6	X 44472-0665	6	X 44472-0667	6	X 44472-0668	6
X 44472-0864	8	X 44472-0865	8	X 44472-0867	8	X 44472-0868	8
X 44472-1064	10	X 44472-1065	10	X 44472-1067	10	X 44472-1068	10
X 44472-1264	12	X 44472-1265	12	X 44472-1267	12	X 44472-1268	12
X 44472-1464	14	X 44472-1465	14	X 44472-1467	14	X 44472-1468	14
X 44472-1664	16	X 44472-1665	16	X 44472-1667	16	X 44472-1668	16
X 44472-1864	18	X 44472-1865	18	X 44472-1867	18	X 44472-1868	18
X 44472-2064	20	X 44472-2065	20	X 44472-2067	20	X 44472-2068	20
X 44472-2264	22	X 44472-2265	22	X 44472-2267	22	X 44472-2268	22
X 44472-2464	24	X 44472-2465	24	X 44472-2467	24	X 44472-2468	24

* ITEMS PRECEDED BY A "X" ARE NOT AVAILABLE.

SEE SHEET 1 EC NO: UCP2011-0640 DRAWN: JAGUILAR 20/07/16 CHKD: JBEL 20/07/16 APPR: SMITH 20/07/19 REV	QUALITY SYMBOLS	GENERAL TOLERANCES (UNLESS SPECIFIED)	DIMENSION STYLE	SCALE	DESIGN UNITS	THIRD ANGLE PROJECTION	
	□ = 0 ▽ = 0 ▽ = 0	mm INCH 4 PLACES ±.005 ±.005 3 PLACES ±.015 ±.015 2 PLACES ±0.38 ±.020 1 PLACE ±0.50 ±.020 ANGULAR ±1/2°	IN/MM DRAWN BY DATE GEP 1994/07/25 CHECKED BY DATE RJF 1994/07/25 APPROVED BY DATE RJF 1994/07/25	METRIC	1:1	METRIC	MINI-FIT VERT HDR ASSY W & W/O PEGS/DRAIN HOLES SINGLE AND DUAL ROW
		DRAFT WHERE APPLICABLE MUST REMAIN WITHIN DIMENSIONS	SEE CHARTS	MATERIAL NO.	DOCUMENT NO.	SHEET NO.	MOLEX INCORPORATED SDA-44472-**** 4 OF 8
							THIS DRAWING CONTAINS INFORMATION THAT IS PROPRIETARY TO MOLEX INCORPORATED AND SHOULD NOT BE USED WITHOUT WRITTEN PERMISSION

12 11 10 9 8 7 6 5 4 3 2 1

13 12 11 10 9 8 7 6 5 4 3 2 1

DUAL ROW PART NUMBERS WITH WIDE LATCH OPTION

WITH PEGS

PLATING:	1 (SEE NOTE 2)	
DRAINS:	WITH DRAIN HOLES	
PEGS:	WITH PEGS	
MAT'L:	94V-2 [NATURAL]	
PACKAGING:	PK-5566-001	
	ITEM NO.	CKTS
X	44472-0270	2
X	44472-0470	4
X	44472-0670	6
X	44472-0870	8
X	44472-1070	10
X	44472-1270	12
X	44472-1470	14
X	44472-1670	16
X	44472-1870	18
X	44472-2070	20
X	44472-2270	22
X	44472-2470	24

* ITEMS PRECEDED BY "X" ARE NOT AVAILABLE.

SEE SHEET 1 EC NO: UCP2011-0640 DRWN: JAGUILAR 20/07/16 CHKD: JBEL 20/07/16 APPR: ESMITH 20/07/19	QUALITY SYMBOLS	GENERAL TOLERANCES (UNLESS SPECIFIED)	DIMENSION STYLE	SCALE	DESIGN UNITS	THIRD ANGLE PROJECTION
	▽=0	mm INCH	IN/MM	1:1	METRIC	
	▽=0	4 PLACES ±.000 ±.000	DRAWN BY DATE	GEP 1994/07/25	TITLE	MINI-FIT VERT HDR ASSY
	▽=0	3 PLACES ±.015	CHECKED BY DATE	RJF 1994/07/25	W & W/O PEGS/DRAIN HOLES	SINGLE AND DUAL ROW
▽=0	2 PLACES ±0.38 ±.020	APPROVED BY DATE	RJF 1994/07/25	MATERIAL NO.	MOLEX INCORPORATED	
	1 PLACE ±0.50 ±.000	ANGULAR ±1/2°		DOCUMENT NO.	SDA-44472-****	
		DRAFT WHERE APPLICABLE MUST REMAIN WITHIN DIMENSIONS	SIZE C	THIS DRAWING CONTAINS INFORMATION THAT IS PROPRIETARY TO MOLEX INCORPORATED AND SHOULD NOT BE USED WITHOUT WRITTEN PERMISSION		SHEET NO. 5 OF 8

12 11 10 9 8 7 6 5 4 3 2 1

1b_frame_C.P. AM.T Rev. F 2009/06/18

13 12 11 10 9 8 7 6 5 4 3 2 1

SINGLE ROW PART NUMBERS WITH PEGS

BRIGHT TIN PLATING

PLATING: 1 (SEE NOTE 2)		PLATING: 1 (SEE NOTE 2)		PLATING: 1 (SEE NOTE 2)		PLATING: 1 (SEE NOTE 2)	
DRAINS: WITH DRAIN HOLES		DRAINS: WITH DRAIN HOLES		DRAINS: WITHOUT DRAIN HOLES		DRAINS: WITHOUT DRAIN HOLES	
PEGS: WITH PEGS		PEGS: WITH PEGS		PEGS: WITH PEGS		PEGS: WITH PEGS	
MAT'L: 94V-2 [NATURAL]		MAT'L: 94V-0 [NATURAL]		MAT'L: 94V-2 [NATURAL]		MAT'L: 94V-0 [NATURAL]	
PACKAGING: PK-5566-002		PACKAGING: PK-5566-002		PACKAGING: PK-5566-002		PACKAGING: PK-5566-002	
ITEM NO.	CKTS	ITEM NO.	CKTS	ITEM NO.	CKTS	ITEM NO.	CKTS
X 44472-0401	4 X	44472-0402	4	44472-0403	4 X	44472-0404	4
X 44472-0501	5	44472-0502	5 X	44472-0503	5	44472-0504	5
X 44472-0601	6 X	44472-0602	6	44472-0603	6 X	44472-0604	6
X 44472-0701	7 X	44472-0702	7	44472-0703	7 X	44472-0704	7
X 44472-0801	8 X	44472-0802	8	44472-0803	8 X	44472-0804	8
X 44472-0901	9 X	44472-0902	9	44472-0903	9 X	44472-0904	9
X 44472-1001	10 X	44472-1002	10	44472-1003	10 X	44472-1004	10
X 44472-1101	11 X	44472-1102	11	44472-1103	11 X	44472-1104	11
X 44472-1201	12 X	44472-1202	12	44472-1203	12 X	44472-1204	12

GOLD PLATING

PLATING: 2 (SEE NOTE 2)		PLATING: 2 (SEE NOTE 2)		PLATING: 2 (SEE NOTE 2)		PLATING: 2 (SEE NOTE 2)	
DRAINS: WITHOUT DRAIN HOLES		DRAINS: WITHOUT DRAIN HOLES		DRAINS: WITHOUT DRAIN HOLES		DRAINS: WITHOUT DRAIN HOLES	
PEGS: WITH PEGS		PEGS: WITH PEGS		PEGS: WITH PEGS		PEGS: WITH PEGS	
MAT'L: 94V-2 [NATURAL]		MAT'L: 94V-0 [NATURAL]		MAT'L: 94V-2 [NATURAL]		MAT'L: 94V-0 [NATURAL]	
PACKAGING: PK-5566-002		PACKAGING: PK-5566-002		PACKAGING: PK-5566-002		PACKAGING: PK-5566-002	
ITEM NO.	CKTS	ITEM NO.	CKTS	ITEM NO.	CKTS	ITEM NO.	CKTS
	4		4 X	44472-0407	4	44472-0408	4
	5		5 X	44472-0507	5	44472-0508	5
	6		6 X	44472-0607	6	44472-0608	6
	7		7 X	44472-0707	7	44472-0708	7
	8		8 X	44472-0807	8	44472-0808	8
	9		9 X	44472-0907	9	44472-0908	9
	10		10 X	44472-1007	10	44472-1008	10
	11		11 X	44472-1107	11	44472-1108	11
	12		12 X	44472-1207	12	44472-1208	12

SEE SHEET 1 EC NO: UCF2011-0640 DRWN: JAGUILAR 2010/12/16 CHKD: JBEL 2010/12/16 APPR: ESMITH 2010/12/19	QUALITY SYMBOLS ▽=0 ▽=0 ▽=0	GENERAL TOLERANCES (UNLESS SPECIFIED) mm INCH 4 PLACES ±.000 ±.000 3 PLACES ±.005 ±.015 2 PLACES ±.030 ±.020 1 PLACE ±.050 ±.000 ANGULAR ±1/2°		DIMENSION STYLE IN/MM	SCALE 1:1	DESIGN UNITS METRIC	THIRD ANGLE PROJECTION
		DRAWN BY: GEP DATE: 1994/07/25 CHECKED BY: RJF DATE: 1994/07/25 APPROVED BY: RJF DATE: 1994/07/25		TITLE MINI-FIT VERT HDR ASSY W & W/O PEGS/DRAIN HOLES SINGLE AND DUAL ROW		MOLEX INCORPORATED	
		MATERIAL NO. SDA-44472-**** DOCUMENT NO.		SHEET NO. 6 OF 8		THIS DRAWING CONTAINS INFORMATION THAT IS PROPRIETARY TO MOLEX INCORPORATED AND SHOULD NOT BE USED WITHOUT WRITTEN PERMISSION	
		DRAFT WHERE APPLICABLE MUST REMAIN WITHIN DIMENSIONS		SEE CHART		SIZE C	

12 11 10 9 8 7 6 5 4 3 2 1

13 12 11 10 9 8 7 6 5 4 3 2 1

DUAL ROW PART NUMBERS 1 PEG REMOVED

PLATING:	1 (SEE NOTE 2)	PLATING:	1 (SEE NOTE 2)	PLATING:		PLATING:	
DRAINS:	WITHOUT DRAIN HOLES	DRAINS:	WITH DRAIN HOLES	DRAINS:		DRAINS:	
PEGS:	PEG #1 REMOVED	PEGS:	PEG #1 REMOVED	PEGS:	PEG #1 REMOVED	PEGS:	PEG #1 REMOVED
MAT'L:	92V-2 (NATURAL)	MAT'L:	92V-2 (NATURAL)	MAT'L:		MAT'L:	
PACKAGING:	PK-5566-001	PACKAGING:	PK-5566-001	PACKAGING:		PACKAGING:	
X	ITEM NO.	CKTS	X	ITEM NO.	CKTS	ITEM NO.	CKTS
X	44472-0273	2	X	44472-0274	2		2
X	44472-0473	4	X	44472-0474	4		4
X	44472-0673	6	X	44472-0674	6		6
X	44472-0873	8	X	44472-0874	8		8
X	44472-1073	10	X	44472-1074	10		10
X	44472-1273	12	X	44472-1274	12		12
X	44472-1473	14	X	44472-1474	14		14
X	44472-1673	16	X	44472-1674	16		16
X	44472-1873	18	X	44472-1874	18		18
	44472-2073	20		44472-2074	20		20
X	44472-2273	22	X	44472-2274	22		22
X	44472-2473	24	X	44472-2474	24		24

PLATING:	1 (SEE NOTE 2)	PLATING:	1 (SEE NOTE 2)	PLATING:		PLATING:	
DRAINS:	WITHOUT DRAIN HOLES	DRAINS:	WITH DRAIN HOLES	DRAINS:		DRAINS:	
PEGS:	PEG #2 REMOVED	PEGS:	PEG #2 REMOVED	PEGS:	PEG #2 REMOVED	PEGS:	PEG #2 REMOVED
MAT'L:	92V-2 (NATURAL)	MAT'L:	92V-2 (NATURAL)	MAT'L:		MAT'L:	
PACKAGING:	PK-5566-001	PACKAGING:	PK-5566-001	PACKAGING:		PACKAGING:	
X	ITEM NO.	CKTS	X	ITEM NO.	CKTS	ITEM NO.	CKTS
X	44472-0277	2	X	44472-0278	2		2
X	44472-0477	4	X	44472-0478	4		4
X	44472-0677	6	X	44472-0678	6		6
X	44472-0877	8	X	44472-0878	8		8
X	44472-1077	10	X	44472-1078	10		10
X	44472-1277	12	X	44472-1278	12		12
X	44472-1477	14	X	44472-1478	14		14
X	44472-1677	16	X	44472-1678	16		16
X	44472-1877	18	X	44472-1878	18		18
	44472-2077	20		44472-2078	20		20
X	44472-2277	22	X	44472-2278	22		22
X	44472-2477	24	X	44472-2478	24		24

* ITEMS PRECEDED BY AN 'X' ARE NOT AVAILABLE

SEE SHEET 1 EC NO: UCP2011-0640 DRWN: JAGUILAR 20/07/16 CHKD: JBEL 20/07/16 APPR: SMITH 20/07/19 REV	QUALITY SYMBOLS ▽=0 ▽=0 ▽=0	GENERAL TOLERANCES (UNLESS SPECIFIED): mm INCH 4 PLACES ±.000 ±.000 3 PLACES ±.005 ±.015 2 PLACES ±0.38 ±.020 1 PLACE ±0.50 ±.000 ANGULAR ±1/2°		DIMENSION STYLE IN/MM DRAWN BY: GEP DATE: 1994/07/25 CHECKED BY: RJF DATE: 1994/07/25 APPROVED BY: RJF DATE: 1994/07/25	SCALE: 1:1 DESIGN UNITS: METRIC THIRD ANGLE PROJECTION	TITLE: MINI-FIT VERT HDR ASSY W & W/O PEGS/DRAIN HOLES SINGLE AND DUAL ROW MOLEX INCORPORATED
		DRAFT WHERE APPLICABLE MUST REMAIN WITHIN DIMENSIONS		MATERIAL NO.: SEE CHART DOCUMENT NO.: SDA-44472-**** SHEET NO.: 7 OF 8	THIS DRAWING CONTAINS INFORMATION THAT IS PROPRIETARY TO MOLEX INCORPORATED AND SHOULD NOT BE USED WITHOUT WRITTEN PERMISSION	

12 11 10 9 8 7 6 5 4 3 2 1

13 12 11 10 9 8 7 6 5 4 3 2 1

DUAL ROW PART NUMBERS WITH MATTE TIN PLATING

WITH PEGS

PLATING:	3 (SEE NOTE 2)	PLATING:	3 (SEE NOTE 2)	PLATING:	3 (SEE NOTE 2)	PLATING:	3 (SEE NOTE 2)
DRAINS:	WITHOUT DRAIN HOLES	DRAINS:	WITHOUT DRAIN HOLES	DRAINS:	WITH DRAIN HOLES	DRAINS:	WITH DRAIN HOLES
PEGS:	WITH PEGS	PEGS:	WITH PEGS	PEGS:	WITH PEGS	PEGS:	WITH PEGS
MAT'L:	94V-2 [NATURAL]	MAT'L:	94V-0 [NATURAL]	MAT'L:	94V-2 [NATURAL]	MAT'L:	94V-0 [NATURAL]
PACKAGING:	PK-5566-001	PACKAGING:	PK-5566-001	PACKAGING:	PK-5566-001	PACKAGING:	PK-5566-001
ITEM NO.	CKTS	ITEM NO.	CKTS	ITEM NO.	CKTS	ITEM NO.	CKTS
X 44472-0280	2 X	44472-0281	2	44472-0282	2	44472-0283	2
X 44472-0480	4 X	44472-0481	4	44472-0482	4	44472-0483	4
X 44472-0680	6 X	44472-0681	6	44472-0682	6	44472-0683	6
X 44472-0880	8 X	44472-0881	8	44472-0882	8	44472-0883	8
X 44472-1080	10 X	44472-1081	10	44472-1082	10	44472-1083	10
X 44472-1280	12 X	44472-1281	12	44472-1282	12	44472-1283	12
X 44472-1480	14 X	44472-1481	14	44472-1482	14	44472-1483	14
X 44472-1680	16 X	44472-1681	16	44472-1682	16	44472-1683	16
X 44472-1880	18 X	44472-1881	18	44472-1882	18	44472-1883	18
X 44472-2080	20 X	44472-2081	20	44472-2082	20	44472-2083	20
X 44472-2280	22 X	44472-2281	22	44472-2282	22	44472-2283	22
X 44472-2480	24 X	44472-2481	24	44472-2482	24	44472-2483	24

WITHOUT PEGS

PLATING:	3 (SEE NOTE 2)	PLATING:	3 (SEE NOTE 2)
DRAINS:	WITHOUT DRAIN HOLES	DRAINS:	WITHOUT DRAIN HOLES
PEGS:	WITHOUT PEGS	PEGS:	WITHOUT PEGS
MAT'L:	94V-2 [NATURAL]	MAT'L:	94V-0 [NATURAL]
PACKAGING:	PK-5566-001	PACKAGING:	PK-5566-001
ITEM NO.	CKTS	ITEM NO.	CKTS
X 44472-0284	2 X	44472-0285	2
X 44472-0484	4 X	44472-0485	4
X 44472-0684	6 X	44472-0685	6
X 44472-0884	8 X	44472-0885	8
X 44472-1084	10 X	44472-1085	10
X 44472-1284	12 X	44472-1285	12
X 44472-1484	14 X	44472-1485	14
X 44472-1684	16 X	44472-1685	16
X 44472-1884	18 X	44472-1885	18
X 44472-2084	20 X	44472-2085	20
X 44472-2284	22 X	44472-2285	22
X 44472-2484	24 X	44472-2485	24

SEE SHEET 1 EC NO: UCP201-0640 DRWN: JAGUILAR 2010/12/16 CHKD: JBEL 2010/12/16 APPR: ESMITH 2010/12/19	QUALITY SYMBOLS ∇=0 ∇=0 ∇=0	GENERAL TOLERANCES (UNLESS SPECIFIED)	DIMENSION STYLE	SCALE	DESIGN UNITS	THIRD ANGLE PROJECTION	
		mm	IN/MM	1:1	METRIC		
		4 PLACES ±.005 ±.015	DRAWN BY	DATE	TITLE		
		3 PLACES ±.015 ±.020	GEP	1994/07/25	MINI-FIT VERT HDR ASSY W & W/O PEGS/DRAIN HOLES SINGLE AND DUAL ROW		
2 PLACES ±0.38 ±.020	CHECKED BY	DATE	MATERIAL NO.				
1 PLACE ±0.50 ±.020	RJF	1994/07/25	SDA-44472-****				
ANGULAR ±1/2°	APPROVED BY	DATE	DOCUMENT NO.				
	RJF	1994/07/25	MOLEX INCORPORATED				
DRAFT WHERE APPLICABLE MUST REMAIN WITHIN DIMENSIONS	SIZE	SEE CHART	SHEET NO.				
	C		8 OF 8				
			THIS DRAWING CONTAINS INFORMATION THAT IS PROPRIETARY TO MOLEX INCORPORATED AND SHOULD NOT BE USED WITHOUT WRITTEN PERMISSION				

12 11 10 9 8 7 6 5 4 3 2 1

1b_frame_C.P.A.M.T
Rev. F 2009/06/18

A

B

D

E

F

G

H

I

J