

13 12 11 10 9 8 7 6 5 4 3 2 1

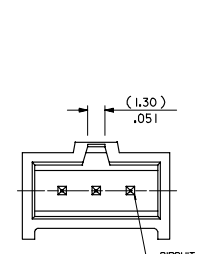

1 TO 3 CIRCUITS

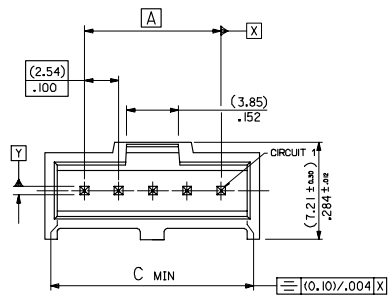

4 TO 32 CIRCUITS

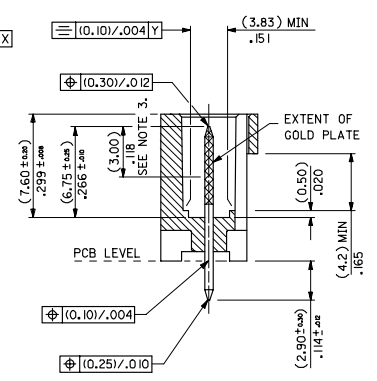
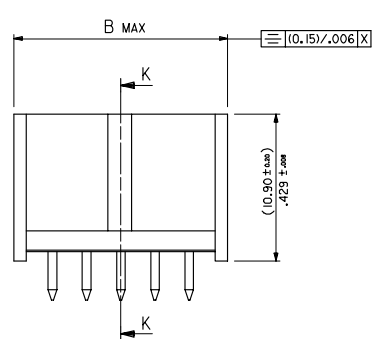
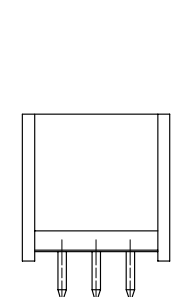

SECTION K-K

No. OF CKTS	DIM A	DIM B	DIM C
1		(5.89) / .232	(4.06) / .160
2	(2.54) / .100	(8.43) / .332	(6.60) / .260
3	(5.08) / .200	(10.97) / .432	(9.14) / .360
4	(7.62) / .300	(13.51) / .532	(11.68) / .460
5	(10.16) / .400	(16.05) / .632	(14.22) / .560
6	(12.70) / .500	(18.59) / .732	(16.76) / .660
7	(15.24) / .600	(21.13) / .832	(19.30) / .760
8	(17.78) / .700	(23.67) / .932	(21.84) / .860
9	(20.32) / .800	(26.21) / 1.032	(24.38) / .960
10	(22.86) / .900	(28.75) / 1.132	(26.92) / 1.060
11	(25.4) / 1.000	(31.29) / 1.232	(29.46) / 1.160
12	(27.94) / 1.100	(33.83) / 1.332	(32.00) / 1.260
13	(30.48) / 1.200	(36.37) / 1.432	(34.54) / 1.360
14	(33.02) / 1.300	(38.91) / 1.532	(37.08) / 1.460
15	(35.56) / 1.400	(41.45) / 1.632	(39.62) / 1.560
16	(38.10) / 1.500	(43.99) / 1.732	(42.16) / 1.660
17	(40.64) / 1.600	(46.53) / 1.832	(44.70) / 1.760
18	(43.18) / 1.700	(49.07) / 1.932	(47.24) / 1.860
19	(45.72) / 1.800	(51.61) / 2.032	(49.78) / 1.960
20	(48.26) / 1.900	(54.15) / 2.132	(52.32) / 2.060
21	(50.80) / 2.000	(56.69) / 2.232	(54.86) / 2.160
22	(53.34) / 2.100	(59.23) / 2.332	(57.40) / 2.260
23	(55.88) / 2.200	(61.77) / 2.432	(59.94) / 2.360
24	(58.42) / 2.300	(64.31) / 2.532	(62.48) / 2.460
25	(60.96) / 2.400	(66.85) / 2.632	(65.02) / 2.560
26	(63.50) / 2.500	(69.39) / 2.732	(67.56) / 2.660
27	(66.04) / 2.600	(71.93) / 2.832	(70.10) / 2.760
28	(68.58) / 2.700	(74.47) / 2.932	(72.64) / 2.860
29	(71.12) / 2.800	(77.01) / 3.032	(75.18) / 2.960
30	(73.66) / 2.900	(79.55) / 3.132	(77.72) / 3.060
31	(76.20) / 3.000	(82.09) / 3.232	(80.26) / 3.160
32	(78.74) / 3.100	(84.63) / 3.332	(82.80) / 3.260

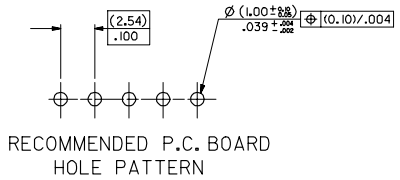

RECOMMENDED P.C. BOARD HOLE PATTERN

- NOTES
- MATERIAL:-
 - PIN:- (0.635)/.025 SO.BRASS WIRE.
 - HOUSING:- 15% GLASS FILLED POLYESTER
 - UL 94 V-0 COLOUR BLACK
 - FOR PLATING VERSIONS SEE SHEET 2.
 - MEASUREMENT POINT FOR MINIMUM PLATING THICKNESS
 - PRODUCT SPEC: PS-99020-0001
 - RECOMMENDED PCB THICKNESS 1.6mm

ADDED CIRCUIT 1 INDICATOR EC NO: E2008-0112 DRAWN BY: RAMESH CHKD: JAYALAKSHMI APPR: JAYALAKSHMI DATE: 2007/09/10 DATE: 2007/09/11	QUALITY SYMBOLS ▽=0 ▽=0	GENERAL TOLERANCES (UNLESS SPECIFIED) 4 PLACES ±.004 ±.004 3 PLACES ±.004 ±.004 2 PLACES ±.010 ±.010 1 PLACE ±.010 ±.010 ANGULAR ±1/2°	DIMENSION STYLE MM/IN	SCALE 5:1	DESIGN UNITS METRIC	THIRD ANGLE PROJECTION
			DRAWN BY KS	DATE 1987/10/30	TITLE C-GRID III SINGLE ROW STRAIGHT SHROUDED HEADER	
DRAFT WHERE APPLICABLE MUST REMAIN WITHIN DIMENSIONS		MATERIAL NO. SEE CHART	DOCUMENT NO. SDA-90136		SHEET NO. 1 OF 100	

		PART NUMBERS		
	NO. OF CKTS	PLATING TYPE A	PLATING TYPE E	PLATING TYPE F
	1	90136-1101	90136-1201	90136-1301
	2	▲ -1102	▲ -1202	▲ -1302
	3	-1103	-1203	-1303
	4	-1104	-1204	-1304
	5	-1105	-1205	-1305
	6	-1106	-1206	-1306
	7	-1107	-1207	-1307
	8	-1108	-1208	-1308
	9	-1109	-1209	-1309
	10	-1110	-1210	-1310
	11	-1111	-1211	-1311
	12	-1112	-1212	-1312
	13	-1113	-1213	-1313
	14	-1114	-1214	-1314
	15	-1115	-1215	-1315
	16	-1116	-1216	-1316
	17	-1117	-1217	-1317
	18	-1118	-1218	-1318
	19	-1119	-1219	-1319
	20	-1120	-1220	-1320
	21	-1121	-1221	-1321
	22	-1122	-1222	-1322
	23	-1123	-1223	-1323
	24	-1124	-1224	-1324
	25	-1125	-1225	-1325
	26	-1126	-1226	-1326
	27	-1127	-1227	-1327
	28	-1128	-1228	-1328
	29	-1129	-1229	-1329
	30	-1130	-1230	-1330
	31	▼ -1131	▼ -1231	▼ -1331
	32	90136-1132	90136-1232	90136-1332

NOTES
 1.FOR ASSY SEE SHEET 1
 2.FOR PLATING DETAILS SEE SDES 99000-0003

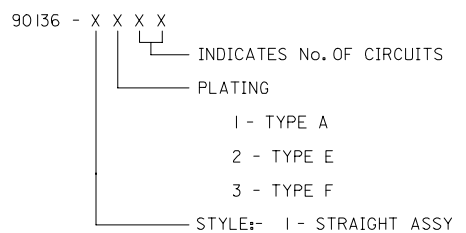

CORRECTED TABLE EC NO: E2007-1001 DRAWN BY: RINES CHKD: 2007/06/07 APPR: EDMAHONY 2007/06/07	QUALITY SYMBOLS	GENERAL TOLERANCES (UNLESS SPECIFIED)	DIMENSION STYLE MM ONLY	SCALE ---	DESIGN UNITS METRIC	THIRD ANGLE PROJECTION
	▽=0	4 PLACES ± --- ± ---	mm	DRAWN BY KS	DATE 1987/09/28	TITLE C-GRID 111 SINGLE ROW STRAIGHT SHROUDED HEADER
	▽=0	3 PLACES ± --- ± ---	INCH	CHECKED BY	DATE	MOLEX INCORPORATED
		2 PLACES ± --- ± ---		APPROVED BY	DATE	MATERIAL NO.
		1 PLACE ± --- ± ---				DOCUMENT NO. SDA-90136
		ANGULAR ± ---°				SHEET NO. 2 OF 8
		DRAFT WHERE APPLICABLE MUST REMAIN WITHIN DIMENSIONS	SEE CHART	THIS DRAWING CONTAINS INFORMATION THAT IS PROPRIETARY TO MOLEX INCORPORATED AND SHOULD NOT BE USED WITHOUT WRITTEN PERMISSION		