

13 12 11 10 9 8 7 6 5 4 3 2 1

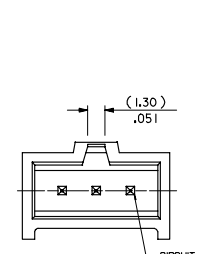

1 TO 3 CIRCUITS

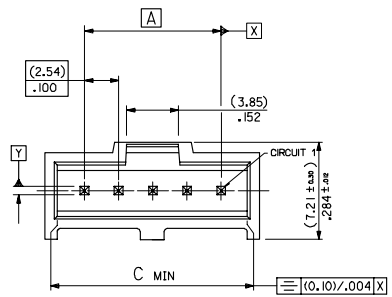

4 TO 32 CIRCUITS

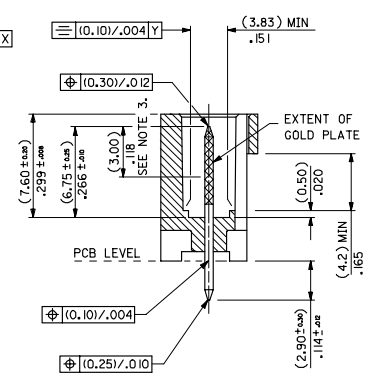
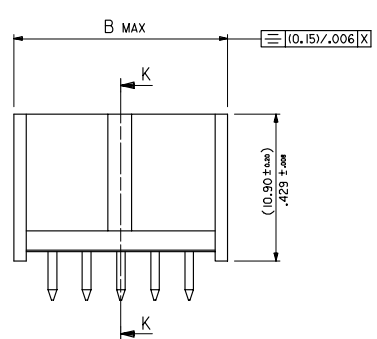
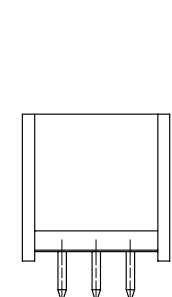

SECTION K-K

No. OF CKTS	DIM A	DIM B	DIM C
1		( 5.89 ) / .232	( 4.06 ) / .160
2	( 2.54 ) / .100	( 8.43 ) / .332	( 6.60 ) / .260
3	( 5.08 ) / .200	( 10.97 ) / .432	( 9.14 ) / .360
4	( 7.62 ) / .300	( 13.51 ) / .532	( 11.68 ) / .460
5	( 10.16 ) / .400	( 16.05 ) / .632	( 14.22 ) / .560
6	( 12.70 ) / .500	( 18.59 ) / .732	( 16.76 ) / .660
7	( 15.24 ) / .600	( 21.13 ) / .832	( 19.30 ) / .760
8	( 17.78 ) / .700	( 23.67 ) / .932	( 21.84 ) / .860
9	( 20.32 ) / .800	( 26.21 ) / 1.032	( 24.38 ) / .960
10	( 22.86 ) / .900	( 28.75 ) / 1.132	( 26.92 ) / 1.060
11	( 25.4 ) / 1.000	( 31.29 ) / 1.232	( 29.46 ) / 1.160
12	( 27.94 ) / 1.100	( 33.83 ) / 1.332	( 32.00 ) / 1.260
13	( 30.48 ) / 1.200	( 36.37 ) / 1.432	( 34.54 ) / 1.360
14	( 33.02 ) / 1.300	( 38.91 ) / 1.532	( 37.08 ) / 1.460
15	( 35.56 ) / 1.400	( 41.45 ) / 1.632	( 39.62 ) / 1.560
16	( 38.10 ) / 1.500	( 43.99 ) / 1.732	( 42.16 ) / 1.660
17	( 40.64 ) / 1.600	( 46.53 ) / 1.832	( 44.70 ) / 1.760
18	( 43.18 ) / 1.700	( 49.07 ) / 1.932	( 47.24 ) / 1.860
19	( 45.72 ) / 1.800	( 51.61 ) / 2.032	( 49.78 ) / 1.960
20	( 48.26 ) / 1.900	( 54.15 ) / 2.132	( 52.32 ) / 2.060
21	( 50.80 ) / 2.000	( 56.69 ) / 2.232	( 54.86 ) / 2.160
22	( 53.34 ) / 2.100	( 59.23 ) / 2.332	( 57.40 ) / 2.260
23	( 55.88 ) / 2.200	( 61.77 ) / 2.432	( 59.94 ) / 2.360
24	( 58.42 ) / 2.300	( 64.31 ) / 2.532	( 62.48 ) / 2.460
25	( 60.96 ) / 2.400	( 66.85 ) / 2.632	( 65.02 ) / 2.560
26	( 63.50 ) / 2.500	( 69.39 ) / 2.732	( 67.56 ) / 2.660
27	( 66.04 ) / 2.600	( 71.93 ) / 2.832	( 70.10 ) / 2.760
28	( 68.58 ) / 2.700	( 74.47 ) / 2.932	( 72.64 ) / 2.860
29	( 71.12 ) / 2.800	( 77.01 ) / 3.032	( 75.18 ) / 2.960
30	( 73.66 ) / 2.900	( 79.55 ) / 3.132	( 77.72 ) / 3.060
31	( 76.20 ) / 3.000	( 82.09 ) / 3.232	( 80.26 ) / 3.160
32	( 78.74 ) / 3.100	( 84.63 ) / 3.332	( 82.80 ) / 3.260

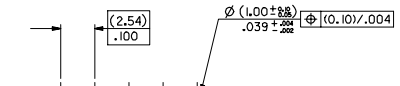

RECOMMENDED P.C. BOARD HOLE PATTERN

- NOTES
- MATERIAL:-
    - PIN:- (0.635)/.025 SO.BRASS WIRE.
    - HOUSING:- 15% GLASS FILLED POLYESTER
    - UL 94 V-0 COLOUR BLACK
  - FOR PLATING VERSIONS SEE SHEET 2.
  - MEASUREMENT POINT FOR MINIMUM PLATING THICKNESS
  - PRODUCT SPEC: PS-99020-0001
  - RECOMMENDED PCB THICKNESS 1.6mm

ADDED CIRCUIT 1 INDICATOR EC NO: E2008-0112 DRAWN BY: RAMESH CHKD: JAYALAKSHMI APPR: JAYALAKSHMI DATE: 2007/09/10 DATE: 2007/09/11	QUALITY SYMBOLS ▽=0 ▽=0	GENERAL TOLERANCES (UNLESS SPECIFIED) 4 PLACES ±.004 ±.004 3 PLACES ±.004 ±.004 2 PLACES ±.010 ±.010 1 PLACE ±.010 ±.010 ANGULAR ±1/2°	DIMENSION STYLE MM/IN	SCALE 5:1	DESIGN UNITS METRIC	THIRD ANGLE PROJECTION
			DRAWN BY KS	DATE 1987/10/30	TITLE C-GRID III SINGLE ROW STRAIGHT SHROUDED HEADER	
DRAFT WHERE APPLICABLE MUST REMAIN WITHIN DIMENSIONS		MATERIAL NO. SEE CHART	DOCUMENT NO. SDA-90136		SHEET NO. 1 OF 100	

		PART NUMBERS		
NO. OF CKTS	PLATING TYPE A	PLATING TYPE E	PLATING TYPE F	
1	90136-1101	90136-1201	90136-1301	
2	▲ -1102	▲ -1202	▲ -1302	
3	-1103	-1203	-1303	
4	-1104	-1204	-1304	
5	-1105	-1205	-1305	
6	-1106	-1206	-1306	
7	-1107	-1207	-1307	
8	-1108	-1208	-1308	
9	-1109	-1209	-1309	
10	-1110	-1210	-1310	
11	-1111	-1211	-1311	
12	-1112	-1212	-1312	
13	-1113	-1213	-1313	
14	-1114	-1214	-1314	
15	-1115	-1215	-1315	
16	-1116	-1216	-1316	
17	-1117	-1217	-1317	
18	-1118	-1218	-1318	
19	-1119	-1219	-1319	
20	-1120	-1220	-1320	
21	-1121	-1221	-1321	
22	-1122	-1222	-1322	
23	-1123	-1223	-1323	
24	-1124	-1224	-1324	
25	-1125	-1225	-1325	
26	-1126	-1226	-1326	
27	-1127	-1227	-1327	
28	-1128	-1228	-1328	
29	-1129	-1229	-1329	
30	-1130	-1230	-1330	
31	▼ -1131	▼ -1231	▼ -1331	
32	90136-1132	90136-1232	90136-1332	

NOTES  
 1.FOR ASSY SEE SHEET 1  
 2.FOR PLATING DETAILS SEE SDES 99000-0003

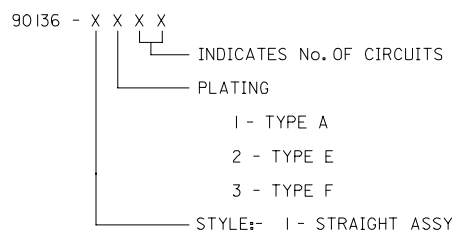

CORRECTED TABLE EC NO: E2007-1001 DRAWN BY: RINES CHKD: 2007/06/07 APPR: EDMAHONY 2007/06/07	QUALITY SYMBOLS ▽=0 ▽=0	GENERAL TOLERANCES (UNLESS SPECIFIED)	DIMENSION STYLE MM ONLY	SCALE ---	DESIGN UNITS METRIC	THIRD ANGLE PROJECTION
		mm    INCH	DRAWN BY KS	DATE 1987/09/28	TITLE C-GRID 111 SINGLE ROW STRAIGHT SHROUDED HEADER	
		4 PLACES ± --- ± --- 3 PLACES ± --- ± --- 2 PLACES ± --- ± --- 1 PLACE ± --- ± --- ANGULAR ± ---°	CHECKED BY DATE	APPROVED BY DATE	MOLEX INCORPORATED	
		DRAFT WHERE APPLICABLE MUST REMAIN WITHIN DIMENSIONS	MATERIAL NO. SEE CHART	DOCUMENT NO. SDA-90136	SHEET NO. 2 OF 8	