

6 5 4 3 2 1

CENTERLINE OF PIN IN AREA SHOWN NOT TO VARY FROM CENTERLINE OF PIN AT -D- BY MORE THAN 0.13/.005 IN ANY DIRECTION.

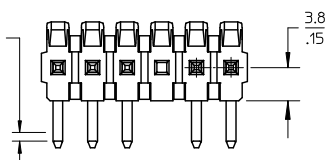

A-41672- * N * **
 OPTION - PACKING
 A= 2161 PIN- BULK PACK
 B= 43294 PIN- BULK PACK
 NO OF CKTS
 DIM M.L.P
 PLATING
 VOID LOCATIONS
 BLANK=NO VOIDS
 NO=CKT NO VOIDED
 MULT-VOIDS=51 UP

CIRCUIT	A	B
2	6.78/7.87 .267/.310	3.96 .156
3	10.74/11.84 .423/.466	7.92 .312
4	14.71/15.80 .579/.622	11.89 .468
5	18.67/19.76 .735/.778	15.85 .624
6	22.63/23.72 .891/.934	19.81 .780
7	26.59/27.69 1.047/1.090	23.77 .936
8	30.56/31.65 1.203/1.246	27.74 1.092
9	34.52/35.61 1.359/1.402	31.70 1.248
10	38.48/39.57 1.515/1.558	35.66 1.404
11	42.44/43.54 1.671/1.714	39.62 1.560
12	46.41/47.50 1.827/1.870	43.59 1.716
13	50.37/51.46 1.983/2.026	47.55 1.872
14	54.33/55.42 2.139/2.182	51.51 2.028
15	58.29/59.39 2.295/2.338	55.47 2.184
16	62.26/63.35 2.451/2.494	59.44 2.340
17	66.22/67.31 2.607/2.650	63.40 2.496
18	70.18/71.27 2.763/2.806	67.36 2.652
19	74.14/75.23 2.919/2.962	71.32 2.808
20	78.11/79.20 3.075/3.118	75.29 2.964
21	82.07/83.16 3.231/3.274	79.25 3.120
22	86.03/87.12 3.387/3.430	83.21 3.276
23	89.94/91.08 3.541/3.586	87.17 3.432
24	93.85/95.00 3.695/3.740	91.14 3.588

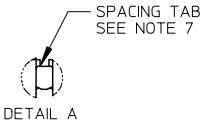
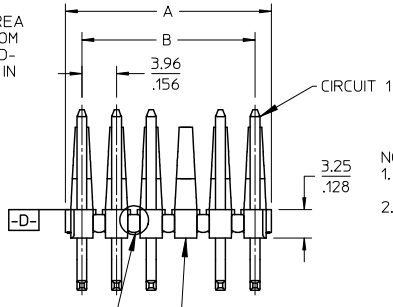
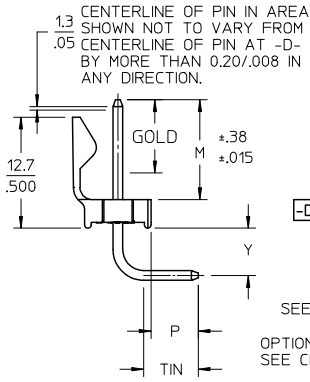

NOTES:
 1. MATERIAL: HEADER: POLYESTER, 94V-0, MOLDED BLACK
 PIN: BRASS
 2. FINISH:
 (102) OVERALL TIN: 0.00508/.000200 MIN OVER
 0.00254/.000100 MIN COPPER.
 (154) OVERALL TIN: 0.00254/.000100 MIN OVER
 0.00127/.000050 MIN NICKEL.
 (208) SELECT GOLD: 0.00038/.000015 MIN.
 *SELECT TIN: 0.00254/.000100 MIN.
 OVERALL NICKEL UNDERPLATE: 0.00127/.000050 MIN.
 (228) SELECT GOLD: 0.00076/.000030 MIN.
 *SELECT TIN: 0.00254/.000100 MIN.
 OVERALL NICKEL UNDERPLATE: 0.00127/.000050 MIN.
 (501) OVERALL GOLD: 0.00051/.000020 MIN OVER
 0.00076/.000030 MIN NICKEL.
 (503) OVERALL GOLD: 0.00076/.000030 MIN OVER
 0.00127/.000050 MIN NICKEL.
 *THE PRIMARY SHIPPING CARTON WILL BE LABELED "COMPLIANT
 TO RoHS DIRECTIVE 2002/95/EC AND ELV ANNEX II OF DIRECTIVE
 2000/53/EC". CARTONS WITHOUT THIS LABEL MAY CONTAIN PRODUCT
 WITH TIN/LEAD PLATINGS.
 3. PRODUCT SPECIFICATION: PS-08-50.
 4. PACKAGING INFORMATION: SEE TABLES
 5. SOLDERABILITY: PER SMES-152.
 6. PIN PUSH-OUT FORCE: PRIOR TO SOLDERING, A 3 LB. MINIMUM
 FORCE IN EITHER DIRECTION SHALL BE REQUIRED TO PUSH THE
 PIN OUT OF THE HEADER.
 7. PARTS ARE STACKABLE END TO END ON 3.96/.156 CENTERS.(SPACING
 TABS MUST BE REMOVED ON CIRCUIT SIZES 1-23 BEFORE PARTS
 ARE STACKABLE.
 8. PARTS WILL CONFORM TO CLASS B REQUIREMENTS OF COSMETIC
 SPECIFICATION PS-45499-002.

OPTIONAL VOIDED CKT.
 SEE CHART FOR LOCATIONS

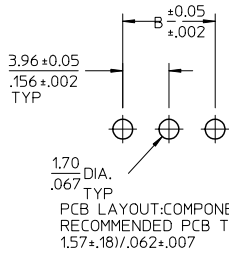

2-*	AB4
1	AB4
SHEET	REV

ADD 41672-0228
 EC NO: UCP2009-2938
 DRWN:MKIPPER 2009/06/12
 CHKD:SSOUSEK 2009/06/15
 APPR:FSMITH 2009/06/15

QUALITY SYMBOLS
 ▽=0
 ▽=0

	GENERAL TOLERANCES (UNLESS SPECIFIED)	
	mm	INCH
4 PLACES	± ---	± ---
3 PLACES	± ---	± .010
2 PLACES	± 0.25	± .015
1 PLACE	± 0.38	± ---
ANGULAR ±1/2°		

DIMENSION STYLE MM/IN
 DRAWN BY JSCHAFFER DATE 12-5-03
 CHECKED BY DATE
 KSAMIEC 12-12-03
 APPROVED BY MARGULIS DATE 12-16-03
 MATERIAL NO. SEE CHART

SCALE 2:1
 DESIGN UNITS INCH
 THIRD ANGLE PROJECTION
 TITLE KK .156 HEADER ASSEMBLY FRICTION LOCK BREAKAWAY RIGHT ANGLE
 MOLEX MOLEX INCORPORATED
 DOCUMENT NO. SD-41672-001

SHEET NO. 1 OF *

DRAFT WHERE APPLICABLE MUST REMAIN WITHIN DIMENSIONS

THIS DRAWING CONTAINS INFORMATION THAT IS PROPRIETARY TO MOLEX INCORPORATED AND SHOULD NOT BE USED WITHOUT WRITTEN PERMISSION

tb_frame_A_P_AM_T
 Rev. D 2004/06/28

5 4 3 2 1

Header No:	41186-A-AN
Pin No:	2161-37(102)
Pin Length L	1.100 / 27.90
Mating M	.450 / 11.43
Gold:	NA
Bend Height: Y	.213 / 5.41
PC Tail P	.212 / 5.38
Tin:	OVERALL
Pack Per	PK-41672-001

Header No:	41186-A-AN
Pin No:	43294-0569
Pin Length L	1.100 / 27.90
Mating M	.450 / 11.43
Gold:	.270 / 6.86
Bend Height: Y	.213 / 5.41
PC Tail P	.212 / 5.38
Tin:	.200 / 5.08
Pack Per	PK-41672-001

Header No:	41186-A-AN
Pin No:	43294-0570
Pin Length L	1.100 / 27.90
Mating M	.450 / 11.43
Gold:	.270 / 6.86
Bend Height: Y	.213 / 5.41
PC Tail P	.212 / 5.38
Tin:	.200 / 5.08
Pack Per	PK-41672-001

Header No:	41186-A-AN
Pin No:	2161-37(501)
Pin Length L	1.100 / 27.90
Mating M	.450 / 11.43
Gold:	OVERALL
Bend Height: Y	.213 / 5.41
PC Tail P	.212 / 5.38
Tin:	NA
Pack Per	PK-41672-001

Ckts	Material No	Engineer Number	Material No	Engineer Number	Material No	Engineer Number	Material No	Engineer Number
2	026481026	A-41672-A02A102	41672-0001	A-41672-B02A208	41672-0024	A-41672-B02A228	026482026	A-41672-A02A501
3	026481036	A-41672-A03A102	41672-0002	A-41672-B03A208	41672-0025	A-41672-B03A228	026482036	A-41672-A03A501
4	026481046	A-41672-A04A102	41672-0003	A-41672-B04A208	41672-0026	A-41672-B04A228	026482046	A-41672-A04A501
5	026481056	A-41672-A05A102	41672-0004	A-41672-B05A208	41672-0027	A-41672-B05A228	026482056	A-41672-A05A501
6	026481066	A-41672-A06A102	41672-0005	A-41672-B06A208	41672-0028	A-41672-B06A228	026482066	A-41672-A06A501
7	026481076	A-41672-A07A102	41672-0006	A-41672-B07A208	41672-0029	A-41672-B07A228	026482076	A-41672-A07A501
8	026481086	A-41672-A08A102	41672-0007	A-41672-B08A208	41672-0030	A-41672-B08A228	026482086	A-41672-A08A501
9	026481096	A-41672-A09A102	41672-0008	A-41672-B09A208	41672-0031	A-41672-B09A228	026482096	A-41672-A09A501
10	026481106	A-41672-A10A102	41672-0009	A-41672-B10A208	41672-0032	A-41672-B10A228	026482106	A-41672-A10A501
11	026481116	A-41672-A11A102	41672-0010	A-41672-B11A208	41672-0033	A-41672-B11A228	026482116	A-41672-A11A501
12	026481126	A-41672-A12A102	41672-0011	A-41672-B12A208	41672-0034	A-41672-B12A228	026482126	A-41672-A12A501
13	026481136	A-41672-A13A102	41672-0012	A-41672-B13A208	41672-0035	A-41672-B13A228	026482136	A-41672-A13A501
14	026481146	A-41672-A14A102	41672-0013	A-41672-B14A208	41672-0036	A-41672-B14A228	026482146	A-41672-A14A501
15	026481156	A-41672-A15A102	41672-0014	A-41672-B15A208	41672-0037	A-41672-B15A228	026482156	A-41672-A15A501
16	026481166	A-41672-A16A102	41672-0015	A-41672-B16A208	41672-0038	A-41672-B16A228	026482166	A-41672-A16A501
17	026481176	A-41672-A17A102	41672-0016	A-41672-B17A208	41672-0039	A-41672-B17A228	026482176	A-41672-A17A501
18	026481186	A-41672-A18A102	41672-0017	A-41672-B18A208	41672-0040	A-41672-B18A228	026482186	A-41672-A18A501
19	026481196	A-41672-A19A102	41672-0018	A-41672-B19A208	41672-0041	A-41672-B19A228	026482196	A-41672-A19A501
20	026481206	A-41672-A20A102	41672-0019	A-41672-B20A208	41672-0042	A-41672-B20A228	026482206	A-41672-A20A501
21	026481216	A-41672-A21A102	41672-0020	A-41672-B21A208	41672-0043	A-41672-B21A228	026482216	A-41672-A21A501
22	026481226	A-41672-A22A102	41672-0021	A-41672-B22A208	41672-0044	A-41672-B22A228	026482226	A-41672-A22A501
23	026481236	A-41672-A23A102	41672-0022	A-41672-B23A208	41672-0045	A-41672-B23A228	026482236	A-41672-A23A501
24	026481246	A-41672-A24A102	41672-0023	A-41672-B24A208	41672-0046	A-41672-B24A228	026482246	A-41672-A24A501

REV: AB4	<u>ECR/ECN INFORMATION:</u>	<u>TITLE:</u> KK 156 HEADER ASSEMBLY FRICTION LOCK BREAKAWAY RIGHT ANGLE	<u>SHEET No.</u> - 2 -
	<u>EC No.:</u> UCP2009-2938		
	<u>DATE:</u> 6/15/2009		
<u>DOCUMENT NUMBER:</u> SD- 41672 -001	<u>CREATED / REVISED BY:</u> MKIPPER	<u>CHECKED BY:</u> SSOUSEK	<u>APPROVED BY:</u> FSMITH
TEMPLATE FILENAME: PRODUCT_SPEC(SIZE_A)(V.1).DOC			

Header No:	41186-A-AN
Pin No:	2161-37(102)
Pin Length L	1.100 / 27.90
Mating M	.523 / 13.28
Gold:	NA
Bend Height: Y	.213 / 5.41
PC Tail P	.136 / 3.45
Tin:	OVERALL
Pack Per	PK-41672-001

Header No:	
Pin No:	
Pin Length L	
Mating M	
Gold:	
Bend Height: Y	
PC Tail P	
Tin:	
Pack Per	

Header No:	41186-A-AN
Pin No:	2161-37(503)
Pin Length L	1.100 / 27.90
Mating M	.450 / 11.43
Gold:	OVERALL
Bend Height: Y	.213 / 5.41
PC Tail P	.212 / 5.38
Tin:	NA
Pack Per	PK-41672-001

Header No:	41186-A-AN
Pin No:	2161-64(102)
Pin Length L	1.175 / 29.85
Mating M	.523 / 13.28
Gold:	NA
Bend Height: Y	.217 / 5.51
PC Tail P	.207 / 5.26
Tin:	OVERALL
Pack Per	PK-41672-001

Ckts	Material No	Engineer Number	Material No	Engineer Number	Material No	Engineer Number	Material No	Engineer Number
2	026582021	A-41672-A02C102			41672-0088	A-41672-A02A503	026486024	A-41672-A02B102
3	41672-0050	A-41672-A03C102			41672-0089	A-41672-A03A503	026486034	A-41672-A03B102
4	026582041	A-41672-A04C102			41672-0090	A-41672-A04A503	026486044	A-41672-A04B102
5	41672-0051	A-41672-A05C102			41672-0091	A-41672-A05A503	026486054	A-41672-A05B102
6	41672-0052	A-41672-A06C102			41672-0092	A-41672-A06A503	026486064	A-41672-A06B102
7	41672-0053	A-41672-A07C102			41672-0093	A-41672-A07A503	026486074	A-41672-A07B102
8	026582081	A-41672-A08C102			41672-0094	A-41672-A08A503	026486084	A-41672-A08B102
9	41672-0054	A-41672-A09C102			41672-0095	A-41672-A09A503	026486094	A-41672-A09B102
10	41672-0055	A-41672-A10C102			026586101	A-41672-A10A503	026486104	A-41672-A10B102
11	41672-0056	A-41672-A11C102			41672-0096	A-41672-A11A503	026486114	A-41672-A11B102
12	41672-0057	A-41672-A12C102			026586121	A-41672-A12A503	026486124	A-41672-A12B102
13	41672-0058	A-41672-A13C102			41672-0097	A-41672-A13A503	026486134	A-41672-A13B102
14	41672-0059	A-41672-A14C102			41672-0098	A-41672-A14A503	026486144	A-41672-A14B102
15	41672-0060	A-41672-A15C102			41672-0099	A-41672-A15A503	026486154	A-41672-A15B102
16	41672-0061	A-41672-A16C102			41672-0100	A-41672-A16A503	026486164	A-41672-A16B102
17	41672-0062	A-41672-A17C102			41672-0101	A-41672-A17A503	026486174	A-41672-A17B102
18	41672-0063	A-41672-A18C102			41672-0102	A-41672-A18A503	026486184	A-41672-A18B102
19	41672-0064	A-41672-A19C102			41672-0103	A-41672-A19A503	026486194	A-41672-A19B102
20	41672-0065	A-41672-A20C102			41672-0104	A-41672-A20A503	026486204	A-41672-A20B102
21	41672-0066	A-41672-A21C102			41672-0105	A-41672-A21A503	026486214	A-41672-A21B102
22	41672-0067	A-41672-A22C102			026586221	A-41672-A22A503	026486224	A-41672-A22B102
23	41672-0068	A-41672-A23C102			41672-0106	A-41672-A23A503	026486234	A-41672-A23B102
24	026582241	A-41672-A24C102			41672-0107	A-41672-A24A503	026486244	A-41672-A24B102

REV: AB4	<u>ECR/ECN INFORMATION:</u>	<u>TITLE:</u> KK 156 HEADER ASSEMBLY FRICTION LOCK BREAKAWAY RIGHT ANGLE	<u>SHEET No.</u> - 3 -
	<u>EC No.:</u> UCP2009-2938 <u>DATE:</u> 6/15/2009		
<u>DOCUMENT NUMBER:</u> SD- 41672 -001	<u>CREATED / REVISED BY:</u> MKIPPER	<u>CHECKED BY:</u> SSOUSEK	<u>APPROVED BY:</u> FSMITH
<small>TEMPLATE FILENAME: PRODUCT_SPEC(SIZE_A)(V.1).DOC</small>			

Header No:	41186-A-AN	Header No:	41186-A-AN	Header No:	41186-A-AN	Header No:	41186-A-AN	
Pin No:	2161-96(501)	Pin No:	2161-37(501)	Pin No:	2161-19(102)	Pin No:	2161-19(102)	
Pin Length L	1.531 / 38.89	Pin Length L	1.100 / 27.90	Pin Length L	1.032 / 26.21	Pin Length L	1.032 / 26.21	
Mating M	.500 / 12.70	Mating M	.523 / 13.28	Mating M	.458/11.63 REF	Mating M	.461 / 11.71	
Gold:	OVERALL	Gold:	OVERALL	Gold:	NA	Gold:	NA	
Bend Height: Y	.213 / 5.41	Bend Height: Y	.213 / 5.41	Bend Height: Y	.221 / 5.61	Bend Height: Y	.213 / 5.41	
PC Tail P	.592 / 15.04	PC Tail P	.136 / 3.45	PC Tail P	.125+- .015	PC Tail P	.130 / 3.30	
Tin:	NA	Tin:	NA	Tin:	OVERALL	Tin:	OVERALL	
Pack Per	PK-41672-001	Pack Per	PK-41672-001	Pack Per	PK-41672-001	Pack Per	PK-41672-001	
Ckts	Material No	Engineer Number	Material No	Engineer Number	Material No	Engineer Number	Material No	Engineer Number
2	41672-0109	A-41672-A02D501	026586020	A-41672-A02C501	026482029	A-41672-A02E102	41672-0151	A-41672-A02F102
3	41672-0110	A-41672-A03D501	026586030	A-41672-A03C501	026482039	A-41672-A03E102	41672-0152	A-41672-A03F102
4	41672-0111	A-41672-A04D501	41672-0131	A-41672-A04C501	026482049	A-41672-A04E102	41672-0153	A-41672-A04F102
5	41672-0112	A-41672-A05D501	41672-0132	A-41672-A05C501	026482059	A-41672-A05E102	41672-0154	A-41672-A05F102
6	41672-0113	A-41672-A06D501	41672-0133	A-41672-A06C501	026482069	A-41672-A06E102	41672-0155	A-41672-A06F102
7	41672-0114	A-41672-A07D501	41672-0134	A-41672-A07C501	026482079	A-41672-A07E102	41672-0156	A-41672-A07F102
8	41672-0115	A-41672-A08D501	026586080	A-41672-A08C501	026482089	A-41672-A08E102	41672-0157	A-41672-A08F102
9	41672-0116	A-41672-A09D501	41672-0135	A-41672-A09C501	026482099	A-41672-A09E102	41672-0158	A-41672-A09F102
10	41672-0117	A-41672-A10D501	41672-0136	A-41672-A10C501	026482109	A-41672-A10E102	41672-0159	A-41672-A10F102
11	41672-0118	A-41672-A11D501	41672-0137	A-41672-A11C501	026482119	A-41672-A11E102	41672-0160	A-41672-A11F102
12	41672-0119	A-41672-A12D501	41672-0138	A-41672-A12C501	026482129	A-41672-A12E102	41672-0161	A-41672-A12F102
13	41672-0120	A-41672-A13D501	41672-0139	A-41672-A13C501	026482139	A-41672-A13E102	41672-0162	A-41672-A13F102
14	41672-0121	A-41672-A14D501	41672-0140	A-41672-A14C501	026482149	A-41672-A14E102	41672-0163	A-41672-A14F102
15	41672-0122	A-41672-A15D501	41672-0141	A-41672-A15C501	026482159	A-41672-A15E102	41672-0164	A-41672-A15F102
16	41672-0123	A-41672-A16D501	41672-0142	A-41672-A16C501	026482169	A-41672-A16E102	41672-0165	A-41672-A16F102
17	41672-0124	A-41672-A17D501	41672-0143	A-41672-A17C501	026482179	A-41672-A17E102	41672-0166	A-41672-A17F102
18	41672-0125	A-41672-A18D501	41672-0144	A-41672-A18C501	026482189	A-41672-A18E102	41672-0167	A-41672-A18F102
19	41672-0126	A-41672-A19D501	41672-0145	A-41672-A19C501	026482199	A-41672-A19E102	41672-0168	A-41672-A19F102
20	41672-0127	A-41672-A20D501	41672-0146	A-41672-A20C501	026482209	A-41672-A20E102	41672-0169	A-41672-A20F102
21	41672-0128	A-41672-A21D501	41672-0147	A-41672-A21C501	026482219	A-41672-A21E102	41672-0170	A-41672-A21F102
22	41672-0129	A-41672-A22D501	41672-0148	A-41672-A22C501	026482229	A-41672-A22E102	41672-0171	A-41672-A22F102
23	41672-0130	A-41672-A23D501	41672-0149	A-41672-A23C501	026482239	A-41672-A23E102	41672-0172	A-41672-A23F102
24	026586242	A-41672-A24D501	41672-0150	A-41672-A24C501	026482249	A-41672-A24E102	41672-0173	A-41672-A24F102

REV: AB4	<u>ECR/ECN INFORMATION:</u>	<u>TITLE:</u> KK 156 HEADER ASSEMBLY FRICTION LOCK BREAKAWAY RIGHT ANGLE	<u>SHEET No.</u> - 4 -
	<u>EC No.:</u> UCP2009-2938		
	<u>DATE:</u> 6/15/2009		
<u>DOCUMENT NUMBER:</u> SD- 41672 -001	<u>CREATED / REVISED BY:</u> MKIPPER	<u>CHECKED BY:</u> SSOUSEK	<u>APPROVED BY:</u> FSMITH

TEMPLATE FILENAME: PRODUCT_SPEC(SIZE_A)(V.1).DOC

<table border="1"> <tr><td>Header No:</td><td>41186-A-AN</td></tr> <tr><td>Pin No:</td><td>2161-52(102)</td></tr> <tr><td>Pin Length L:</td><td>1.063 / 27.00</td></tr> <tr><td>Mating M:</td><td>.450 / 11.43</td></tr> <tr><td>Gold:</td><td>NA</td></tr> <tr><td>Bend Height: Y:</td><td>.213 / 5.41</td></tr> <tr><td>PC Tail P:</td><td>.172 / 4.69</td></tr> <tr><td>Tin:</td><td>OVERALL</td></tr> <tr><td>Pack Per:</td><td>PK-41672-001</td></tr> </table>			Header No:	41186-A-AN	Pin No:	2161-52(102)	Pin Length L:	1.063 / 27.00	Mating M:	.450 / 11.43	Gold:	NA	Bend Height: Y:	.213 / 5.41	PC Tail P:	.172 / 4.69	Tin:	OVERALL	Pack Per:	PK-41672-001	<table border="1"> <tr><td>Header No:</td><td>41186-A-AN</td></tr> <tr><td>Pin No:</td><td>2161-37(102)</td></tr> <tr><td>Pin Length L:</td><td>1.100 / 27.90</td></tr> <tr><td>Mating M:</td><td>.450 / 11.43</td></tr> <tr><td>Gold:</td><td>NA</td></tr> <tr><td>Bend Height: Y:</td><td>.213 / 5.41</td></tr> <tr><td>PC Tail P:</td><td>.212 / 5.38</td></tr> <tr><td>Tin:</td><td>OVERALL</td></tr> <tr><td>Pack Per:</td><td>PK-41672-001</td></tr> </table>			Header No:	41186-A-AN	Pin No:	2161-37(102)	Pin Length L:	1.100 / 27.90	Mating M:	.450 / 11.43	Gold:	NA	Bend Height: Y:	.213 / 5.41	PC Tail P:	.212 / 5.38	Tin:	OVERALL	Pack Per:	PK-41672-001	<table border="1"> <tr><td>Header No:</td><td>41186-A-AN</td></tr> <tr><td>Pin No:</td><td>2161-37(501)</td></tr> <tr><td>Pin Length L:</td><td>1.100 / 27.90</td></tr> <tr><td>Mating M:</td><td>.450 / 11.43</td></tr> <tr><td>Gold:</td><td>OVERALL</td></tr> <tr><td>Bend Height: Y:</td><td>.213 / 5.41</td></tr> <tr><td>PC Tail P:</td><td>.212 / 5.38</td></tr> <tr><td>Tin:</td><td>NA</td></tr> <tr><td>Pack Per:</td><td>PK-41672-001</td></tr> </table>			Header No:	41186-A-AN	Pin No:	2161-37(501)	Pin Length L:	1.100 / 27.90	Mating M:	.450 / 11.43	Gold:	OVERALL	Bend Height: Y:	.213 / 5.41	PC Tail P:	.212 / 5.38	Tin:	NA	Pack Per:	PK-41672-001
Header No:	41186-A-AN																																																													
Pin No:	2161-52(102)																																																													
Pin Length L:	1.063 / 27.00																																																													
Mating M:	.450 / 11.43																																																													
Gold:	NA																																																													
Bend Height: Y:	.213 / 5.41																																																													
PC Tail P:	.172 / 4.69																																																													
Tin:	OVERALL																																																													
Pack Per:	PK-41672-001																																																													
Header No:	41186-A-AN																																																													
Pin No:	2161-37(102)																																																													
Pin Length L:	1.100 / 27.90																																																													
Mating M:	.450 / 11.43																																																													
Gold:	NA																																																													
Bend Height: Y:	.213 / 5.41																																																													
PC Tail P:	.212 / 5.38																																																													
Tin:	OVERALL																																																													
Pack Per:	PK-41672-001																																																													
Header No:	41186-A-AN																																																													
Pin No:	2161-37(501)																																																													
Pin Length L:	1.100 / 27.90																																																													
Mating M:	.450 / 11.43																																																													
Gold:	OVERALL																																																													
Bend Height: Y:	.213 / 5.41																																																													
PC Tail P:	.212 / 5.38																																																													
Tin:	NA																																																													
Pack Per:	PK-41672-001																																																													
Ckts	Material No	Engineer Number	Material No	Engineer Number	Void	Material No	Engineer Number	Void																																																						
2	41672-0176	A-41672-A02G102	026504051	A-41672-A05A102-51	2,4	026504121	A-41672-A12A501-51	4,6																																																						
3	41672-0177	A-41672-A03G102	41672-0047	A-41672-A02A102-1	1	026497063	A-41672-A06A501-5	5																																																						
4	41672-0178	A-41672-A04G102	41672-0174	A-41672-A23A102-51	18,20 ,22																																																									
5	41672-0179	A-41672-A05G102	026504042	A-41672-A04A102-02	2																																																									
6	41672-0180	A-41672-A06G102	026504061	A-41672-A06A102-4	4																																																									
7	41672-0181	A-41672-A07G102	026504043	A-41672-A04A102-3	3																																																									
8	41672-0182	A-41672-A08G102	026504062	A-41672-A06A102-5	5																																																									
9	41672-0183	A-41672-A09G102	416720048	A-41672-A09A102-51	2,3,4, 6,7,8																																																									
10	41672-0184	A-41672-A10G102	416720049	A-41672-A14A102-12	12																																																									
11	41672-0185	A-41672-A11G102	026504102	A-41672-A10A102-5	5																																																									
12	41672-0186	A-41672-A12G102	026504072	A-41672-A07A102-2	2																																																									
13	41672-0187	A-41672-A13G102	41672-0175	A-41672-A11A102-2	2																																																									
14	41672-0188	A-41672-A14G102	41672-0203	A-41672-A14A102-51	2,6, 11,13																																																									
15	41672-0189	A-41672-A15G102	41672-0227	A-41672-A05A102-2	2																																																									
16	41672-0190	A-41672-A16G102																																																												
17	41672-0191	A-41672-A17G102																																																												
18	41672-0192	A-41672-A18G102																																																												
19	41672-0193	A-41672-A19G102																																																												
20	41672-0194	A-41672-A20G102																																																												
21	41672-0195	A-41672-A21G102																																																												
22	41672-0196	A-41672-A22G102																																																												
23	41672-0197	A-41672-A23G102																																																												
24	41672-0198	A-41672-A24G102																																																												

REV: AB4	ECR/ECN INFORMATION:	TITLE: KK 156 HEADER ASSEMBLY FRICTION LOCK BREAKAWAY RIGHT ANGLE	SHEET No. - 5 -
	EC No.: UCP2009-2938		
	DATE: 6/15/2009		
DOCUMENT NUMBER: SD- 41672 -001	CREATED / REVISED BY: MKIPPER	CHECKED BY: SSOUSEK	APPROVED BY: FSMITH

TEMPLATE FILENAME: PRODUCT_SPEC(SIZE_A)(V.1).DOC

Header No:	41186-A-AN		Header No:	41186-A-AN		Header No:		
Pin No:	2161-37(102)		Pin No:	2161-64(102)		Pin No:		
Pin Length L:	1.100 / 27.90		Pin Length L:	1.175 / 29.85		Pin Length L:		
Mating M:	.523 / 13.28		Mating M:	.523 / 13.28		Mating M:		
Gold:	NA		Gold:	NA		Gold:		
Bend Height: Y:	.213 / 5.41		Bend Height: Y:	.217 / 5.51		Bend Height: Y:		
PC Tail P:	.136 / 3.45		PC Tail P:	.207 / 5.26		PC Tail P:		
Tin:	OVERALL		Tin:	OVERALL		Tin:		
Pack Per:	PK-41672-001		Pack Per:	PK-41672-001		Pack Per:		
Material No	Engineer Number	Void	Material No	Engineer Number	Void	Material No	Engineer Number	Void
026504141	A-41672-A14C102-51	2,4,8,12	026504041	A-41672-A04B102-3	3			
			416720108	A-41672-A03B102-3	3			
			026504181	A-41672-A18B102-13	13			
			026504182	A-41672-A18B102-9	9			
			026504101	A-41672-A10B102-7	7			
			026504183	A-41672-A18B102-51	4,11			
			026504184	A-41672-A18B102-52	3,14			
			026504185	A-41672-A18B102-53	4,11,14			

REV: AB4	<u>ECR/ECN INFORMATION:</u>	<u>TITLE:</u> KK 156 HEADER ASSEMBLY FRICTION LOCK BREAKAWAY RIGHT ANGLE	<u>SHEET No.</u>
	<u>EC No.:</u> UCP2009-2938 <u>DATE:</u> 6/15/2009		- 6 -
<u>DOCUMENT NUMBER:</u> SD- 41672 -001	<u>CREATED / REVISED BY:</u> MKIPPER	<u>CHECKED BY:</u> SSOUSEK	<u>APPROVED BY:</u> FSMITH
<small>TEMPLATE FILENAME: PRODUCT_SPEC(SIZE_A)(V.1).DOC</small>			

Header No:	41186-A-AN		Header No:	41186-A-AN		Header No:	41186-A-AN	
Pin No:	2161-19(102)		Pin No:	2161-52(102)		Pin No:	2161-19(154)	
Pin Length L:	1.032 / 26.21		Pin Length L:	1.063 / 27.00		Pin Length L:	1.032 / 26.21	
Mating M:	.461 / 11.71		Mating M:	.450 / 11.43		Mating M:	.458 / 11.63	
Gold:	NA		Gold:	NA		Gold:	NA	
Bend Height: Y:	.213 / 5.41		Bend Height: Y:	.213 / 5.41		Bend Height: Y:	.221 / 5.61	
PC Tail P:	.130 / 3.30		PC Tail P:	.172 / 4.69		PC Tail P:	.125 / 3.18	
Tin:	OVERALL		Tin:	OVERALL		Tin:	OVERALL	
Pack Per:	PK-41672-001		Pack Per:	PK-41672-001		Pack Per:	PK-41672-001	
Material No:	Engineer Number:	Void:	Material No:	Engineer Number:	Void:	Material No:	Engineer Number:	Void:
026504044	A-41672-A04F102-3	3	41672-0199	A-41672-A03G102-1	1	41672-0228	A-41672-A05E154-2	2
			41672-0200	A-41672-A05G102-4	4			
			41672-0201	A-41672-A03G102-3	3			
			41672-0202	A-41672-A05G102-3	3			

REV: AB4	ECR/ECN INFORMATION:		TITLE: KK 156 HEADER ASSEMBLY FRICTION LOCK BREAKAWAY RIGHT ANGLE	SHEET No. - 7 -
	EC No.: UCP2009-2938	DATE: 6/15/2009		
DOCUMENT NUMBER: SD- 41672 -001		CREATED / REVISED BY: MKIPPER	CHECKED BY: SSOUSEK	APPROVED BY: FSMITH

TEMPLATE FILENAME: PRODUCT_SPEC(SIZE_A)(V.1).DOC

Header No:			Header No:			Header No:		
Pin No:			Pin No:			Pin No:		
Pin Length L			Pin Length L			Pin Length L		
Mating M			Mating M			Mating M		
Gold:			Gold:			Gold:		
Bend Height: Y			Bend Height: Y			Bend Height: Y		
PC Tail P			PC Tail P			PC Tail P		
Tin:			Tin:			Tin:		
Pack Per			Pack Per			Pack Per		
Material No	Engineer Number	Void	Material No	Engineer Number	Void	Material No	Engineer Number	Void

REV: AB4	ECR/ECN INFORMATION: EC No.: UCP2009-2938 DATE: 6/15/2009	TITLE: KK 156 HEADER ASSEMBLY FRICTION LOCK BREAKAWAY RIGHT ANGLE	SHEET No. - 8 -
DOCUMENT NUMBER: SD- 41672 -001	CREATED / REVISED BY: MKIPPER	CHECKED BY: SSOUSEK	APPROVED BY: FSMITH

6 5 4 3 2 1

CENTERLINE OF PIN IN AREA SHOWN NOT TO VARY FROM CENTERLINE OF PIN AT -D- BY MORE THAN 0.13/.005 IN ANY DIRECTION.

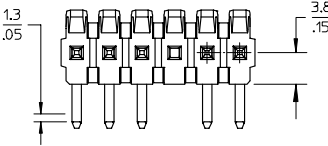

A-41681- * N * * *
 OPTION - PACKING
 A-BRASS - BULK PACK
 B-BRASS - TUBE PACK
 NO OF CKTS
 DIM M.L.P
 PLATING
 VOID LOCATIONS
 BLANK=NO VOIDS
 NO=CKT NO VOIDED
 MULT-VOIDS=51 UP

CIRCUIT	A	B
2	6.78/7.87 .267/1.310	3.96 .156
3	10.74/11.84 .423/1.466	7.92 .312
4	14.71/15.80 .579/1.622	11.89 .468
5	18.67/19.76 .735/1.778	15.85 .624
6	22.63/23.72 .891/1.934	19.81 .780
7	26.59/27.69 1.047/1.090	23.77 .936
8	30.56/31.65 1.203/1.246	27.74 1.092
9	34.52/35.61 1.359/1.402	31.70 1.248
10	38.48/39.57 1.515/1.558	35.66 1.404
11	42.44/43.54 1.671/1.714	39.62 1.560
12	46.41/47.50 1.827/1.870	43.59 1.716
13	50.37/51.46 1.983/2.026	47.55 1.872
14	54.33/55.42 2.139/2.182	51.51 2.028
15	58.29/59.39 2.295/2.338	55.47 2.184
16	62.26/63.35 2.451/2.494	59.44 2.340
17	66.22/67.31 2.607/2.650	63.40 2.496
18	70.18/71.27 2.763/2.806	67.36 2.652
19	74.14/75.23 2.919/2.962	71.32 2.808
20	78.11/79.20 3.075/3.118	75.29 2.964
21	82.07/83.16 3.231/3.274	79.25 3.120
22	86.03/87.12 3.387/3.430	83.21 3.276
23	89.94/91.03 3.541/3.586	87.17 3.432
24	93.85/95.00 3.695/3.740	91.14 3.588

1.3
.05
CENTERLINE OF PIN IN AREA SHOWN NOT TO VARY FROM CENTERLINE OF PIN AT -D- BY MORE THAN 0.20/.008 IN ANY DIRECTION.

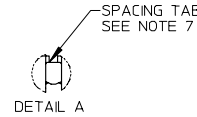
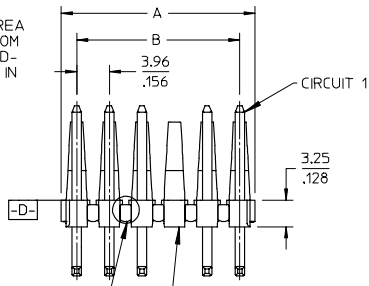
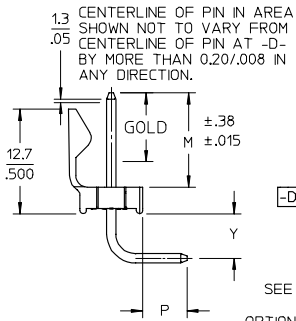

OPTIONAL VOIDED CKT. SEE CHART FOR LOCATIONS

- NOTES:
 1. MATERIAL: HEADER: POLYESTER, 94V-0. MOLDED BLACK
 2. FINISH:
 (228) SELECT GOLD: 0.00076/.00030 MIN.
 *SELECT TIN: 0.00254/.000100 MIN.
 OVERALL NICKEL UNDERPLATE: 0.00127/.000050 MIN.
 *THE PRIMARY SHIPPING CARTON WILL BE LABELED "COMPLIANT TO ROHS DIRECTIVE 2002/95/EC AND ELV ANNEX II OF DIRECTIVE 2000/53/EC". CARTONS WITHOUT THIS LABEL MAY CONTAIN PRODUCT WITH TIN/LEAD PLATINGS.
 3. PRODUCT SPECIFICATION: PS-08-50.
 4. PACKAGING INFORMATION: SEE CHARTS
 5. SOLDERABILITY: PER SMES-152.
 6. PIN PUSH-OUT FORCE: PRIOR TO SOLDERING, A 3 LB. MINIMUM FORCE IN EITHER DIRECTION SHALL BE REQUIRED TO PUSH THE PIN OUT OF THE HEADER.
 7. PARTS ARE STACKABLE END TO END ON 3.96/.156 CENTERS. SPACING TABS MUST BE REMOVED ON CIRCUIT SIZES 1-23 BEFORE PARTS ARE STACKABLE.

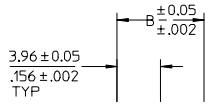

1.70
.067 DIA.
TYP
PCB LAYOUT: COMPONENT SIDE
RECOMMENDED PCB THICKNESS:
(1.57 ± .18) / .062 ± .007

ADD DIMENSION EC NO: UCP2006-2296 2006/04/27 DRAWN/PROJ: JODER CHKD: ADERR 2006/04/28 APPR: F. SMITH 2006/04/28	QUALITY SYMBOLS ▽=0 ▽=0	GENERAL TOLERANCES (UNLESS SPECIFIED)		DIMENSION STYLE MM/IN		SCALE 2:1	DESIGN UNITS INCH	THIRD ANGLE PROJECTION
		4 PLACES ± --- ± ---	3 PLACES ± --- ± .010	2 PLACES ± 0.25 ± .015	1 PLACE ± 0.38 ± ---	ANGULAR ± 1/2°	DRAWN BY JSCHAFFER DATE 12-5-03 CHECKED BY DATE K SAMIEC 12-12-03 APPROVED BY DATE MARGULIS 12-16-03	
DRAFT WHERE APPLICABLE MUST REMAIN WITHIN DIMENSIONS		SEE CHART		MATERIAL NO.			TITLE KK .156 HEADER ASSEMBLY FRICTION LOCK BREAKAWAY RIGHT ANGLE (LEAD-FREE)	
2-* 1 SHEET		A1 A2 REV		MATERIAL NO.		DOCUMENT NO. SD-41672-002		SHEET NO. 1 OF *

tb_frame_A_P_AM_T
Rev. D 2004/06/28

5 4 3 2 1

Ckts	Material No	Engineer Number	Material No	Engineer Number	Material No	Engineer Number	Material No	Engineer Number
2								
3								
4								
5								
6	50-29-1898	A-41672-B06A228						
7								
8								
9								
10								
11								
12								
13								
14								
15								
16								
17								
18								
19								
20								
21								
22								
23								
24								

Header No:	41186-A-AN
Pin No:	43294-0570
Pin Length L:	1.100 / 27.90
Mating M:	.450 / 11.43
Gold:	.270 / 6.86
Bend Height: Y:	.213 / 5.41
PC Tail P:	.212 / 5.38
Tin:	.200 / 5.08
Pack Per:	PK-41672-001

Header No:	
Pin No:	
Pin Length L:	
Mating M:	
Gold:	
Bend Height: Y:	
PC Tail P:	
Tin:	
Pack Per:	

Header No:	
Pin No:	
Pin Length L:	
Mating M:	
Gold:	
Bend Height: Y:	
PC Tail P:	
Tin:	
Pack Per:	

Header No:	
Pin No:	
Pin Length L:	
Mating M:	
Gold:	
Bend Height: Y:	
PC Tail P:	
Tin:	
Pack Per:	

A1	REV: <u>ECR/ECN INFORMATION:</u>	<u>TITLE:</u> KK 156 HEADER ASSEMBLY FRICTION LOCK BREAKAWAY RIGHT ANGLE (LEAD-FREE)	<u>SHEET No.</u> - 2 -	
	EC No.: UCP2006-1776			
	DATE: 4/11/2006			
<u>DOCUMENT NUMBER:</u> SD- 41672 -002		<u>CREATED / REVISED BY:</u> ADERR	<u>CHECKED BY:</u> SSOUSEK	<u>APPROVED BY:</u> FSMITH
TEMPLATE FILENAME: PRODUCT_SPEC(SIZE_A)(V.1).DOC				