

13 12 11 10 9 8 7 6 5 4 3 2 1

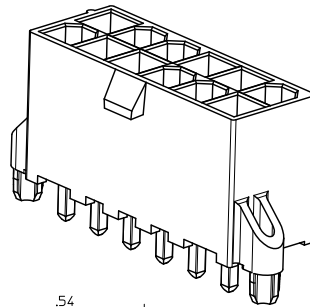

CIRCUIT SIZE	DIM. A	DIM. B	DIM. C
02	NA	0.21/5.4	0.37/9.4
04	0.165/4.20	0.38/9.6	0.535/13.60
06	0.331/8.40	0.54/13.8	0.701/17.80
08	0.496/12.60	0.71/18.0	0.866/22.00
10	0.661/16.80	0.87/22.2	1.031/26.20
12	0.827/21.00	1.04/26.4	1.197/30.40
14	0.992/25.20	1.21/30.6	1.362/34.60
16	1.160/29.40	1.37/34.8	1.528/38.80
18	1.323/33.60	1.54/39.0	1.693/43.00
20	1.488/37.80	1.70/43.2	1.858/47.20
22	1.654/42.00	1.87/47.4	2.024/51.40
24	1.819/46.20	2.03/51.6	2.189/55.60

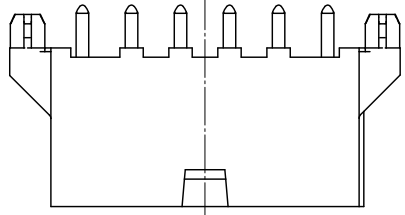
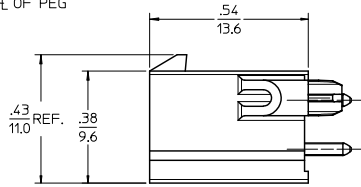
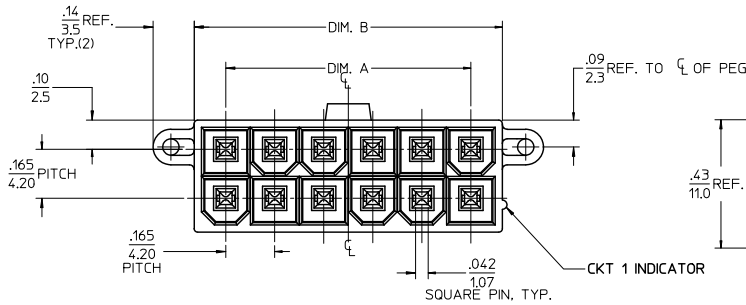

ISOMETRIC VIEW
(12 CKT - SHOWN)

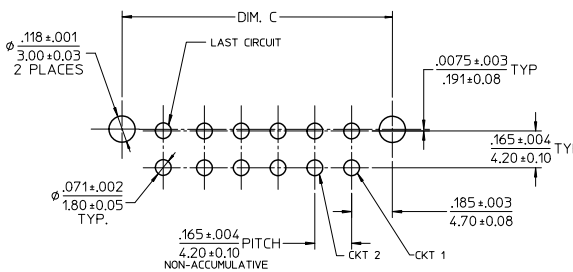
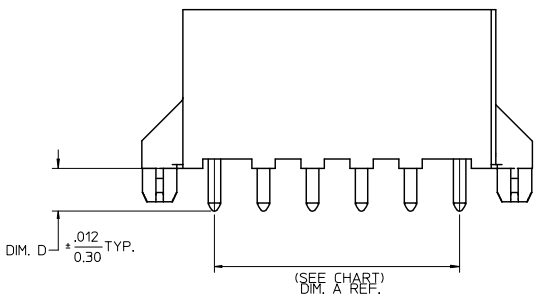

LAYOUT FOR
4-24 CIRCUIT

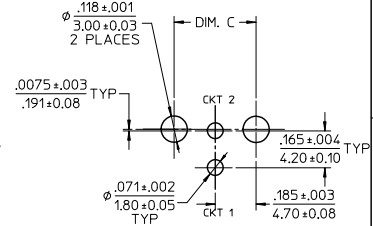

LAYOUT FOR
2 CIRCUIT

RECOMMENDED PCB HOLE LAYOUT COMPONENT SIDE
(SCALE 3:1)

NOTES:

- MATERIALS:
HOUSING - LIQUID CRYSTAL POLYMER (LCP), COLOR: BLACK
TERMINAL - BRASS ALLOY C26000
- TERMINAL PLATING:
TIN= .000100/0.00254 MIN MATTE TIN OVER
.000050/0.00127 MIN NICKEL OVERALL
GOLD= .000030/0.00076 MIN. SELECT GOLD OVER
.000100/0.00254 MIN. SELECT MATTE TIN OVER
.000050/0.00127 MIN NICKEL OVERALL
- PRODUCT SPECIFICATION: PS-46207-001
- PACKAGING SPECIFICATION: TRAY PACK PER PK-46207-001
TAPE AND REEL PACK PER PK-46207-002
- PART CONFORMS TO CLASS "B" REQUIREMENTS OF COSMETIC SPECIFICATION PS-45499-002.

REV	DESCRIPTION	QUALITY SYMBOLS	GENERAL TOLERANCES (UNLESS SPECIFIED)		DIMENSION STYLE IN/MM		SCALE 4:1	DESIGN UNITS METRIC	THIRD ANGLE PROJECTION					
			mm	INCH	DRAWN BY	DATE				TITLE				
D4	ADDED GOLD PIN EC NO. UCP2010-1779 DRAWN: JAGUILAR 2010/08/17/06 CHKD: BELL 2010/08/22/06 APPR: SMITH 2010/08/22/06	▽=0 ▽=0	4 PLACES ±.005 ±.005	3 PLACES ±.013 ±.010	2 PLACES ±.025 ±.025	1 PLACE ±.025 ±.025	ANGULAR ±1/2°	DROSCA 08/07/2006	08/07/2006	BWIRKUS 08/07/2006	BWIRKUS 08/07/2006	MOLEX INCORPORATED	SD-46207-001	SHEET NO. 1 OF 2
DRAFT WHERE APPLICABLE MUST REMAIN WITHIN DIMENSIONS			SEE TABLE		THIS DRAWING CONTAINS INFORMATION THAT IS PROPRIETARY TO MOLEX INCORPORATED AND SHOULD NOT BE USED WITHOUT WRITTEN PERMISSION									

12 11 10 9 8 7 6 5 4 3 2 1

GOLD PLATING					TIN PLATING				
CIRCUIT SIZE	TAPE & REEL MATERIAL NUMBER	TRAY PACKED MATERIAL NUMBER	DIM. D	PCB THICKNESS	CIRCUIT SIZE	TAPE & REEL MATERIAL NUMBER	TRAY PACKED MATERIAL NUMBER	DIM. D	PCB THICKNESS
02	462077002	* 462075002	* 0.144/3.66	0.062	02	462073002	* 462070002	* 0.144/3.66	0.062
04	462077004	* 462075004	* 0.144/3.66	0.062	04	462073004	* 462070004	* 0.144/3.66	0.062
06	462077006	* 462075006	* 0.144/3.66	0.062	06	462073006	* 462070006	* 0.144/3.66	0.062
08	462077008	* 462075008	* 0.144/3.66	0.062	08	462073008	* 462070008	* 0.144/3.66	0.062
10	462077010	* 462075010	* 0.144/3.66	0.062	10	462073010	* 462070010	* 0.144/3.66	0.062
12	462077012	* 462075012	* 0.144/3.66	0.062	12	462073012	* 462070012	* 0.144/3.66	0.062
14	462077014	* 462075014	* 0.144/3.66	0.062	14	462073014	* 462070014	* 0.144/3.66	0.062
16	462077016	* 462075016	* 0.144/3.66	0.062	16	462073016	* 462070016	* 0.144/3.66	0.062
18	462077018	* 462075018	* 0.144/3.66	0.062	18	462073018	* 462070018	* 0.144/3.66	0.062
20	462077020	* 462075020	* 0.144/3.66	0.062	20	462073020	* 462070020	* 0.144/3.66	0.062
22	462077022	* 462075022	* 0.144/3.66	0.062	22	462073022	* 462070022	* 0.144/3.66	0.062
24	462077024	* 462075024	* 0.144/3.66	0.062	24	462073024	* 462070024	* 0.144/3.66	0.062
02					02		462070102	* 0.176/4.46	0.093
04					04		462070104	* 0.176/4.46	0.093
06					06		462070106	* 0.176/4.46	0.093
08					08		462070108	* 0.176/4.46	0.093
10					10		462070110	* 0.176/4.46	0.093
12					12		462070112	* 0.176/4.46	0.093
14					14		462070114	* 0.176/4.46	0.093
16					16		462070116	* 0.176/4.46	0.093
18					18		462070118	* 0.176/4.46	0.093
20					20		462070120	* 0.176/4.46	0.093
22					22		462070122	* 0.176/4.46	0.093
24					24		462070124	* 0.176/4.46	0.093
02					02		462070202	* 0.207/5.26	0.125
04					04		462070204	* 0.207/5.26	0.125
06					06		462070206	* 0.207/5.26	0.125
08					08		462070208	* 0.207/5.26	0.125
10					10		462070210	* 0.207/5.26	0.125
12					12		462070212	* 0.207/5.26	0.125
14					14		462070214	* 0.207/5.26	0.125
16					16		462070216	* 0.207/5.26	0.125
18					18		462070218	* 0.207/5.26	0.125
20					20		462070220	* 0.207/5.26	0.125
22					22		462070222	* 0.207/5.26	0.125
24					24		462070224	* 0.207/5.26	0.125

* DESIGNATES PART NOT RELEASED CONTACT FACTORY FOR AVAILABILITY.

* DESIGNATES PART NOT RELEASED CONTACT FACTORY FOR AVAILABILITY.

SEE SHEET 1 EC NO. UEP2010-1779 DRW: JAGUILAR 20/08/2006 CHK: BELL 20/08/22 APPR: SMITH 20/08/22	QUALITY SYMBOLS 	GENERAL TOLERANCES (UNLESS SPECIFIED)		DIMENSION STYLE		SCALE	DESIGN UNITS	THIRD ANGLE PROJECTION 		
				IN/MM		1:1	METRIC			
		DRAWN BY		DATE	TITLE		MATERIAL NO.		DOCUMENT NO.	
		DRAFT WHERE APPLICABLE MUST REMAIN WITHIN DIMENSIONS		08/07/2006	MINI-FIT RTC HI-TEMP VERTICAL HEADER IN LCP, W/PCB PEGS		SD-46207-001		SHEET NO. 2 OF 2	
		CHECKED BY		DATE	APPROVED BY		DATE	MOLEX INCORPORATED THIS DRAWING CONTAINS INFORMATION THAT IS PROPRIETARY TO MOLEX INCORPORATED AND SHOULD NOT BE USED WITHOUT WRITTEN PERMISSION		
		08/07/2006		08/07/2006	08/07/2006					