

REV.	DESCRIPTION	DATE
A	NEW DRAWING	4/12/2006
B	dimension updates from 1.5, 12.2, 19.2 & 22.3 to 1.7, 12.0, 19.0, & 22.2	6/24/2008

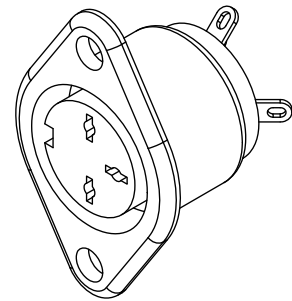

TOLERANCE:
X.X ±0.1mm
X.XX ±0.05mm

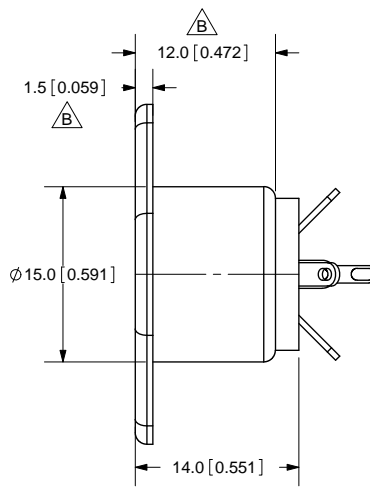
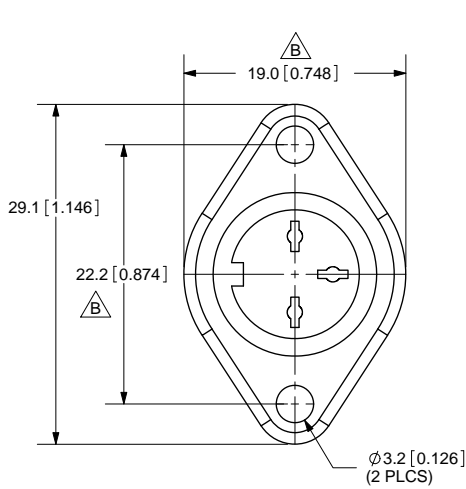

SPECIFICATIONS:
RATING: 100V AC @ 2A
CONTACT RESISTANCE: 20m OHMS MAX
INSULATION RESISTANCE: 300M OHMS MIN; 500V DC
VOLTAGE WITHSTAND: 1000V AC R.M.S. FOR 1 MINUTE
INSERTION FORCE: 4.0KG MAX
WITHDRAWAL FORCE: 1.0KG~3.5KG
WIRE AWG 22~26
LIFE: 5,000 CYCLES



20050 SW 112th Ave.
Tualatin, OR 97062
Phone: 503-612-2300
800-275-4899
Fax: 503-612-2383
Website: www.cui.com

	MATERIAL	PLATING
SOCKET CASE	Steel	Nickel
EARTH TERMINAL	Phosphor Bronze	
CONTACT PIN	Brass	Silver
RIVET	Aluminum	Nickel
INSULATOR	PBT	

TITLE: PANEL MOUNT DIN SOCKET		REV: B
PART NO. SD-30SN	UNITS: MM [INCHES]	
DRAWN BY: ZRJ	APPROVED BY:	SCALE: 2:1

PC FILE NAME:
SD-30SN

COPYRIGHT 2008 BY CUI INC.