

4

3

2

1

THIS DRAWING IS UNPUBLISHED. RELEASED FOR PUBLICATION
 BY TYCO ELECTRONICS CORPORATION. ALL RIGHTS RESERVED.

MATERIAL:
 RECEPTACLE HOUSING, UL 94V-0 RATED THERMOPLASTIC, COLOR:SEE TABLE
 CONTACT, PHOSPHOR BRONZE
 FRONT NUT, UL 94V-0 RATED THERMOPLASTIC, COLOR:SEE TABLE
 HEX NUT, BRASS

FINISH:
 CONTACT, 0.75µm MIN. GOLD OVER NICKEL
 HEX NUT, NICKEL

SOLDER TERMINATION CONTACT, 28 AWG WIRE MAX.

10.0 MAXIMUM PANEL THICKNESS

5. INSTALLS FROM FRONT OR REAR OF PANEL

INGRESS PROTECTION: IP50 (MATED)

PRELIMINARY PART NUMBER.

REV	DATE	BY	CHKD	APPROV
A	ECO-07-010931	10M172007	RB	DR
B	ECO-07-029395	120C2007	RB	DR
B1	REVISED PER ECO-08-011256	10M172008	SS	DR
B2	REVISED PER ECO-09-008097	08M192009	MF	DR

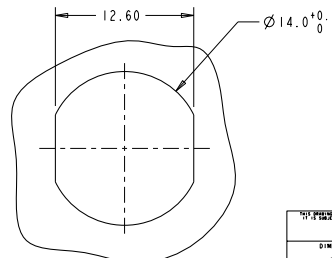
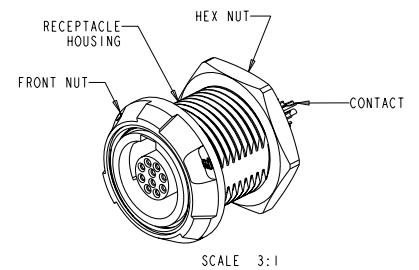
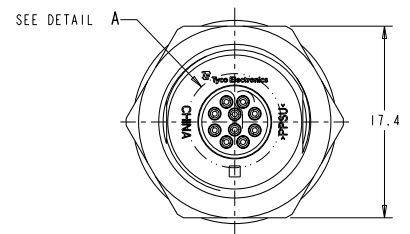
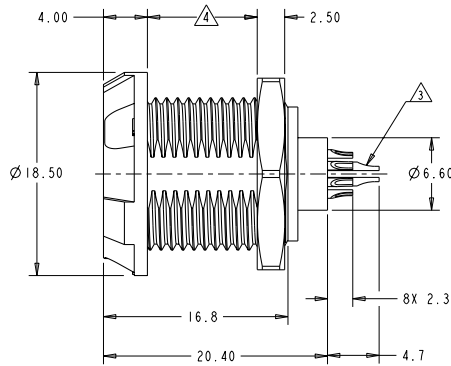
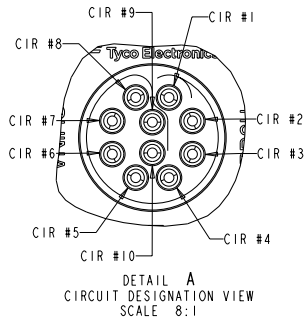

DIMENSIONS: mm 		TOLERANCES UNLESS OTHERWISE SPECIFIED: ANGLES ° ±0.2 ° ±0.05 ° ±0.1 ° ±0.5		DWG NO. 22JUN2005 R. L. KOLLER 28JUN2005 C. L. BREKOSKY		Tyco Electronics Harrisburg, PA 17105-3608	
MATERIAL FINISH △ - △ -		PRODUCT SPEC 108-2249 APPLICATION SPEC 114-13184		SHEET CASE CODE DRAWING NO. A2 00779 ©-1877069		RESTRICTED TO CUSTOMER DRAWING SCALE 5:1 SHEET 1 OF 2 REV B2	

4

3

2

1

THIS DRAWING IS UNPUBLISHED. RELEASED FOR PUBLICATION BY TYCO ELECTRONICS CORPORATION. ALL RIGHTS RESERVED. COPYRIGHT 20

LOC	DIST	REV	DESCRIPTION	DATE	BY	APPV
AD	00					
			SEE SHEET 1			

KEYING	FRONT NUT COLOR	HOUSING COLOR	PART NUMBER
40°	BLUE	BLACK	4-1877069-2
	BLUE	GRAY	4-1877069-1
40°	GREEN	BLACK	4-1877069-0
	GREEN	GRAY	3-1877069-9
40°	YELLOW	BLACK	3-1877069-8
	YELLOW	GRAY	3-1877069-7
40°	WHITE	BLACK	3-1877069-6
	WHITE	GRAY	3-1877069-5
40°	RED	BLACK	3-1877069-4
	RED	GRAY	3-1877069-3
40°	BLACK	BLACK	3-1877069-2
	BLACK	GRAY	3-1877069-1
40°	GRAY	BLACK	3-1877069-0
	GRAY	GRAY	2-1877069-9
80°	BLACK	GRAY	2-1877069-8
	GRAY	BLACK	2-1877069-7
0°	BLACK	GRAY	2-1877069-6
	GRAY	BLACK	2-1877069-5
80°	BLUE	BLACK	2-1877069-4
	BLUE	GRAY	2-1877069-3
0°	BLUE	BLACK	2-1877069-2
	BLUE	GRAY	2-1877069-1
80°	GREEN	BLACK	2-1877069-0
	GREEN	GRAY	1-1877069-9
0°	GREEN	BLACK	1-1877069-8
	GREEN	GRAY	1-1877069-7
80°	YELLOW	BLACK	1-1877069-6
	YELLOW	GRAY	1-1877069-5
0°	YELLOW	BLACK	1-1877069-4
	YELLOW	GRAY	1-1877069-3
80°	WHITE	BLACK	1-1877069-2
	WHITE	GRAY	1-1877069-1
0°	WHITE	BLACK	1-1877069-0
	WHITE	GRAY	1877069-9
80°	RED	BLACK	1877069-8
	RED	GRAY	1877069-7
0°	RED	BLACK	1877069-6
	RED	GRAY	1877069-5
80°	BLACK	BLACK	1877069-4
	GRAY	GRAY	1877069-3
0°	BLACK	BLACK	1877069-2
	GRAY	GRAY	1877069-1

60°	BLUE	BLACK	5-1877069-6
	BLUE	GRAY	5-1877069-5
60°	GREEN	BLACK	5-1877069-4
	GREEN	GRAY	5-1877069-3
60°	YELLOW	BLACK	5-1877069-2
	YELLOW	GRAY	5-1877069-1
60°	WHITE	BLACK	5-1877069-0
	WHITE	GRAY	4-1877069-9
60°	RED	BLACK	4-1877069-8
	RED	GRAY	4-1877069-7
60°	BLACK	BLACK	4-1877069-6
	BLACK	GRAY	4-1877069-5
60°	GRAY	BLACK	4-1877069-4
	GRAY	GRAY	4-1877069-3

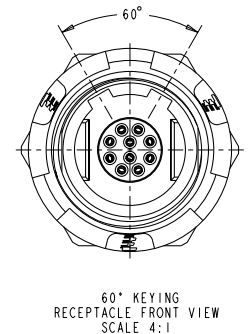
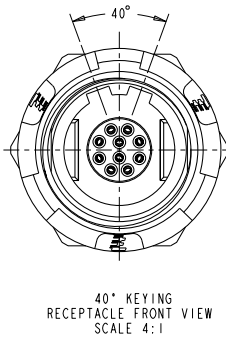
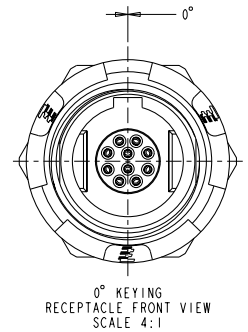
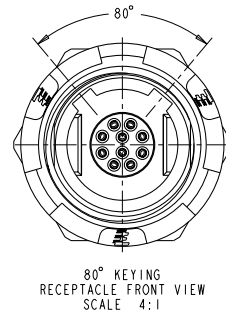

DIMENSIONS: mm 		0 PLC 80° 1 PLC 80-2 2 PLC 80-08 3 PLC 80° 4 PLC 80° ANGLES 81°	DATE: 22 JUN 2005 DRN: R. L. KOLLER CHK: B. BROSZY DATE: 28 JUN 2005 NAME:	Tyco Electronics Harrisburg, PA 17105-3608
MATERIAL: - / FINISH: -		PRODUCT SPEC: 108-2249 APPLICATION SPEC: 114-13184	SHEET: A2 CASE CODE: 00779 DRAWING NO: ©-1877069	RESTRICTED TO: - SCALE: 5:1 SHEET: 2 OF 2 REV: B2