

4 3 2 1

THIS DRAWING IS UNPUBLISHED. RELEASED FOR PUBLICATION BY TYCO ELECTRONICS CORPORATION. ALL RIGHTS RESERVED. COPYRIGHT 20

- △ MATERIAL:
RECEPTACLE HOUSING, UL 94V-0 RATED THERMOPLASTIC, COLOR:SEE TABLE
CONTACT, PHOSPHOR BRONZE
FRONT NUT, UL 94V-0 RATED THERMOPLASTIC, COLOR:SEE TABLE
HEX NUT, BRASS
- △ FINISH:
CONTACT, 0.75µm MIN. GOLD OVER NICKEL
HEX NUT, NICKEL
- △ SOLDER TERMINATION CONTACT, 22 AWG WIRE MAX.
- △ 10.0 MAXIMUM PANEL THICKNESS
- 5. INSTALLS FROM FRONT OR REAR OF PANEL
- 6. INGRESS PROTECTION: IP50 (MATED)
- △ PRELIMINARY PART NUMBER.

REV	DATE	BY	CHKD	APPROV
A	ECO-07-010931	10M172007	RB	DR
B	ECO-07-029395	1206C2007	RB	DR
B1	REVISED PER ECO-08-011256	10M172008	SS	DR
B2	REVISED PER ECO-09-008097	04M192009	MF	DR

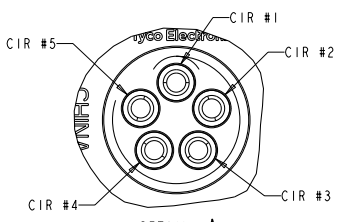
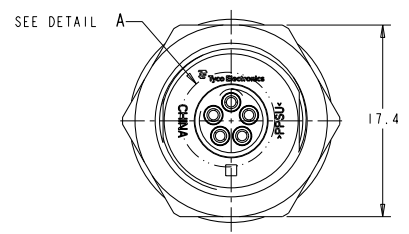
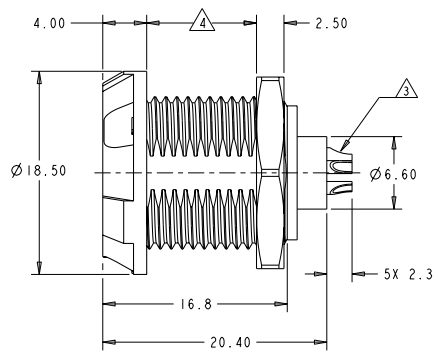

DETAIL A
CIRCUIT DESIGNATION VIEW
SCALE 8:1

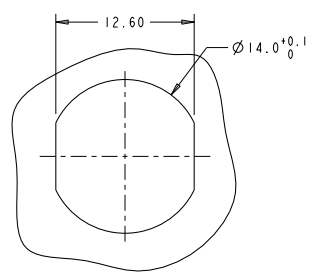

SUGGESTED
PANEL CUTOUT
SCALE 4:1

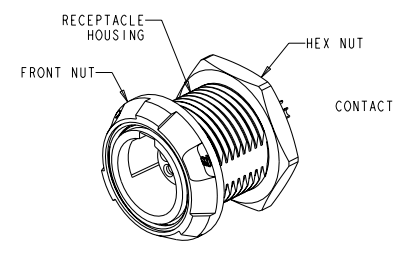

SCALE 3:1

DIMENSIONS: mm 		TO BE USED IN CONJUNCTION WITH THE RECEPTACLE HOUSING DRAWING FOR THE CORRECT POSITION. OPERATING SPECIFICATIONS: 0 PLC 20-2 1 PLC 20-2 2 PLC 20-20 3 PLC 20-20 4 PLC 20-20 ANGLES 20-20		DATE: 17 JUN 2005 BY: R. L. KOLLER CHKD: B. B. KOSKY APPROV:		Tyco Electronics Harrisburg, PA 17105-3608	
MATERIAL: △ - FINISH: △ -		PRODUCT SPEC: 108-2249 APPLICATION SPEC: 114-13184 WEIGHT: - CUSTOMER DRAWING		NAME: RECEPTACLE ASSEMBLY PANEL MOUNT 5 POSITION		SHEET: A2 CASE CODE: 00779 DRAWING NO: 1877066 RESTRICTED TO: - SCALE: 5:1 SHEET: 1 OF 2 REV: B2	

4

3

2

1

THIS DRAWING IS UNPUBLISHED. RELEASED FOR PUBLICATION BY TYCO ELECTRONICS CORPORATION. ALL RIGHTS RESERVED. COPYRIGHT 20

LOC	DISP	REV	DESCRIPTION	DATE	BY	APPV
AD	00					
			SEE SHEET 1			

KEYING	FRONT NUT COLOR	HOUSING COLOR	PART NUMBER
40°	BLUE	BLACK	4-1877066-2
	BLUE	GRAY	4-1877066-1
40°	GREEN	BLACK	4-1877066-0
	GREEN	GRAY	3-1877066-9
40°	YELLOW	BLACK	3-1877066-8
	YELLOW	GRAY	3-1877066-7
40°	WHITE	BLACK	3-1877066-6
	WHITE	GRAY	3-1877066-5
40°	RED	BLACK	3-1877066-4
	RED	GRAY	3-1877066-3
40°	BLACK	BLACK	3-1877066-2
	BLACK	GRAY	3-1877066-1
40°	GRAY	BLACK	3-1877066-0
	GRAY	GRAY	2-1877066-9
80°	BLACK	GRAY	2-1877066-8
	GRAY	BLACK	2-1877066-7
0°	BLACK	GRAY	2-1877066-6
	GRAY	BLACK	2-1877066-5
80°	BLUE	BLACK	2-1877066-4
	BLUE	GRAY	2-1877066-3
0°	BLUE	BLACK	2-1877066-2
	BLUE	GRAY	2-1877066-1
80°	GREEN	BLACK	2-1877066-0
	GREEN	GRAY	1-1877066-9
0°	GREEN	BLACK	1-1877066-8
	GREEN	GRAY	1-1877066-7
80°	YELLOW	BLACK	1-1877066-6
	YELLOW	GRAY	1-1877066-5
0°	YELLOW	BLACK	1-1877066-4
	YELLOW	GRAY	1-1877066-3
80°	WHITE	BLACK	1-1877066-2
	WHITE	GRAY	1-1877066-1
0°	WHITE	BLACK	1-1877066-0
	WHITE	GRAY	1877066-9
80°	RED	BLACK	1877066-8
	RED	GRAY	1877066-7
0°	RED	BLACK	1877066-6
	RED	GRAY	1877066-5
80°	BLACK	BLACK	1877066-4
	GRAY	GRAY	1877066-3
0°	BLACK	BLACK	1877066-2
	GRAY	GRAY	1877066-1

KEYING	FRONT NUT COLOR	HOUSING COLOR	PART NUMBER
60°	BLUE	BLACK	5-1877066-6
	BLUE	GRAY	5-1877066-5
60°	GREEN	BLACK	5-1877066-4
	GREEN	GRAY	5-1877066-3
60°	YELLOW	BLACK	5-1877066-2
	YELLOW	GRAY	5-1877066-1
60°	WHITE	BLACK	5-1877066-0
	WHITE	GRAY	4-1877066-9
60°	RED	BLACK	4-1877066-8
	RED	GRAY	4-1877066-7
60°	BLACK	BLACK	4-1877066-6
	BLACK	GRAY	4-1877066-5
60°	GRAY	BLACK	4-1877066-4
	GRAY	GRAY	4-1877066-3

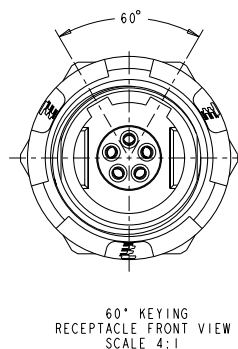
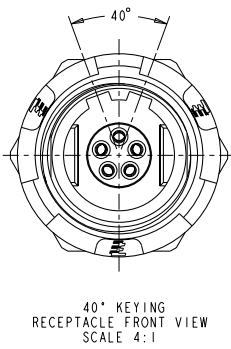
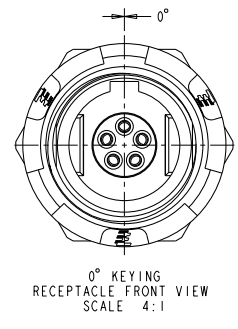
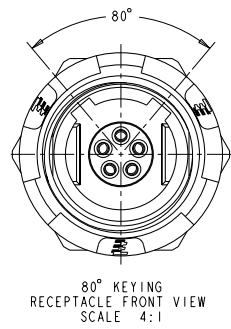

<small>THE DIMENSIONS SHOWN ARE UNLESS OTHERWISE SPECIFIED IN MILLIMETERS. DIMENSIONS IN PARENTHESES ARE IN INCHES. DIMENSIONS IN PARENTHESES ARE FOR THE LOCAL MARKET.</small>		DWG: R.L. KOLLER 17 JUN 2005 CHK: B.BEKOSKY 28 JUN 2005	Tyco Electronics Harrisburg, PA 17105-3608
DIMENSIONS: mm	TO BE MADE TO ORDER OPERATING SPECIFICATIONS: 0 PLC 20° 1 PLC 20-2 2 PLC 20-20 3 PLC 20° 4 PLC 20° ANGLES 20°	PRODUCT SPEC: 108-2249 APPLICATION SPEC: 114-13184	NAME: RECEPTACLE ASSEMBLY PANEL MOUNT 5 POSITION
MATERIAL:	FINISH:	WEIGHT:	SIZE: A2 CASE CODE: 00779 DRAWING NO: 1877066
CUSTOMER DRAWING		SCALE: 5:1	RESTRICTED TO: REV B2