

REV.	DESCRIPTION	DATE
A	NEW DRAWING	9/1/2006

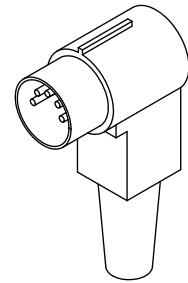

TOLERANCE:
 X.X ±0.2mm
 X.XX ±0.1mm
 X.XXX ±0.05mm

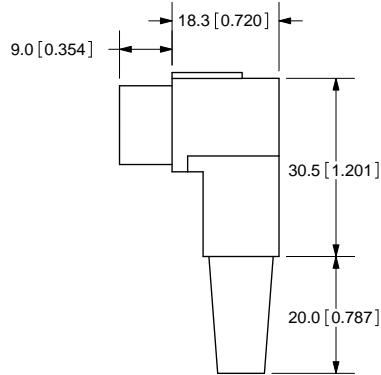
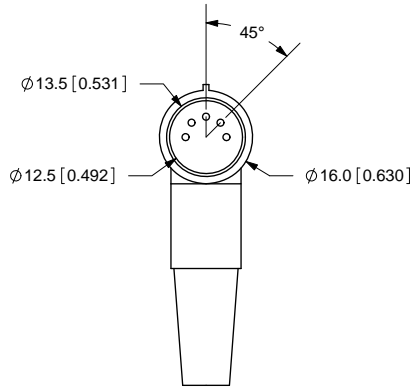

SPECIFICATIONS:
 RATING: 100V AC @ 1A
 CONTACT RESISTANCE: 30m OHMS MAX
 INSULATION RESISTANCE: 100M OHMS MIN: 500V DC
 VOLTAGE WITHSTAND: 250V AC R.M.S. FOR 1 MINUTE
 LIFE: 5,000 CYCLES
 OPERATING TEMP: -20° ~ +70°C



20050 SW 112th Ave.
 Tualatin, OR 97062
 Phone: 503-612-2300
 800-275-4899
 Fax: 503-612-2383
 Website: www.cui.com

	MATERIAL	PLATING
PINS	Brass	Nickel
CONTACT 1	Steel	Nickel
CONTACT 2	Steel	Nickel
CAP	Polyethylene	
INSULATOR	ABS	

TITLE: DIN PLUG		REV: A
PART NO. SDR-50	UNITS: MM [INCHES]	
DRAWN BY: ZRJ	APPROVED BY:	SCALE: 1:1

PC FILE NAME: SDR-50

COPYRIGHT 2009 BY CUI INC.