

SMDA05-6R2

Unidirectional TVS Array for High-Speed Data Line Protection

The SMDA05-6R2 transient voltage suppressor is designed to protect equipment attached to up to six high speed communication lines from ESD, EFT, and lightning.

Features:

- SO-8 Package
- Peak Power – 400 Watts 8 x 20 μ S
- ESD Rating:
IEC 61000-4-2 (ESD) 15 kV (air) 8 kV (contact)
IEC 61000-4-4 (EFT) 40 A (5/50 ns)
IEC 61000-4-5 (lightning) 12 (8/20 μ s)
- UL Flammability Rating of 94 V-0

Typical Applications:

- High Speed Communication Line Protection
- 5.0 V Data and I/O Lines
- Microprocessor Based Equipment
- LAN/WAN Equipment
- Servers
- Notebook and Desktop PC
- Instrumentation
- Peripherals

MAXIMUM RATINGS

Rating	Symbol	Value	Unit
Peak Power Dissipation 8 x 20 μ s @ $T_A = 25^\circ\text{C}$ (Note 1)	P_{pk}	400	W
Peak Pulse Current 8 x 20 μ s @ $T_A = 25^\circ\text{C}$ (Note 1)	I_{pp}	17	A
Junction and Storage Temperature Range	T_J, T_{stg}	-55 to +150	$^\circ\text{C}$
Lead Solder Temperature – Maximum 10 Seconds Duration	T_L	260	$^\circ\text{C}$

1. Non-repetitive current pulse 8 x 20 μ S exponential decay waveform



ON Semiconductor®

<http://onsemi.com>

**SO-8
VOLTAGE SUPPRESSOR
300 WATTS PEAK POWER
6 VOLTS**

PIN CONFIGURATION AND SCHEMATIC

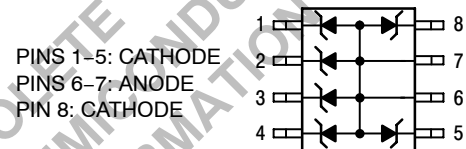

**SO-8
CASE 751
PLASTIC**

MARKING DIAGRAM

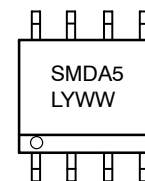

SMDA5 = Device Code
L = Location Code
Y = Year
WW = Work Week

ORDERING INFORMATION

Device	Package	Shipping†
SMDA05-6R2	SO-8	2500 Tape & Reel

†For information on tape and reel specifications, including part orientation and tape sizes, please refer to our Tape and Reel Packaging Specification Brochure, BRD8011/D.

SMDA05-6R2

ELECTRICAL CHARACTERISTICS

Characteristic	Symbol	Min	Typ	Max	Unit
Reverse Breakdown Voltage @ $I_t = 1.0 \text{ mA}$	V_{BR}	6.0	-	-	V
Reverse Leakage Current @ $V_{RWM} = 5.0 \text{ Volts}$	I_R	N/A	-	20	μA
Maximum Clamping Voltage @ $I_{PP} = 1.0 \text{ A}, 8 \times 20 \mu\text{S}$	V_C	N/A	-	9.8	V
Maximum Clamping Voltage @ $I_{PP} = 5.0 \text{ A}, 8 \times 20 \mu\text{S}$	V_C	N/A	-	11	V
Maximum Peak Pulse Current	I_{PP}	-	-	17	A

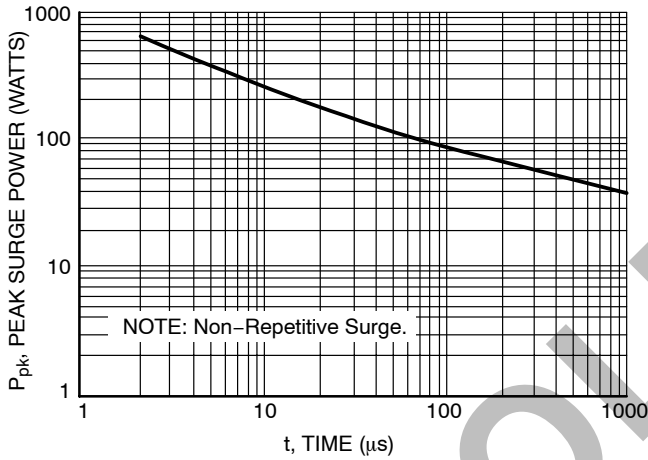

Figure 1. Pulse Width

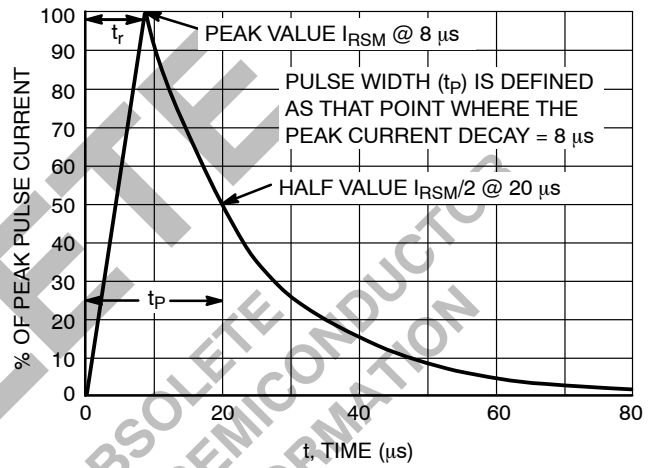
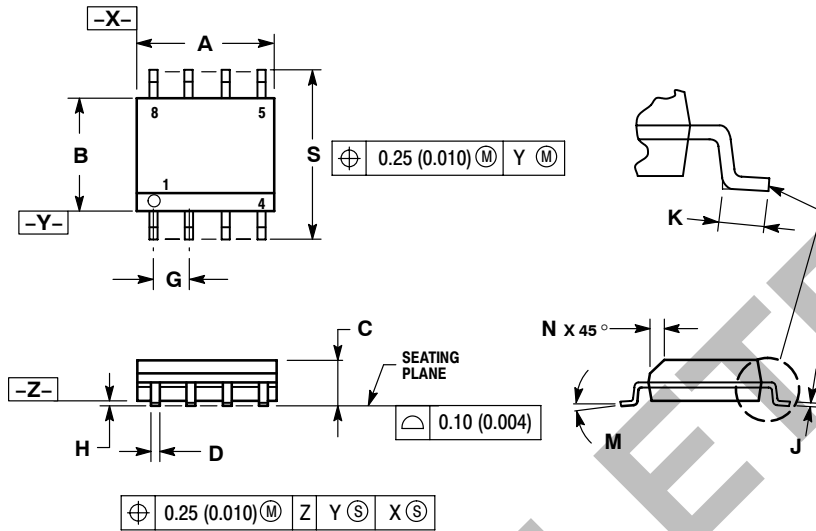

Figure 2. $8 \times 20 \mu\text{s}$ Pulse Waveform

SMDA05-6R2

PACKAGE DIMENSIONS

SO-8
CASE 751-07
ISSUE AB



NOTES:

1. DIMENSIONING AND TOLERANCING PER ANSI Y14.5M, 1982.
2. CONTROLLING DIMENSION: MILLIMETER.
3. DIMENSION A AND B DO NOT INCLUDE MOLD PROTRUSION.
4. MAXIMUM MOLD PROTRUSION 0.15 (0.006) PER SIDE.
5. DIMENSION D DOES NOT INCLUDE DAMBAR PROTRUSION. ALLOWABLE DAMBAR PROTRUSION SHALL BE 0.127 (0.005) TOTAL IN EXCESS OF THE D DIMENSION AT MAXIMUM MATERIAL CONDITION.
6. 751-01 THRU 751-06 ARE OBSOLETE. NEW STANDAARD IS 751-07

DIM	MILLIMETERS		INCHES	
	MIN	MAX	MIN	MAX
A	4.80	5.00	0.189	0.197
B	3.80	4.00	0.150	0.157
C	1.35	1.75	0.053	0.069
D	0.33	0.51	0.013	0.020
G	1.27 BSC		0.050 BSC	
H	0.10	0.25	0.004	0.010
J	0.19	0.25	0.007	0.010
K	0.40	1.27	0.016	0.050
M	0°	8°	0°	8°
N	0.25	0.50	0.010	0.020
S	5.80	6.20	0.228	0.244

SOLDERING FOOTPRINT*

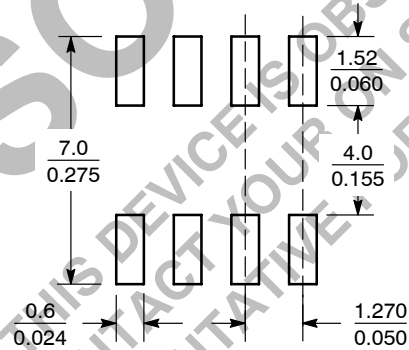

SCALE 6:1 ($\frac{\text{mm}}{\text{inches}}$)

*For additional information on our Pb-Free strategy and soldering details, please download the ON Semiconductor Soldering and Mounting Techniques Reference Manual, SOLDERRM/D.

OBSOLETE
 THIS DEVICE IS OBSOLETE
 PLEASE CONTACT YOUR ON SEMICONDUCTOR
 REPRESENTATIVE FOR INFORMATION

ON Semiconductor and  are registered trademarks of Semiconductor Components Industries, LLC (SCILLC). SCILLC reserves the right to make changes without further notice to any products herein. SCILLC makes no warranty, representation or guarantee regarding the suitability of its products for any particular purpose, nor does SCILLC assume any liability arising out of the application or use of any product or circuit, and specifically disclaims any and all liability, including without limitation special, consequential or incidental damages. "Typical" parameters which may be provided in SCILLC data sheets and/or specifications can and do vary in different applications and actual performance may vary over time. All operating parameters, including "Typicals" must be validated for each customer application by customer's technical experts. SCILLC does not convey any license under its patent rights nor the rights of others. SCILLC products are not designed, intended, or authorized for use as components in systems intended for surgical implant into the body, or other applications intended to support or sustain life, or for any other application in which the failure of the SCILLC product could create a situation where personal injury or death may occur. Should Buyer purchase or use SCILLC products for any such unintended or unauthorized application, Buyer shall indemnify and hold SCILLC and its officers, employees, subsidiaries, affiliates, and distributors harmless against all claims, costs, damages, and expenses, and reasonable attorney fees arising out of, directly or indirectly, any claim of personal injury or death associated with such unintended or unauthorized use, even if such claim alleges that SCILLC was negligent regarding the design or manufacture of the part. SCILLC is an Equal Opportunity/Affirmative Action Employer. This literature is subject to all applicable copyright laws and is not for resale in any manner.

PUBLICATION ORDERING INFORMATION

LITERATURE FULFILLMENT:

Literature Distribution Center for ON Semiconductor
 P.O. Box 5163, Denver, Colorado 80217 USA

Phone: 303-675-2175 or 800-344-3860 Toll Free USA/Canada

Fax: 303-675-2176 or 800-344-3867 Toll Free USA/Canada

Email: orderlit@onsemi.com

N. American Technical Support: 800-282-9855 Toll Free
 USA/Canada

Japan: ON Semiconductor, Japan Customer Focus Center

2-9-1 Kamimeguro, Meguro-ku, Tokyo, Japan 153-0051

Phone: 81-3-5773-3850

ON Semiconductor Website: <http://onsemi.com>

Order Literature: <http://www.onsemi.com/litorder>

For additional information, please contact your
 local Sales Representative.