

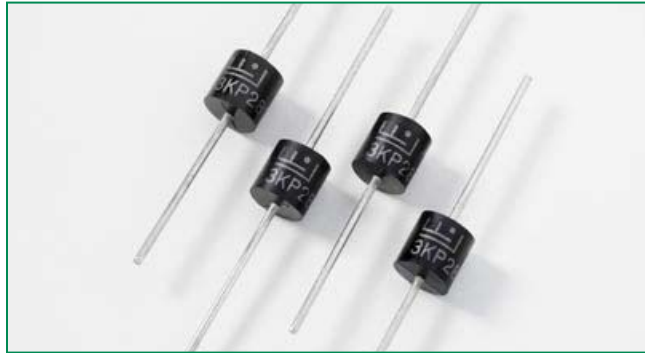

HF  **3KP Series**

Agency Approvals

| AGENCY | AGENCY FILE NUMBER |
|---|--------------------|
|  | E230531 |

Maximum Ratings and Thermal Characteristics
 (T_A=25°C unless otherwise noted)

| Parameter | Symbol | Value | Unit |
|---|-----------------------------------|------------|------|
| Peak Pulse Power Dissipation by 10x1000µs test waveform (Fig.1) (Note 1) | P _{PPM} | 3000 | W |
| Steady State Power Dissipation on infinite heat sink at T _L =75°C (Fig. 5) | P _D | 7.0 | W |
| Peak Forward Surge Current, 8.3ms Single Half Sine Wave Unidirectional only (Note 2) | I _{FSM} | 300 | A |
| Maximum Instantaneous Forward Voltage at 100A for Unidirectional only (Note 3) | V _F | 3.5/5.0 | V |
| Operating Junction and Storage Temperature Range | T _J , T _{STG} | -55 to 175 | °C |
| Typical Thermal Resistance Junction to Lead | R _{WJL} | 8.0 | °C/W |
| Typical Thermal Resistance Junction to Ambient | R _{WJA} | 40 | °C/W |

Notes:

1. Non-repetitive current pulse, per Fig. 3 and derated above T_A = 25°C per Fig. 2.
2. Measured on 8.3ms single half sine wave or equivalent square wave, duty cycle=4 per minute maximum.
3. V_F<3.5V for devices of V_{BR} ≤ 200V and V_F<5.0V for devices of V_{BR} ≥ 201V.

Description

The 3KP Series is designed specifically to protect sensitive electronic equipment from voltage transients induced by lightning and other transient voltage events.

Features

- Halogen-Free
- RoHS compliant
- Typical maximum temperature coefficient
 $\Delta V_{BR} = 0.1\% \times V_{BR} @ 25^\circ\text{C} \times \Delta T$
- Glass passivated chip junction in P600 package
- 3000W peak pulse capability at 10x1000µs waveform, repetition rate (duty cycles):0.01%
- Fast response time: typically less than 1.0ps from 0 Volts to BV min
- Excellent clamping capability
- Low incremental surge resistance
- Typical I_R less than 2µA above 12V
- High temperature soldering guaranteed: 260°C/40 seconds / 0.375" (9.5mm) lead length, 5 lbs., (2.3kg) tension
- Plastic package has Underwriters Laboratory Flammability classification 94V-O
- Matte Tin Lead-free plated

Applications

TVS devices are ideal for the protection of I/O interfaces, V_{CC} bus and other vulnerable circuits used in telecom, computer, industrial and consumer electronic applications.

Transient Voltage Suppression Diodes

Axial Leaded – 3000W > 3KP series

Electrical Characteristics

| Part Number (Uni) | Part Number (Bi) | Reverse Stand off Voltage V_R (Volts) | Breakdown Voltage V_{BR} (Volts) @ I_T | | Test Current I_T (mA) | Maximum Clamping Voltage V_C @ I_{PP} (V) | Maximum Peak Pulse Current I_{PP} (A) | Maximum Reverse Leakage I_R @ V_R (μ A) | Agency Approval  |
|-------------------|------------------|---|--|--------|-------------------------|---|---|--|---|
| | | | MIN | MAX | | | | | |
| 3KP5.0A | 3KP5.0CA | 5.0 | 6.40 | 7.00 | 50 | 9.2 | 326.1 | 5000 | X |
| 3KP6.0A | 3KP6.0CA | 6.0 | 6.67 | 7.37 | 50 | 10.3 | 291.3 | 5000 | X |
| 3KP6.5A | 3KP6.5CA | 6.5 | 7.22 | 7.98 | 50 | 11.2 | 267.9 | 2000 | X |
| 3KP7.0A | 3KP7.0CA | 7.0 | 7.78 | 8.60 | 50 | 12.0 | 250.0 | 1000 | X |
| 3KP7.5A | 3KP7.5CA | 7.5 | 8.33 | 9.21 | 5 | 12.9 | 232.6 | 250 | X |
| 3KP8.0A | 3KP8.0CA | 8.0 | 8.89 | 9.83 | 5 | 13.6 | 220.6 | 150 | X |
| 3KP8.5A | 3KP8.5CA | 8.5 | 9.44 | 10.40 | 5 | 14.4 | 208.3 | 50 | X |
| 3KP9.0A | 3KP9.0CA | 9.0 | 10.00 | 11.10 | 5 | 15.4 | 194.8 | 20 | X |
| 3KP10A | 3KP10CA | 10.0 | 11.10 | 12.30 | 5 | 17.0 | 176.5 | 15 | X |
| 3KP11A | 3KP11CA | 11.0 | 12.20 | 13.50 | 5 | 18.2 | 164.8 | 2 | X |
| 3KP12A | 3KP12CA | 12.0 | 13.30 | 14.70 | 5 | 19.9 | 150.8 | 2 | X |
| 3KP13A | 3KP13CA | 13.0 | 14.40 | 15.90 | 5 | 21.5 | 139.5 | 2 | X |
| 3KP14A | 3KP14CA | 14.0 | 15.60 | 17.20 | 5 | 23.2 | 129.3 | 2 | X |
| 3KP15A | 3KP15CA | 15.0 | 16.70 | 18.50 | 5 | 24.4 | 123.0 | 2 | X |
| 3KP16A | 3KP16CA | 16.0 | 17.80 | 19.70 | 5 | 26.0 | 115.4 | 2 | X |
| 3KP17A | 3KP17CA | 17.0 | 18.90 | 20.90 | 5 | 27.6 | 108.7 | 2 | X |
| 3KP18A | 3KP18CA | 18.0 | 20.00 | 22.10 | 5 | 29.2 | 102.7 | 2 | X |
| 3KP20A | 3KP20CA | 20.0 | 22.20 | 24.50 | 5 | 32.4 | 92.6 | 2 | X |
| 3KP22A | 3KP22CA | 22.0 | 24.40 | 26.90 | 5 | 35.5 | 84.5 | 2 | X |
| 3KP24A | 3KP24CA | 24.0 | 26.70 | 29.50 | 5 | 38.9 | 77.1 | 2 | X |
| 3KP26A | 3KP26CA | 26.0 | 28.90 | 31.90 | 5 | 42.1 | 71.3 | 2 | X |
| 3KP28A | 3KP28CA | 28.0 | 31.10 | 34.40 | 5 | 45.4 | 66.1 | 2 | X |
| 3KP30A | 3KP30CA | 30.0 | 33.30 | 36.80 | 5 | 48.4 | 62.0 | 2 | X |
| 3KP33A | 3KP33CA | 33.0 | 36.70 | 40.60 | 5 | 53.3 | 56.3 | 2 | X |
| 3KP36A | 3KP36CA | 36.0 | 40.00 | 44.20 | 5 | 58.1 | 51.6 | 2 | X |
| 3KP40A | 3KP40CA | 40.0 | 44.40 | 49.10 | 5 | 64.5 | 46.5 | 2 | X |
| 3KP43A | 3KP43CA | 43.0 | 47.80 | 52.80 | 5 | 69.4 | 43.2 | 2 | X |
| 3KP45A | 3KP45CA | 45.0 | 50.00 | 55.30 | 5 | 72.7 | 41.3 | 2 | X |
| 3KP48A | 3KP48CA | 48.0 | 53.30 | 58.90 | 5 | 77.4 | 38.8 | 2 | X |
| 3KP51A | 3KP51CA | 51.0 | 56.70 | 62.70 | 5 | 82.4 | 36.4 | 2 | X |
| 3KP54A | 3KP54CA | 54.0 | 60.00 | 66.30 | 5 | 87.1 | 34.4 | 2 | X |
| 3KP58A | 3KP58CA | 58.0 | 64.40 | 71.20 | 5 | 93.6 | 32.1 | 2 | X |
| 3KP60A | 3KP60CA | 60.0 | 66.70 | 73.70 | 5 | 96.8 | 31.0 | 2 | X |
| 3KP64A | 3KP64CA | 64.0 | 71.10 | 78.60 | 5 | 103.0 | 29.1 | 2 | X |
| 3KP70A | 3KP70CA | 70.0 | 77.80 | 86.00 | 5 | 113.0 | 26.5 | 2 | X |
| 3KP75A | 3KP75CA | 75.0 | 83.30 | 92.10 | 5 | 121.0 | 24.8 | 2 | X |
| 3KP78A | 3KP78CA | 78.0 | 86.70 | 95.80 | 5 | 126.0 | 23.8 | 2 | X |
| 3KP85A | 3KP85CA | 85.0 | 94.40 | 104.00 | 5 | 137.0 | 21.9 | 2 | X |
| 3KP90A | 3KP90CA | 90.0 | 100.00 | 111.00 | 5 | 146.0 | 20.5 | 2 | X |
| 3KP100A | 3KP100CA | 100.0 | 111.00 | 123.00 | 5 | 162.0 | 18.5 | 2 | X |
| 3KP110A | 3KP110CA | 110.0 | 122.00 | 135.00 | 5 | 177.0 | 16.9 | 2 | X |
| 3KP120A | 3KP120CA | 120.0 | 133.00 | 147.00 | 5 | 193.0 | 15.5 | 2 | X |
| 3KP130A | 3KP130CA | 130.0 | 144.00 | 159.00 | 5 | 209.0 | 14.4 | 2 | X |
| 3KP150A | 3KP150CA | 150.0 | 167.00 | 185.00 | 5 | 243.0 | 12.3 | 2 | X |
| 3KP160A | 3KP160CA | 160.0 | 178.00 | 197.00 | 5 | 259.0 | 11.6 | 2 | X |
| 3KP170A | 3KP170CA | 170.0 | 189.00 | 209.00 | 5 | 275.0 | 10.9 | 2 | X |
| 3KP180A | 3KP180CA | 180.0 | 200.00 | 221.00 | 5 | 289.0 | 10.4 | 2 | X |
| 3KP190A | 3KP190CA | 190.0 | 211.00 | 233.00 | 5 | 310.0 | 9.7 | 2 | X |
| 3KP200A | 3KP200CA | 200.0 | 222.00 | 246.00 | 5 | 329.2 | 9.1 | 2 | X |
| 3KP210A | 3KP210CA | 210.0 | 233.00 | 258.00 | 5 | 349.5 | 8.6 | 2 | X |
| 3KP220A | 3KP220CA | 220.0 | 244.00 | 270.00 | 5 | 371.1 | 8.1 | 2 | X |

For parts without A, the V_{BR} is $\pm 10\%$ and V_C is 5% higher than with A parts

For bidirectional type having V_R of 10 volts and less, the I_R limit is double.

Ratings and Characteristic Curves ($T_A=25^\circ\text{C}$ unless otherwise noted)

Figure 1 - Peak Pulse Power Rating Curve

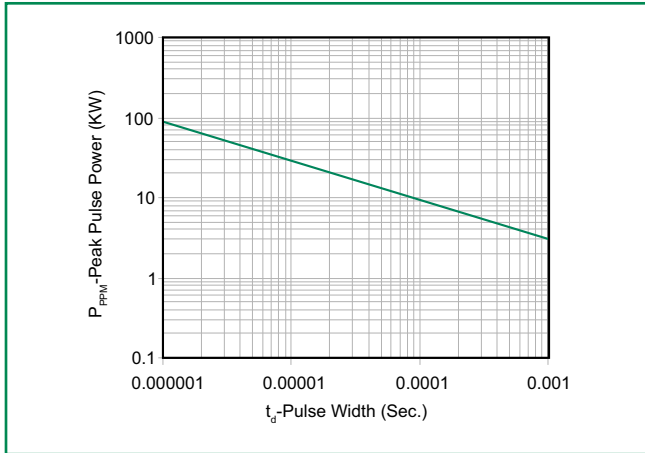

Figure 2 - Pulse Derating Curve

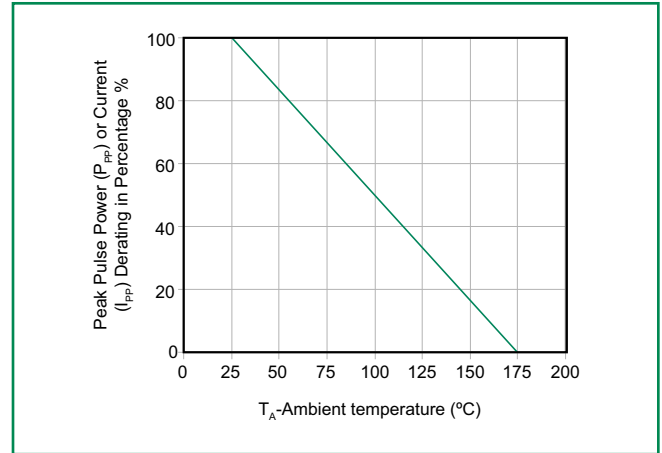

Figure 3 - Pulse Waveform



Figure 4 - Typical Junction Capacitance

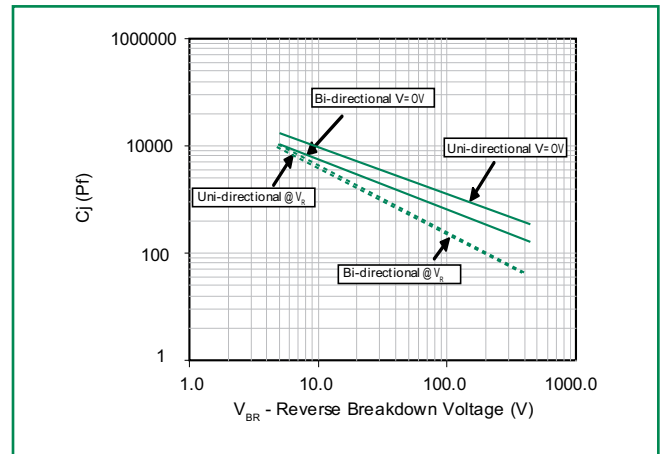

Figure 5 - Steady State Power Derating Curve

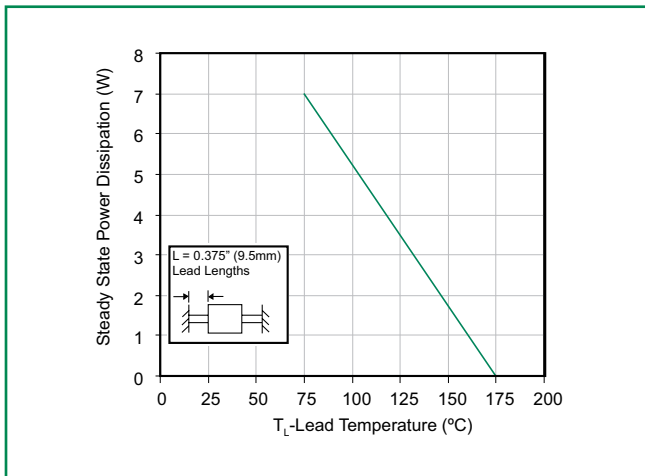
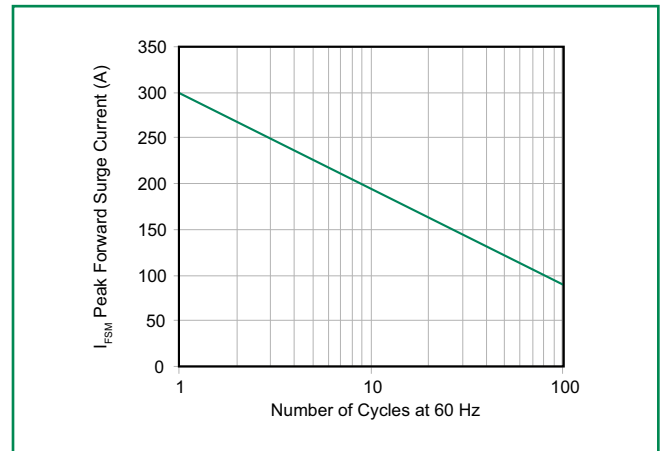
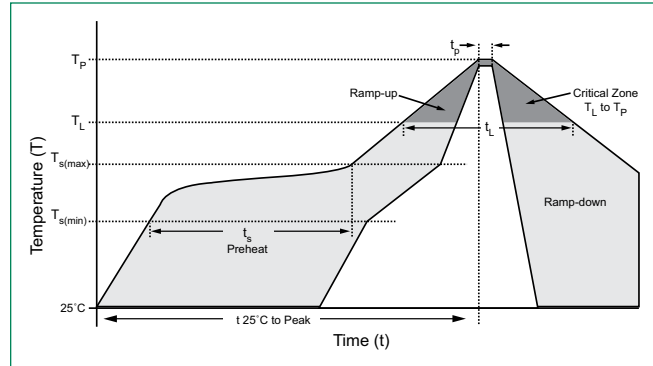

Figure 6 - Maximum Non-Repetitive Peak Forward Surge Current



Soldering Parameters

| | | |
|--|------------------------------------|-------------------------|
| Reflow Condition | | Lead-free assembly |
| Pre Heat | - Temperature Min ($T_{s(min)}$) | 150°C |
| | - Temperature Max ($T_{s(max)}$) | 200°C |
| | - Time (min to max) (t_s) | 60 – 180 secs |
| Average ramp up rate (Liquidus Temp (T_L) to peak) | | 3°C/second max |
| $T_{s(max)}$ to T_L - Ramp-up Rate | | 3°C/second max |
| Reflow | - Temperature (T_L) (Liquidus) | 217°C |
| | - Time (min to max) (t_s) | 60 – 150 seconds |
| Peak Temperature (T_p) | | 260 ^{+0/-5} °C |
| Time within 5°C of actual peak Temperature (t_p) | | 20 – 40 seconds |
| Ramp-down Rate | | 6°C/second max |
| Time 25°C to peak Temperature (T_p) | | 8 minutes Max. |
| Do not exceed | | 280°C |



Flow/Wave Soldering (Solder Dipping)

| | |
|---------------------------|------------|
| Peak Temperature : | 265°C |
| Dipping Time : | 10 seconds |
| Soldering : | 1 time |

Physical Specifications

| | |
|-----------------|---|
| Weight | 0.07oz., 2.1g |
| Case | P600 molded plastic body over passivated junction. |
| Polarity | Color band denotes the cathode except Bipolar. |
| Terminal | Matte Tin axial leads, solderable per JESD22-B102D. |

Environmental Specifications

| | |
|---------------------------|--------------|
| Temperature Cycle | JESD22-A104 |
| Pressure Cooker | JESD 22-A102 |
| High Temp. Storage | JESD22-A103 |
| HTRB | JESD22-A108 |
| Thermal Shock | JESD22-A106 |

Dimensions

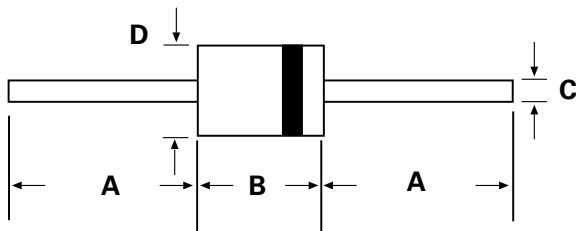

P600

| Dimensions | Inches | | Millimeters | |
|------------|--------|-------|-------------|------|
| | Min | Max | Min | Max |
| A | 1.000 | - | 25.40 | - |
| B | 0.340 | 0.360 | 8.60 | 9.10 |
| C | 0.048 | 0.052 | 1.22 | 1.32 |
| D | 0.340 | 0.360 | 8.60 | 9.10 |

Part Numbering System

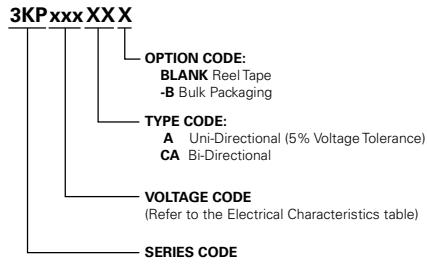

Part Marking System

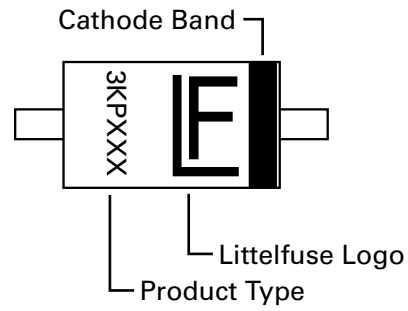

Packaging

| Part Number | Component Package | Quantity | Packaging Option | Packaging Specification |
|-------------|-------------------|----------|------------------|--|
| 3KPxxxXX | P600 | 800 | Tape & Reel | EIA STD RS-296E |
| 3KPxxxXX-B | P600 | 500 | BULK | Littelfuse Concord Packing Spec. DM-0016 |