

1.5SMC6.8AT3 Series

1500 Watt Peak Power Zener Transient Voltage Suppressors

Unidirectional*

The SMC series is designed to protect voltage sensitive components from high voltage, high energy transients. They have excellent clamping capability, high surge capability, low zener impedance and fast response time. The SMC series is supplied in ON Semiconductor's exclusive, cost-effective, highly reliable Surmetic™ package and is ideally suited for use in communication systems, automotive, numerical controls, process controls, medical equipment, business machines, power supplies and many other industrial/consumer applications.

Specification Features

- Working Peak Reverse Voltage Range – 5.8 to 77.8 V
- Standard Zener Breakdown Voltage Range – 6.8 to 91 V
- Peak Power – 1500 W @ 1.0 ms
- ESD Rating of Class 3 (>16 kV) per Human Body Model
- Maximum Clamp Voltage @ Peak Pulse Current
- Low Leakage < 5.0 μ A Above 10 V
- UL 497B for Isolated Loop Circuit Protection
- Maximum Temperature Coefficient Specified
- Response Time is Typically < 1.0 ns
- Pb-Free Packages are Available

Mechanical Characteristics

CASE: Void-free, transfer-molded, thermosetting plastic

FINISH: All external surfaces are corrosion resistant and leads are readily solderable

MAXIMUM CASE TEMPERATURE FOR SOLDERING PURPOSES:
260°C for 10 Seconds

LEADS: Modified L-Bend providing more contact area to bond pads

POLARITY: Cathode indicated by molded polarity notch

MOUNTING POSITION: Any



ON Semiconductor®

<http://onsemi.com>

**PLASTIC SURFACE MOUNT
ZENER OVERVOLTAGE
TRANSIENT SUPPRESSORS
5.8 – 78 VOLTS
1500 WATT PEAK POWER**

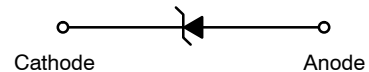

**SMC
CASE 403
PLASTIC**

MARKING DIAGRAM

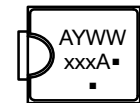

xxxA = Specific Device Code
(See Table on Page 3)

A = Assembly Location

Y = Year

WW = Work Week

▪ = Pb-Free Package

(Note: Microdot may be in either location)

ORDERING INFORMATION

Device*	Package	Shipping†
1.5SMCxxxAT3	SMC	2500/Tape & Reel
1.5SMCxxxAT3G	SMC (Pb-Free)	2500/Tape & Reel

Individual devices are listed on page 3 of this data sheet.

*The "T3" suffix refers to a 13 inch reel.

†For information on tape and reel specifications, including part orientation and tape sizes, please refer to our Tape and Reel Packaging Specifications Brochure, BRD8011/D.

**Bidirectional devices will not be available in this series.

1.5SMC6.8AT3 Series

MAXIMUM RATINGS

Rating	Symbol	Value	Unit
Peak Power Dissipation (Note 1) @ $T_L = 25^\circ\text{C}$, Pulse Width = 1 ms	P_{PK}	1500	W
DC Power Dissipation @ $T_L = 75^\circ\text{C}$ Measured Zero Lead Length (Note 2) Derate Above 75°C	P_D	4.0	W
Thermal Resistance, Junction-to-Lead	$R_{\theta JL}$	54.6 18.3	$\text{mW}/^\circ\text{C}$ $^\circ\text{C}/\text{W}$
DC Power Dissipation (Note 3) @ $T_A = 25^\circ\text{C}$ Derate Above 25°C	P_D	0.75	W
Thermal Resistance from Junction-to-Ambient	$R_{\theta JA}$	6.1 165	$\text{mW}/^\circ\text{C}$ $^\circ\text{C}/\text{W}$
Forward Surge Current (Note 4) @ $T_A = 25^\circ\text{C}$	I_{FSM}	200	A
Operating and Storage Temperature Range	T_J, T_{stg}	-65 to +150	$^\circ\text{C}$

Stresses exceeding Maximum Ratings may damage the device. Maximum Ratings are stress ratings only. Functional operation above the Recommended Operating Conditions is not implied. Extended exposure to stresses above the Recommended Operating Conditions may affect device reliability.

- 10 X 1000 μs , non-repetitive
- 1 in. square copper pad, FR-4 board
- FR-4 board, using ON Semiconductor minimum recommended footprint, as shown in 403 case outline dimensions spec.
- 1/2 sine wave (or equivalent square wave), PW = 8.3 ms, duty cycle = 4 pulses per minute maximum.

ELECTRICAL CHARACTERISTICS ($T_A = 25^\circ\text{C}$ unless otherwise noted, $V_F = 3.5\text{ V Max.}$ @ I_F (Note 5) = 100 A)

Symbol	Parameter
I_{PP}	Maximum Reverse Peak Pulse Current
V_C	Clamping Voltage @ I_{PP}
V_{RWM}	Working Peak Reverse Voltage
I_R	Maximum Reverse Leakage Current @ V_{RWM}
V_{BR}	Breakdown Voltage @ I_T
I_T	Test Current
ΘV_{BR}	Maximum Temperature Coefficient of V_{BR}
I_F	Forward Current
V_F	Forward Voltage @ I_F

- 1/2 sine wave or equivalent, PW = 8.3 ms non-repetitive duty cycle

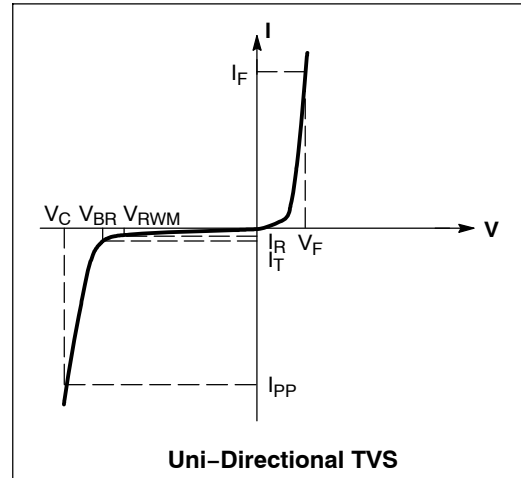

1.5SMC6.8AT3 Series

ELECTRICAL CHARACTERISTICS (Devices listed in **bold, italic** are ON Semiconductor Preferred devices.)

Device*	Device Marking	V _{RWM} (Note 6)	I _R @ V _{RWM}	Breakdown Voltage				V _C @ I _{PP} (Note 8)		θV _{BR} %/°C
				V _{BR} V (Note 7)			@ I _T	V _C	I _{PP}	
				Min	Nom	Max	mA	V	A	
1.5SMC6.8AT3, G	6V8A	5.8	1000	6.45	6.8	7.14	10	10.5	143	0.057
1.5SMC7.5AT3, G	7V5A	6.4	500	7.13	7.5	7.88	10	11.3	132	0.061
1.5SMC8.2AT3, G	8V2A	7.02	200	7.79	8.2	8.61	10	12.1	124	0.065
1.5SMC9.1AT3	9V1A	7.78	50	8.65	9.1	9.55	1	13.4	112	0.068
1.5SMC10AT3	10A	8.55	10	9.5	10	10.5	1	14.5	103	0.073
1.5SMC11AT3	11A	9.4	5	10.5	11	11.6	1	15.6	96	0.075
1.5SMC12AT3, G	12A	10.2	5	11.4	12	12.6	1	16.7	90	0.078
1.5SMC13AT3, G	13A	11.1	5	12.4	13	13.7	1	18.2	82	0.081
1.5SMC15AT3, G	15A	12.8	5	14.3	15	15.8	1	21.2	71	0.084
1.5SMC16AT3, G	16A	13.6	5	15.2	16	16.8	1	22.5	67	0.086
1.5SMC18AT3, G	18A	15.3	5	17.1	18	18.9	1	25.2	59.5	0.088
1.5SMC20AT3, G	20A	17.1	5	19	20	21	1	27.7	54	0.09
1.5SMC22AT3, G	22A	18.8	5	20.9	22	23.1	1	30.6	49	0.092
1.5SMC24AT3, G	24A	20.5	5	22.8	24	25.2	1	33.2	45	0.094
1.5SMC27AT3, G	27A	23.1	5	25.7	27	28.4	1	37.5	40	0.096
1.5SMC30AT3, G	30A	25.6	5	28.5	30	31.5	1	41.4	36	0.097
1.5SMC33AT3, G	33A	28.2	5	31.4	33	34.7	1	45.7	33	0.098
1.5SMC36AT3, G	36A	30.8	5	34.2	36	37.8	1	49.9	30	0.099
1.5SMC39AT3, G	39A	33.3	5	37.1	39	41	1	53.9	28	0.1
1.5SMC43AT3, G	43A	36.8	5	40.9	43	45.2	1	59.3	25.3	0.101
1.5SMC47AT3, G	47A	40.2	5	44.7	47	49.4	1	64.8	23.2	0.101
1.5SMC51AT3, G	51A	43.6	5	48.5	51	53.6	1	70.1	21.4	0.102
1.5SMC56AT3, G	56A	47.8	5	53.2	56	58.8	1	77	19.5	0.103
1.5SMC62AT3, G	62A	53	5	58.9	62	65.1	1	85	17.7	0.104
1.5SMC68AT3, G	68A	58.1	5	64.6	68	71.4	1	92	16.3	0.104
1.5SMC75AT3, G	75A	64.1	5	71.3	75	78.8	1	103	14.6	0.105
1.5SMC82AT3, G	82A	70.1	5	77.9	82	86.1	1	113	13.3	0.105
1.5SMC91AT3, G	91A	77.8	5	86.5	91	95.5	1	125	12	0.106

Devices listed in **bold, italic** are ON Semiconductor Preferred devices. Preferred devices are recommended choices for future use and best overall value.

6. A transient suppressor is normally selected according to the working peak reverse voltage (V_{RWM}), which should be equal to or greater than the DC or continuous peak operating voltage level.

7. V_{BR} measured at pulse test current I_T at an ambient temperature of 25°C.

8. Surge current waveform per Figure 2 and derate per Figure 3 of the General Data – 1500 Watt at the beginning of this group.

*The "G" suffix indicates Pb-Free package available.

1.5SMC6.8AT3 Series

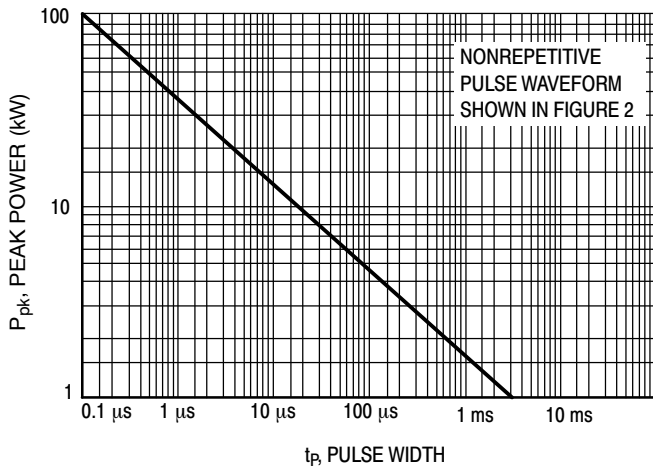

Figure 1. Pulse Rating Curve

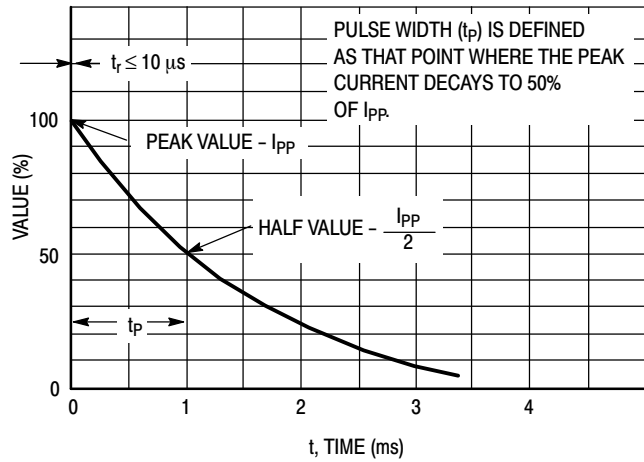

Figure 2. Pulse Waveform

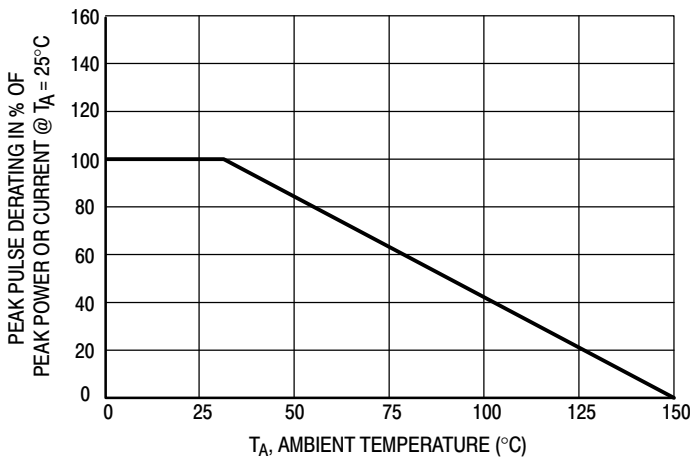

Figure 3. Pulse Derating Curve

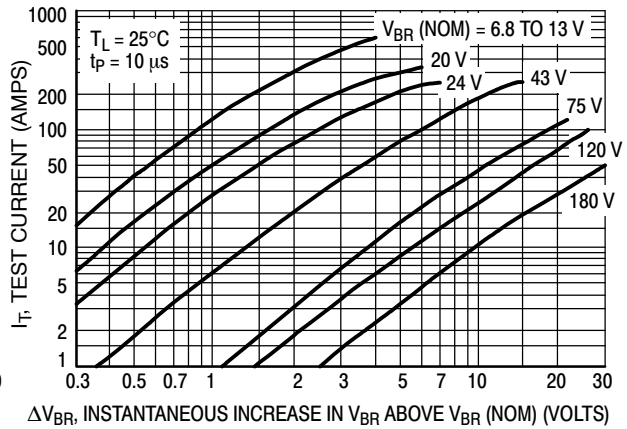

Figure 4. Dynamic Impedance

UL RECOGNITION

The entire series has *Underwriters Laboratory Recognition* for the classification of protectors (QVGQ2) under the UL standard for safety 497B and File #E210057. Many competitors only have one or two devices recognized or have recognition in a non-protective category. Some competitors have no recognition at all. With the UL497B recognition, our parts successfully passed several tests

including Strike Voltage Breakdown test, Endurance Conditioning, Temperature test, Dielectric Voltage-Withstand test, Discharge test and several more.

Whereas, some competitors have only passed a flammability test for the package material, we have been recognized for much more to be included in their Protector category.

1.5SMC6.8AT3 Series

APPLICATION NOTES

RESPONSE TIME

In most applications, the transient suppressor device is placed in parallel with the equipment or component to be protected. In this situation, there is a time delay associated with the capacitance of the device and an overshoot condition associated with the inductance of the device and the inductance of the connection method. The capacitive effect is of minor importance in the parallel protection scheme because it only produces a time delay in the transition from the operating voltage to the clamp voltage as shown in Figure 5.

The inductive effects in the device are due to actual turn-on time (time required for the device to go from zero current to full current) and lead inductance. This inductive effect produces an overshoot in the voltage across the equipment or component being protected as shown in Figure 6. Minimizing this overshoot is very important in the application, since the main purpose for adding a transient suppressor is to clamp voltage spikes. The SMC series have a very good response time, typically < 1.0 ns and negligible inductance. However, external inductive effects could produce unacceptable overshoot. Proper circuit layout,

minimum lead lengths and placing the suppressor device as close as possible to the equipment or components to be protected will minimize this overshoot.

Some input impedance represented by Z_{in} is essential to prevent overstress of the protection device. This impedance should be as high as possible, without restricting the circuit operation.

DUTY CYCLE DERATING

The data of Figure 1 applies for non-repetitive conditions and at a lead temperature of 25°C. If the duty cycle increases, the peak power must be reduced as indicated by the curves of Figure 7. Average power must be derated as the lead or ambient temperature rises above 25°C. The average power derating curve normally given on data sheets may be normalized and used for this purpose.

At first glance the derating curves of Figure 7 appear to be in error as the 10 ms pulse has a higher derating factor than the 10 μ s pulse. However, when the derating factor for a given pulse of Figure 7 is multiplied by the peak power value of Figure 1 for the same pulse, the results follow the expected trend.

1.5SMC6.8AT3 Series

TYPICAL PROTECTION CIRCUIT

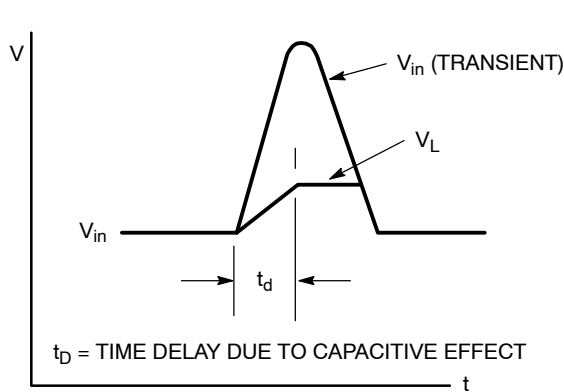
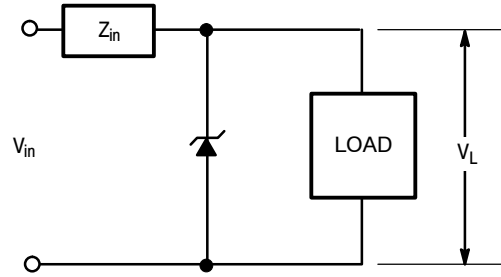

Figure 5.

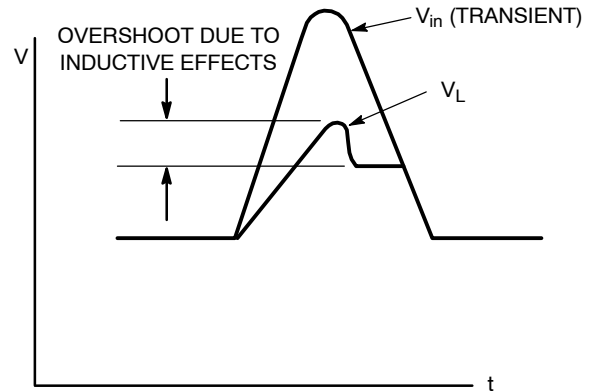

Figure 6.

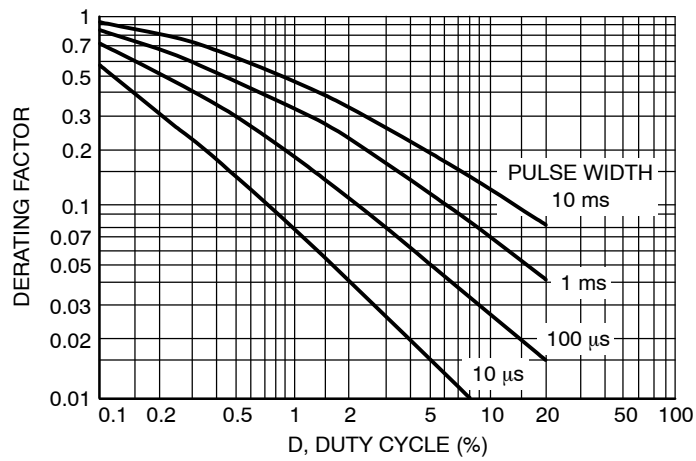
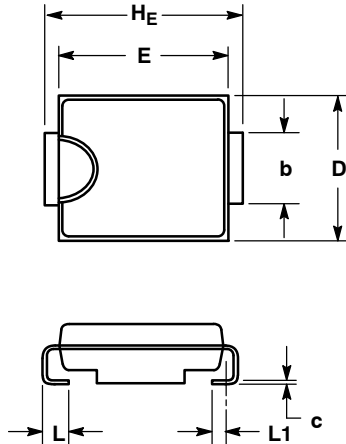

Figure 7. Typical Derating Factor for Duty Cycle

1.5SMC6.8AT3 Series

PACKAGE DIMENSIONS

SMC
CASE 403-03
ISSUE E



NOTES:

1. DIMENSIONING AND TOLERANCING PER ANSI Y14.5M, 1982.
2. CONTROLLING DIMENSION: INCH.
3. D DIMENSION SHALL BE MEASURED WITHIN DIMENSION P.
4. 403-01 THRU -02 OBSOLETE, NEW STANDARD 403-03.

DIM	MILLIMETERS			INCHES		
	MIN	NOM	MAX	MIN	NOM	MAX
A	1.90	2.13	2.41	0.075	0.084	0.095
A1	0.05	0.10	0.15	0.002	0.004	0.006
b	2.92	3.00	3.07	0.115	0.118	0.121
c	0.15	0.23	0.30	0.006	0.009	0.012
D	5.59	5.84	6.10	0.220	0.230	0.240
E	6.60	6.86	7.11	0.260	0.270	0.280
HE	7.75	7.94	8.13	0.305	0.313	0.320
L	0.76	1.02	1.27	0.030	0.040	0.050
L1	0.51 REF			0.020 REF		

SOLDERING FOOTPRINT*

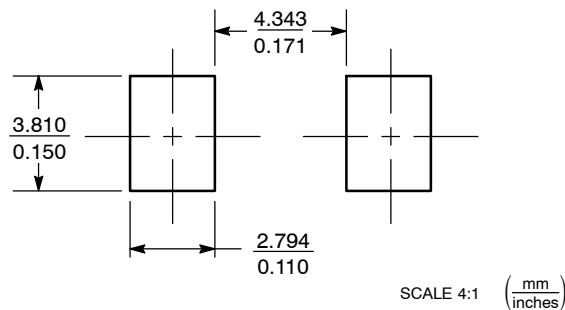

*For additional information on our Pb-Free strategy and soldering details, please download the ON Semiconductor Soldering and Mounting Techniques Reference Manual, SOLDERRM/D.

Surmetic is a trademark of Semiconductor Components Industries, LLC.

ON Semiconductor and are registered trademarks of Semiconductor Components Industries, LLC (SCILLC). SCILLC reserves the right to make changes without further notice to any products herein. SCILLC makes no warranty, representation or guarantee regarding the suitability of its products for any particular purpose, nor does SCILLC assume any liability arising out of the application or use of any product or circuit, and specifically disclaims any and all liability, including without limitation special, consequential or incidental damages. "Typical" parameters which may be provided in SCILLC data sheets and/or specifications can and do vary in different applications and actual performance may vary over time. All operating parameters, including "Typicals" must be validated for each customer application by customer's technical experts. SCILLC does not convey any license under its patent rights nor the rights of others. SCILLC products are not designed, intended, or authorized for use as components in systems intended for surgical implant into the body, or other applications intended to support or sustain life, or for any other application in which the failure of the SCILLC product could create a situation where personal injury or death may occur. Should Buyer purchase or use SCILLC products for any such unintended or unauthorized application, Buyer shall indemnify and hold SCILLC and its officers, employees, subsidiaries, affiliates, and distributors harmless against all claims, costs, damages, and expenses, and reasonable attorney fees arising out of, directly or indirectly, any claim of personal injury or death associated with such unintended or unauthorized use, even if such claim alleges that SCILLC was negligent regarding the design or manufacture of the part. SCILLC is an Equal Opportunity/Affirmative Action Employer. This literature is subject to all applicable copyright laws and is not for resale in any manner.

PUBLICATION ORDERING INFORMATION

LITERATURE FULFILLMENT:
Literature Distribution Center for ON Semiconductor
P.O. Box 5163, Denver, Colorado 80217 USA
Phone: 303-675-2175 or 800-344-3860 Toll Free USA/Canada
Fax: 303-675-2176 or 800-344-3867 Toll Free USA/Canada
Email: orderlit@onsemi.com

N. American Technical Support: 800-282-9855 Toll Free
USA/Canada
Europe, Middle East and Africa Technical Support:
Phone: 421 33 790 2910
Japan Customer Focus Center
Phone: 81-3-5773-3850

ON Semiconductor Website: www.onsemi.com
Order Literature: <http://www.onsemi.com/orderlit>
For additional information, please contact your local Sales Representative

1.5SMC6.8AT3/D