

# 1PMT5.0AT1/T3 Series

## Zener Transient Voltage Suppressor POWERMITE® Package

The 1PMT5.0AT1/T3 Series is designed to protect voltage sensitive components from high voltage, high energy transients. Excellent clamping capability, high surge capability, low Zener impedance and fast response time. The advanced packaging technique provides for a highly efficient micro miniature, space saving surface mount with its unique heatsink design. The POWERMITE has the same thermal performance as the SMA while being 50% smaller in footprint area, and delivering one of the lowest height profiles (1.1 mm) in the industry. Because of its small size, it is ideal for use in cellular phones, portable devices, business machines, power supplies and many other industrial/consumer applications.

### Specification Features:

- Stand-off Voltage: 5.0 V – 58 V
- Peak Power – 200 W @ 1 ms (1PMT5.0A – 1PMT36A)  
– 175 W @ 1 ms (1PMT40A – 1PMT58A)
- Maximum Clamp Voltage @ Peak Pulse Current
- Low Leakage
- Response Time is Typically < 1 ns
- ESD Rating of Class 3 (> 16 kV) per Human Body Model
- Low Profile – Maximum Height of 1.1 mm
- Integral Heatsink/Locking Tabs
- Full Metallic Bottom Eliminates Flux Entrapment
- Small Footprint – Footprint Area of 8.45 mm<sup>2</sup>
- POWERMITE is JEDEC Registered as DO-216AA
- Lead Orientation in Tape: Cathode (Short) Lead to Sprocket Holes
- Cathode Indicated by Polarity Band
- Pb-Free Packages are Available

### Mechanical Characteristics:

**CASE:** Void-free, transfer-molded, thermosetting plastic

**FINISH:** All external surfaces are corrosion resistant and leads are readily solderable

**MOUNTING POSITION:** Any

**MAXIMUM CASE TEMPERATURE FOR SOLDERING PURPOSES:**  
260°C for 10 Seconds



ON Semiconductor®

<http://onsemi.com>

### PLASTIC SURFACE MOUNT ZENER OVERVOLTAGE TRANSIENT SUPPRESSOR 5 – 58 V 200 W PEAK POWER



1: CATHODE  
2: ANODE

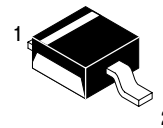

POWERMITE  
CASE 457  
PLASTIC

### MARKING DIAGRAM

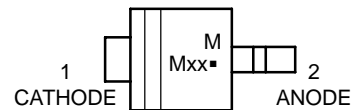

M = Date Code  
Mxx = Specific Device Code  
(See Table on Page 3)  
▪ = Pb-Free Package

### ORDERING INFORMATION

| Device     | Package                | Shipping†          |
|------------|------------------------|--------------------|
| 1PMTxxAT1  | POWERMITE              | 3,000/Tape & Reel  |
| 1PMTxxAT1G | POWERMITE<br>(Pb-Free) | 3,000/Tape & Reel  |
| 1PMTxxAT3  | POWERMITE              | 12,000/Tape & Reel |
| 1PMTxxAT3G | POWERMITE<br>(Pb-Free) | 12,000/Tape & Reel |

†For information on tape and reel specifications, including part orientation and tape sizes, please refer to our Tape and Reel Packaging Specifications Brochure, BRD8011/D.

# 1PMT5.0AT1/T3 Series

## MAXIMUM RATINGS

| Rating  | Symbol                                | Value       | Unit                           |
|---|---------------------------------------|-------------|--------------------------------|
| Maximum $P_{pk}$ Dissipation, (PW-10/1000 $\mu$ s) (Note 1) (1PMT5.0A – 1PMT36A)            | $P_{pk}$                              | 200         | W                              |
| Maximum $P_{pk}$ Dissipation, (PW-10/1000 $\mu$ s) (Note 1) (1PMT40A – 1PMT58A)             | $P_{pk}$                              | 175         | W                              |
| Maximum $P_{pk}$ Dissipation, (PW-8/20 $\mu$ s) (Note 1)                                    | $P_{pk}$                              | 1000        | W                              |
| DC Power Dissipation @ $T_A = 25^\circ\text{C}$ (Note 2)<br>Derate above $25^\circ\text{C}$ | $P_D$                                 | 500         | mW                             |
| Thermal Resistance, Junction-to-Ambient   | $R_{\theta JA}$                       | 4.0         | $\text{mW}/^\circ\text{C}$     |
| Thermal Resistance, Junction-to-Lead (Anode)  | $R_{\theta J\text{anode}}$            | 248         | $^\circ\text{C}/\text{W}$      |
| Maximum DC Power Dissipation (Note 3)<br>Thermal Resistance, Junction-to-Tab (Cathode)      | $P_D$<br>$R_{\theta J\text{cathode}}$ | 3.2<br>23   | W<br>$^\circ\text{C}/\text{W}$ |
| Operating and Storage Temperature Range   | $T_J, T_{stg}$                        | -55 to +150 | $^\circ\text{C}$               |

Maximum ratings are those values beyond which device damage can occur. Maximum ratings applied to the device are individual stress limit values (not normal operating conditions) and are not valid simultaneously. If these limits are exceeded, device functional operation is not implied, damage may occur and reliability may be affected.

1. Nonrepetitive current pulse at  $T_A = 25^\circ\text{C}$ .
2. Mounted with recommended minimum pad size, DC board FR-4.
3. At Tab (Cathode) temperature,  $T_{\text{tab}} = 75^\circ\text{C}$

## ELECTRICAL CHARACTERISTICS ( $T_A = 25^\circ\text{C}$ unless otherwise noted, $V_F = 3.5\text{ V Max. @ } I_F$ (Note 4) = 35 A)

| Symbol    | Parameter                                   |
|-----------|---|
| $I_{PP}$  | Maximum Reverse Peak Pulse Current          |
| $V_C$     | Clamping Voltage @ $I_{PP}$                 |
| $V_{RWM}$ | Working Peak Reverse Voltage                |
| $I_R$     | Maximum Reverse Leakage Current @ $V_{RWM}$ |
| $V_{BR}$  | Breakdown Voltage @ $I_T$                   |
| $I_T$     | Test Current                                |
| $I_F$     | Forward Current                             |
| $V_F$     | Forward Voltage @ $I_F$                     |

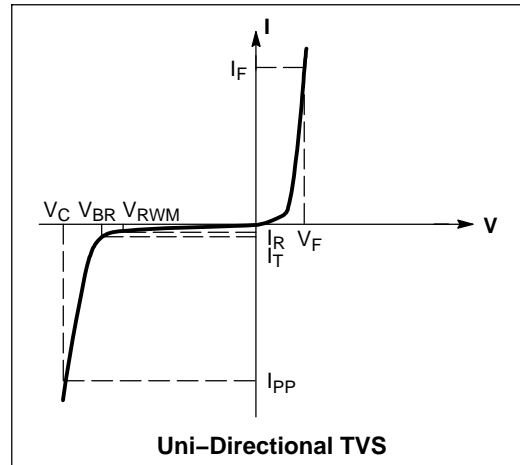

# 1PMT5.0AT1/T3 Series

**ELECTRICAL CHARACTERISTICS** ( $T_L = 30^\circ\text{C}$  unless otherwise noted,  $V_F = 1.25$  Volts @ 200 mA)

| Device*           | Marking | $V_{RWM}$ | $V_{BR} @ I_T$ (V) (Note 6) |       |      | $I_T$ | $I_R @ V_{RWM}$   | $V_C @ I_{PP}$ | $I_{PP}$ (A) |
|-------------------|---------|-----------|-----------------------------|-------|------|-------|-------------------|----------------|--------------|
|                   |         | (Note 5)  | Min                         | Nom   | Max  | (mA)  | ( $\mu\text{A}$ ) | (V)            | (Note 7)     |
| 1PMT5.0AT1, T3, G | MKE     | 5.0       | 6.4                         | 6.7   | 7.0  | 10    | 50                | 9.2            | 21.7         |
| 1PMT7.0AT1, T3, G | MKM     | 7.0       | 7.78                        | 8.2   | 8.6  | 10    | 30                | 12             | 16.7         |
| 1PMT12AT1, T3, G  | MLE     | 12        | 13.3                        | 14.0  | 14.7 | 1.0   | 1.0               | 19.9           | 10.1         |
| 1PMT16AT1, T3, G  | MLP     | 16        | 17.8                        | 18.75 | 19.7 | 1.0   | 1.0               | 26             | 7.7          |
| 1PMT18AT1, T3     | MLT     | 18        | 20.0                        | 21.0  | 22.1 | 1.0   | 1.0               | 29.2           | 6.8          |
| 1PMT22AT1, T3     | MLX     | 22        | 24.4                        | 25.6  | 26.9 | 1.0   | 1.0               | 35.5           | 5.6          |
| 1PMT24AT1, T3     | MLZ     | 24        | 26.7                        | 28.1  | 29.5 | 1.0   | 1.0               | 38.9           | 5.1          |
| 1PMT26AT1, T3     | MME     | 26        | 28.9                        | 30.4  | 31.9 | 1.0   | 1.0               | 42.1           | 4.8          |
| 1PMT28AT1, T3, G  | MMG     | 28        | 31.1                        | 32.8  | 34.4 | 1.0   | 1.0               | 45.4           | 4.4          |
| 1PMT30AT1, T3, G  | MMK     | 30        | 33.3                        | 35.1  | 36.8 | 1.0   | 1.0               | 48.4           | 4.1          |
| 1PMT33AT1, T3, G  | MMM     | 33        | 36.7                        | 38.7  | 40.6 | 1.0   | 1.0               | 53.3           | 3.8          |
| 1PMT36AT1, T3     | MMP     | 36        | 40.0                        | 42.1  | 44.2 | 1.0   | 1.0               | 58.1           | 3.4          |
| 1PMT40AT1, T3     | MMR     | 40        | 44.4                        | 46.8  | 49.1 | 1.0   | 1.0               | 64.5           | 2.7          |
| 1PMT48AT1, T3     | MMX     | 48        | 53.3                        | 56.1  | 58.9 | 1.0   | 1.0               | 77.4           | 2.3          |
| 1PMT51AT1, T3     | MMZ     | 51        | 56.7                        | 59.7  | 62.7 | 1.0   | 1.0               | 82.4           | 2.1          |
| 1PMT58AT1, T3     | MNG     | 58        | 64.4                        | 67.8  | 71.2 | 1.0   | 1.0               | 93.6           | 1.9          |

4. 1/2 sine wave (or equivalent square wave), PW = 8.3 ms, duty cycle = 4 pulses per minute maximum.

5. A transient suppressor is normally selected according to the Working Peak Reverse Voltage ( $V_{RWM}$ ) which should be equal to or greater than the DC or continuous peak operating voltage level.

6.  $V_{BR}$  measured at pulse test current  $I_T$  at ambient temperature of  $25^\circ\text{C}$ .

7. Surge current waveform per Figure 2 and derate per Figure 4.

\*The "G" suffix indicates Pb-Free package available.

# 1PMT5.0AT1/T3 Series

## TYPICAL PROTECTION CIRCUIT

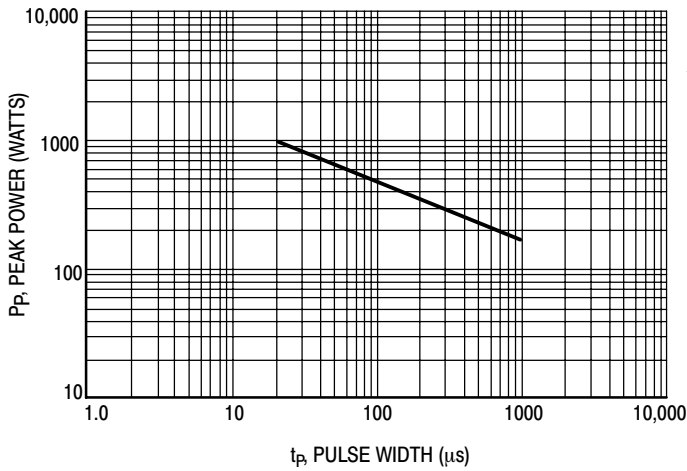
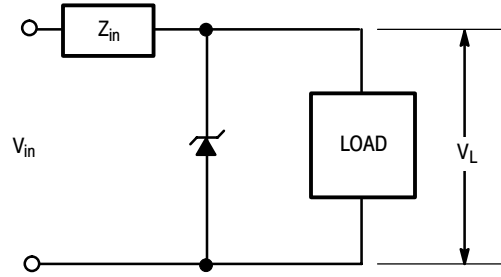

Figure 1. Pulse Rating Curve

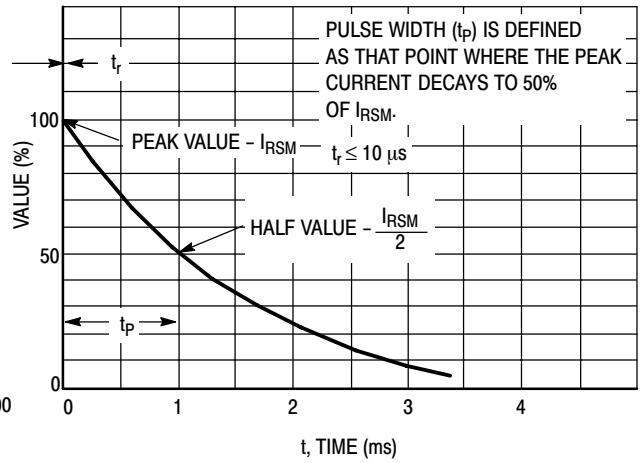

Figure 2. 10 X 1000  $\mu$ s Pulse Waveform

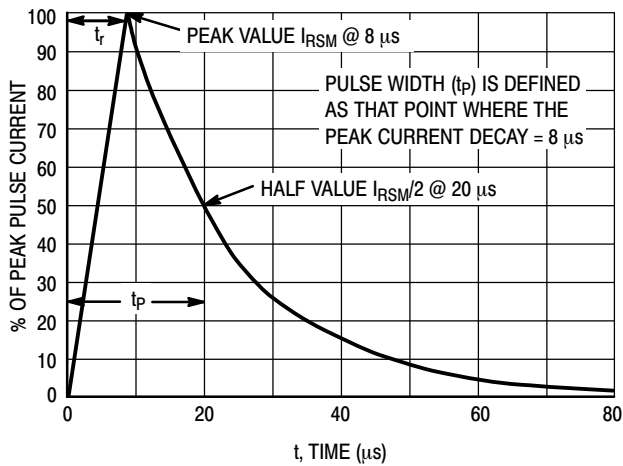

Figure 3. 8 X 20  $\mu$ s Pulse Waveform

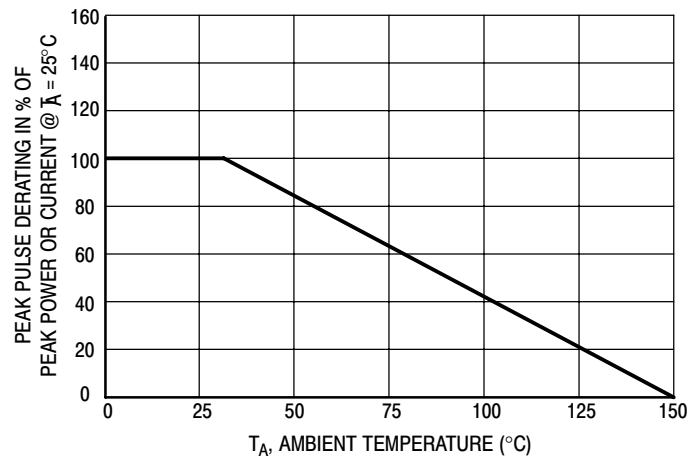

Figure 4. Pulse Derating Curve

# 1PMT5.0AT1/T3 Series

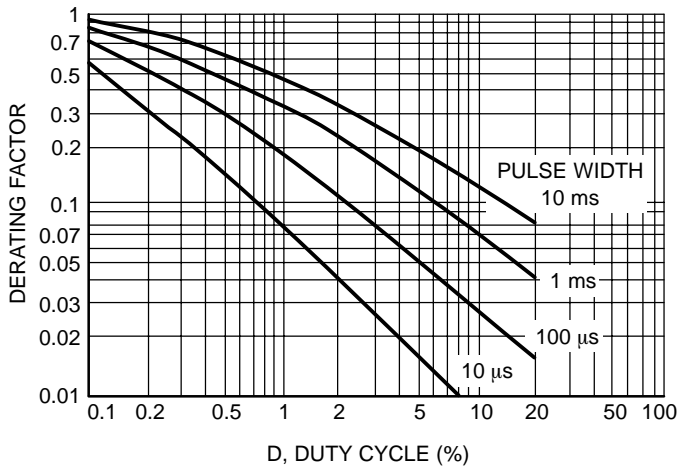

Figure 5. Typical Derating Factor for Duty Cycle

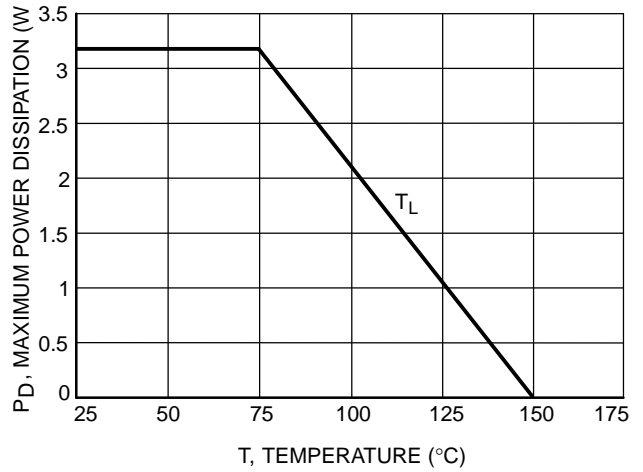

Figure 6. Steady State Power Derating

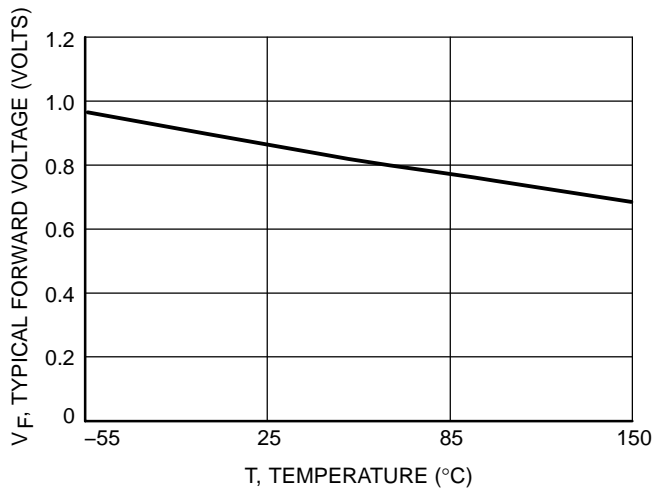

Figure 7. Forward Voltage

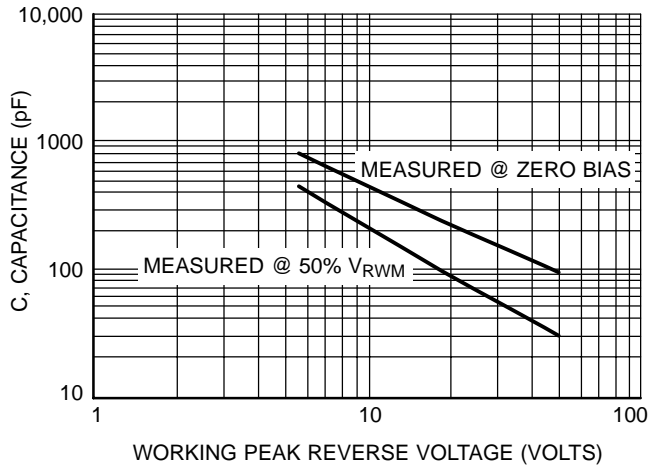
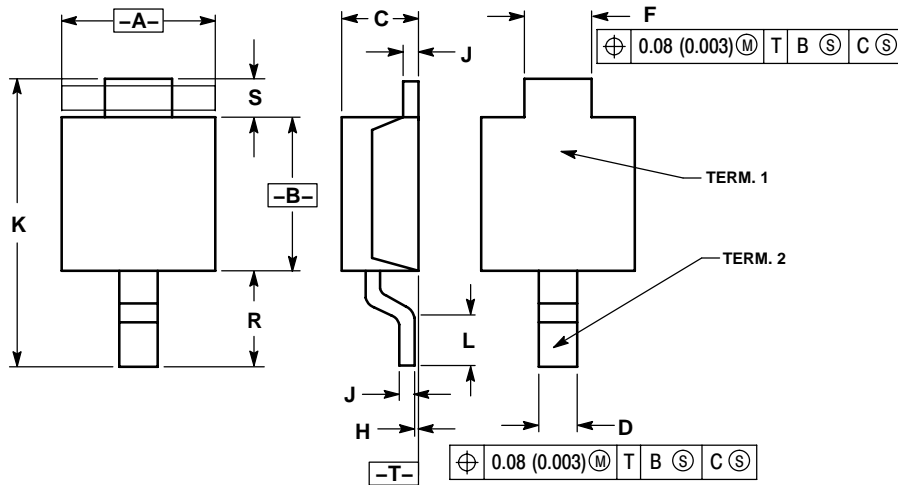

Figure 8. Capacitance versus Working Peak Reverse Voltage

# 1PMT5.0AT1/T3 Series

## OUTLINE DIMENSIONS

POWERMITE  
CASE 457-04  
ISSUE D



### NOTES:

1. DIMENSIONING AND TOLERANCING PER ANSI Y14.5M, 1982.
2. CONTROLLING DIMENSION: MILLIMETER.
3. DIMENSION A DOES NOT INCLUDE MOLD FLASH, PROTRUSIONS OR GATE BURRS. MOLD FLASH, PROTRUSIONS OR GATE BURRS SHALL NOT EXCEED 0.15 (0.006) PER SIDE.

| DIM | MILLIMETERS |       | INCHES    |        |
|-----|-------------|-------|-----------|--------|
|     | MIN         | MAX   | MIN       | MAX    |
| A   | 1.75        | 2.05  | 0.069     | 0.081  |
| B   | 1.75        | 2.18  | 0.069     | 0.086  |
| C   | 0.85        | 1.15  | 0.033     | 0.045  |
| D   | 0.40        | 0.69  | 0.016     | 0.027  |
| F   | 0.70        | 1.00  | 0.028     | 0.039  |
| H   | -0.05       | +0.10 | -0.002    | +0.004 |
| J   | 0.10        | 0.25  | 0.004     | 0.010  |
| K   | 3.60        | 3.90  | 0.142     | 0.154  |
| L   | 0.50        | 0.80  | 0.020     | 0.031  |
| R   | 1.20        | 1.50  | 0.047     | 0.059  |
| S   | 0.50 REF    |       | 0.019 REF |        |

### SOLDERING FOOTPRINT\*

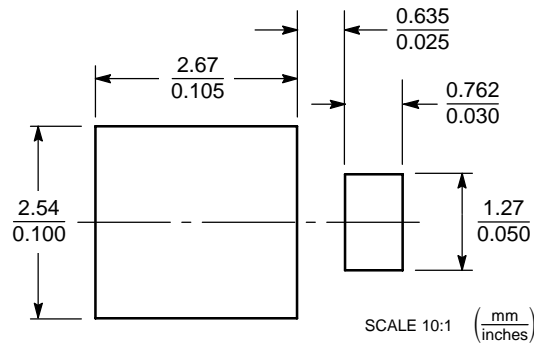

\*For additional information on our Pb-Free strategy and soldering details, please download the ON Semiconductor Soldering and Mounting Techniques Reference Manual, SOLDERRM/D.

POWERMITE is a registered trademark of and used under a license from Microsemi Corporation.

ON Semiconductor and are registered trademarks of Semiconductor Components Industries, LLC (SCILLC). SCILLC reserves the right to make changes without further notice to any products herein. SCILLC makes no warranty, representation or guarantee regarding the suitability of its products for any particular purpose, nor does SCILLC assume any liability arising out of the application or use of any product or circuit, and specifically disclaims any and all liability, including without limitation special, consequential or incidental damages. "Typical" parameters which may be provided in SCILLC data sheets and/or specifications can and do vary in different applications and actual performance may vary over time. All operating parameters, including "Typicals" must be validated for each customer application by customer's technical experts. SCILLC does not convey any license under its patent rights nor the rights of others. SCILLC products are not designed, intended, or authorized for use as components in systems intended for surgical implant into the body, or other applications intended to support or sustain life, or for any other application in which the failure of the SCILLC product could create a situation where personal injury or death may occur. Should Buyer purchase or use SCILLC products for any such unintended or unauthorized application, Buyer shall indemnify and hold SCILLC and its officers, employees, subsidiaries, affiliates, and distributors harmless against all claims, costs, damages, and expenses, and reasonable attorney fees arising out of, directly or indirectly, any claim of personal injury or death associated with such unintended or unauthorized use, even if such claim alleges that SCILLC was negligent regarding the design or manufacture of the part. SCILLC is an Equal Opportunity/Affirmative Action Employer. This literature is subject to all applicable copyright laws and is not for resale in any manner.

### PUBLICATION ORDERING INFORMATION

**LITERATURE FULFILLMENT:**  
Literature Distribution Center for ON Semiconductor  
P.O. Box 61312, Phoenix, Arizona 85082-1312 USA  
**Phone:** 480-829-7710 or 800-344-3860 Toll Free USA/Canada  
**Fax:** 480-829-7709 or 800-344-3867 Toll Free USA/Canada  
**Email:** orderlit@onsemi.com

**N. American Technical Support:** 800-282-9855 Toll Free  
USA/Canada

**Japan:** ON Semiconductor, Japan Customer Focus Center  
2-9-1 Kamimeguro, Meguro-ku, Tokyo, Japan 153-0051  
**Phone:** 81-3-5773-3850

**ON Semiconductor Website:** <http://onsemi.com>

**Order Literature:** <http://www.onsemi.com/litorder>

For additional information, please contact your local Sales Representative.

1PMT5.0AT3/D