

## CPDV6-5V0U

### RoHS Device

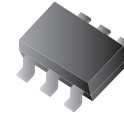

### Features

- IEC61000-4-2 8kV(Contact), 15kV(air).
- Surface mount package.
- High component density.

### Mechanical data

- Case: SOT-363 Standard package, molded plastic.
- Terminals: Gold plated, solderable per MIL-STD-750D, method 2026.
- Mounting position: Any.
- Weight: 0.0091 gram (approx.)

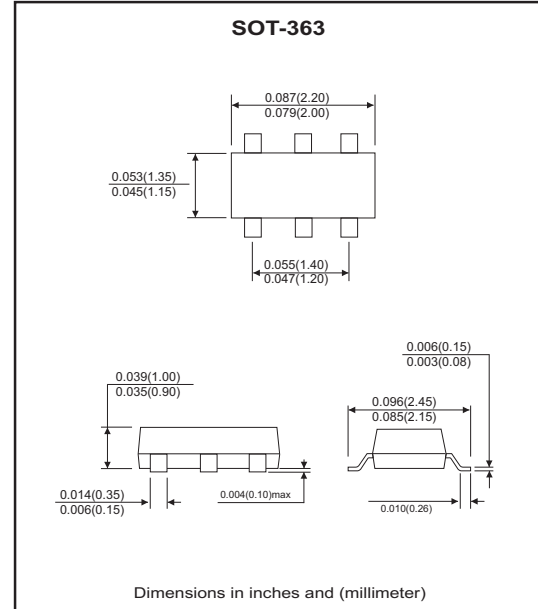

### Marking: E5U

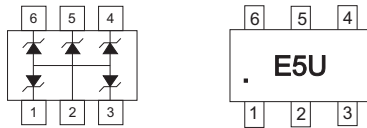

### Maximum Rating and Electrical Characteristics (at TA=25°C unless otherwise noted)

Parameter	Symbol	Conditions	Min	Typ	Max	Unit
Diode breakdown voltage	V <sub>BD</sub>	I <sub>R</sub> = 1mA	6.1		7.1	V
Leakage current	I <sub>L</sub>	V <sub>R</sub> = 3V		0.1	1.0	μA
Forward voltage	V <sub>F</sub>	I <sub>F</sub> = 5μA			1.2	V
Junction capacitance	C <sub>T</sub>	V <sub>R</sub> = 0V, f = 1MHz		60	80	pF
Clamping voltage	V <sub>C</sub>	I <sub>PP</sub> = 1A, T <sub>P</sub> =8/20us I <sub>PP</sub> = 8A, T <sub>P</sub> =8/20us			8 10	V
ESD capability	ESD	C = 150pF, R = 300ohm, forward and reverse 10 pulses	8			kV
Peak pulse power	P <sub>PP</sub>				80	W
Operation temperature	T <sub>J</sub>				125	°C
Storage temperature	T <sub>STG</sub>		-55		150	°C

## RATING AND CHARACTERISTIC CURVES (CPDV6-5V0U)

Fig. 1 - 8/20us Peak pulse current wave form acc. IEC 61000-4-5

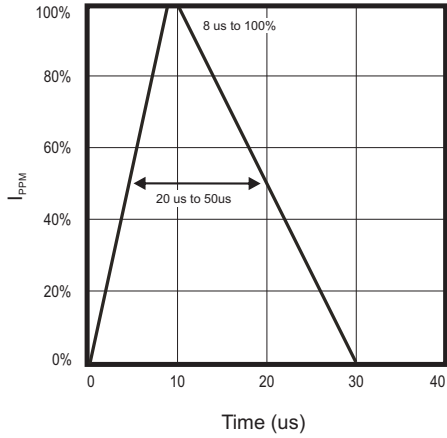

Fig. 2 - Power rating derating curve

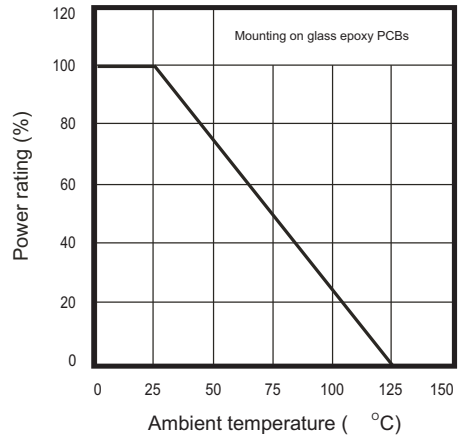

Fig. 3 - Clamping voltage vs. peak pulse current

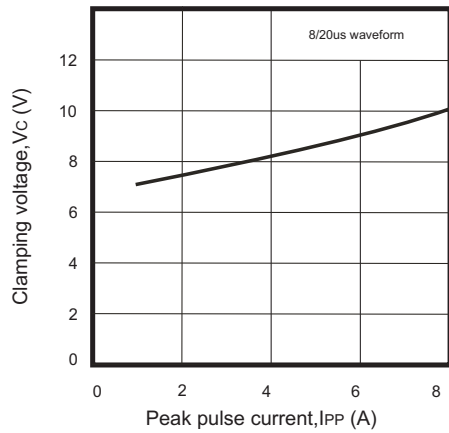
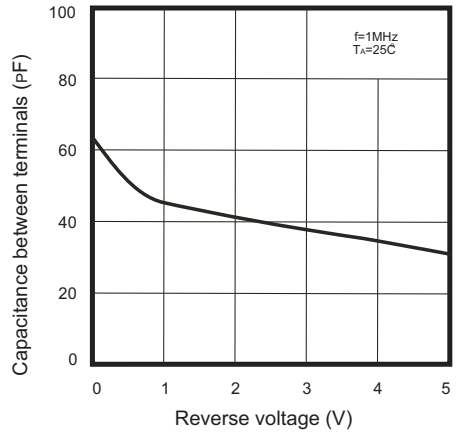
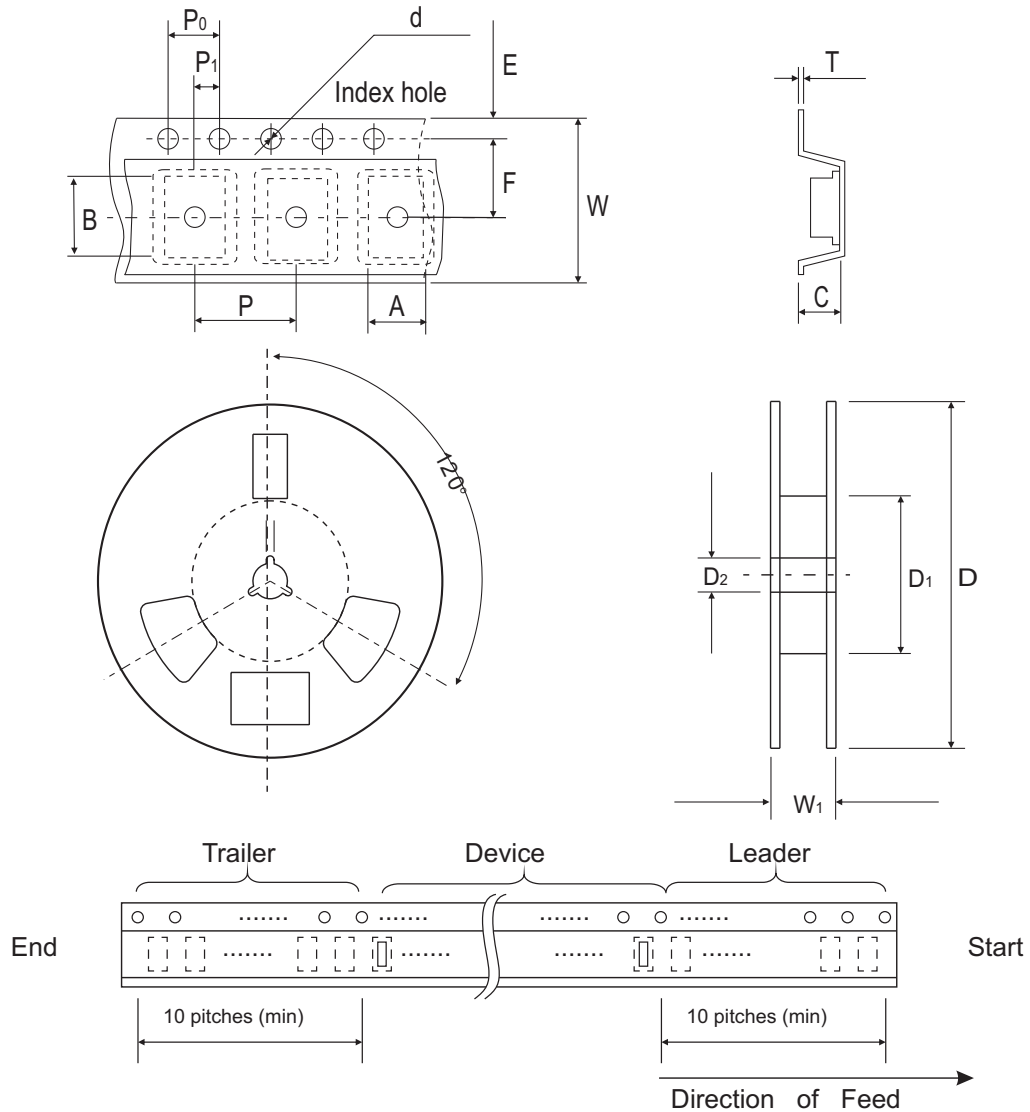

Fig. 4 - Capacitance between terminals characteristics



## Reel Taping Specification



SOT-363	SYMBOL	A	B	C	d	D	D1	D2
	(mm)	2.20 ± 0.10	2.40 ± 0.10	1.35 ± 0.10	1.55 ± 0.10	178 ± 1	50.0 MIN.	13.0 ± 0.20
	(inch)	0.087 ± 0.004	0.094 ± 0.004	0.053 ± 0.004	0.061 ± 0.004	7.008 ± 0.040	1.969 MIN.	0.512 ± 0.008

SOT-363	SYMBOL	E	F	P	P0	P1	W	W1
	(mm)	1.75 ± 0.10	3.50 ± 0.05	4.00 ± 0.10	4.00 ± 0.10	2.00 ± 0.05	8.00 ± 0.30	14.4 MAX.
	(inch)	0.069 ± 0.004	0.138 ± 0.002	0.157 ± 0.004	0.157 ± 0.004	0.079 ± 0.002	0.315 ± 0.012	0.567 MAX.

## Marking Code

Part Number	Marking Code
CPDV6-5V0U	E5U

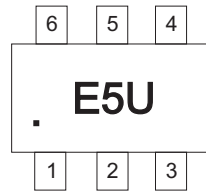

## Suggested PAD Layout

SIZE	SOT-363	
	(mm)	(inch)
A	0.80	0.031
B	0.35	0.014
C	1.30	0.051
D	1.94	0.076
E	2.74	0.108

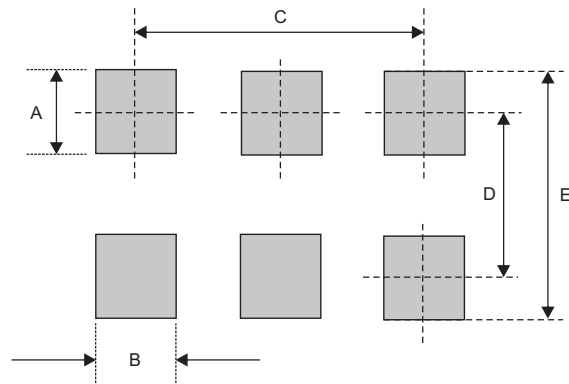

## Standard Package

Case Type	Qty per Reel	Reel Size
	(Pcs)	(inch)
SOT-363	3000	7