


#### Agency Approvals

AGENCY	AGENCY FILE NUMBER
	E128662/E230531

#### Maximum Ratings and Thermal Characteristics (T<sub>A</sub>=25°C unless otherwise noted)

Parameter	Symbol	Value	Unit
Peak Pulse Power Dissipation by 10x1000µs test waveform (Fig.1) (Note 1)	P <sub>PPM</sub>	5000	W
Steady State Power Dissipation on infinite heat sink at T <sub>L</sub> =75°C (Fig. 5)	P <sub>D</sub>	8.0	W
Peak Forward Surge Current, 8.3ms Single Half Sine Wave Unidirectional only (Note 2)	I <sub>FSM</sub>	400	A
Maximum Instantaneous Forward Voltage at 100A for Unidirectional only (Note 3)	V <sub>F</sub>	3.5/5.0	V
Operating Junction and Storage Temperature Range	T <sub>J</sub> , T <sub>STG</sub>	-55 to 175	°C
Typical Thermal Resistance Junction to Lead	R <sub>θJL</sub>	8.0	°C/W
Typical Thermal Resistance Junction to Ambient	R <sub>θJA</sub>	40	°C/W

#### Notes:

1. Non-repetitive current pulse, per Fig. 3 and derated above T<sub>A</sub> = 25°C per Fig. 2.
2. Measured on 8.3ms single half sine wave or equivalent square wave, duty cycle=4 per minute maximum.
3. V<sub>F</sub><3.5V for devices of V<sub>BR</sub> ≤ 200V and V<sub>F</sub><5.0V for devices of V<sub>BR</sub> ≥ 201V.

#### Description

The 5KP Series is designed specifically to protect sensitive electronic equipment from voltage transients induced by lightning and other transient voltage events.

#### Features

- Halogen-Free
- RoHS compliant
- Typical maximum temperature coefficient  
ΔV<sub>BR</sub> = 0.1% × V<sub>BR</sub> @25°C × ΔT
- Glass passivated chip junction in P600 package
- 5000W peak pulse capability at 10×1000µs waveform, repetition rate (duty cycles):0.01%
- Fast response time: typically less than 1.0ps from 0 Volts to BV min
- Excellent clamping capability
- Low incremental surge resistance
- Typical I<sub>R</sub> less than 2µA above 12V
- High temperature soldering guaranteed: 260°C/40 seconds / 0.375" (9.5mm) lead length, 5 lbs., (2.3kg) tension
- Plastic package has Underwriters Laboratory Flammability classification 94V-O
- Matte Tin Lead-free plated

#### Applications

TVS devices are ideal for the protection of I/O interfaces, V<sub>CC</sub> bus and other vulnerable circuits used in telecom, computer, industrial and consumer electronic applications.

# Transient Voltage Suppression Diodes

## Axial Leaded – 5000W > 5KP series

### Electrical Characteristics

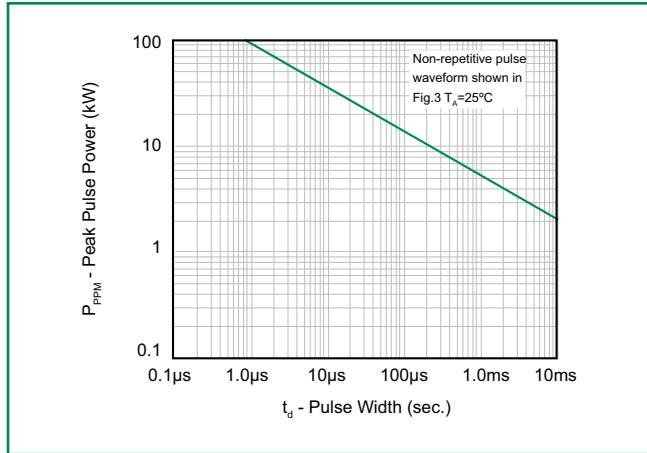
Part Number (Uni)	Part Number (Bi)	Reverse Stand off Voltage $V_R$ (Volts)	Breakdown Voltage $V_{BR}$ (Volts) @ $I_T$		Test Current $I_T$ (mA)	Maximum Clamping Voltage $V_C$ @ $I_{PP}$ (V)	Maximum Peak Pulse Current $I_{PP}$ (A)	Maximum Reverse Leakage $I_R$ @ $V_R$ ( $\mu$ A)	Agency Approval 
			MIN	MAX					
5KP5.0A	5KP5.0CA	5.0	6.40	7.00	50	9.2	554.3	5000	X
5KP6.0A	5KP6.0CA	6.0	6.67	7.37	50	10.3	495.1	5000	X
5KP6.5A	5KP6.5CA	6.5	7.22	7.98	50	11.2	455.4	2000	X
5KP7.0A	5KP7.0CA	7.0	7.78	8.60	50	12.0	425.0	1000	X
5KP7.5A	5KP7.5CA	7.5	8.33	9.21	5	12.9	395.3	250	X
5KP8.0A	5KP8.0CA	8.0	8.89	9.83	5	13.6	375.0	150	X
5KP8.5A	5KP8.5CA	8.5	9.44	10.40	5	14.4	354.2	50	X
5KP9.0A	5KP9.0CA	9.0	10.00	11.10	5	15.4	331.2	20	X
5KP10A	5KP10CA	10.0	11.10	12.30	5	17.0	300.0	15	X
5KP11A	5KP11CA	11.0	12.20	13.50	5	18.2	280.2	2	X
5KP12A	5KP12CA	12.0	13.30	14.70	5	19.9	256.3	2	X
5KP13A	5KP13CA	13.0	14.40	15.90	5	21.5	237.2	2	X
5KP14A	5KP14CA	14.0	15.60	17.20	5	23.2	219.8	2	X
5KP15A	5KP15CA	15.0	16.70	18.50	5	24.4	209.0	2	X
5KP16A	5KP16CA	16.0	17.80	19.70	5	26.0	196.2	2	X
5KP17A	5KP17CA	17.0	18.90	20.90	5	27.6	184.8	2	X
5KP18A	5KP18CA	18.0	20.00	22.10	5	29.2	174.7	2	X
5KP20A	5KP20CA	20.0	22.20	24.50	5	32.4	157.4	2	X
5KP22A	5KP22CA	22.0	24.00	26.90	5	35.5	143.7	2	X
5KP24A	5KP24CA	24.0	26.70	29.50	5	38.9	131.1	2	X
5KP26A	5KP26CA	26.0	28.90	31.90	5	42.1	121.1	2	X
5KP28A	5KP28CA	28.0	31.10	34.40	5	45.4	112.3	2	X
5KP30A	5KP30CA	30.0	33.30	36.80	5	48.4	105.4	2	X
5KP33A	5KP33CA	33.0	36.70	40.60	5	53.3	95.7	2	X
5KP36A	5KP36CA	36.0	40.00	44.20	5	58.1	87.8	2	X
5KP40A	5KP40CA	40.0	44.40	49.10	5	64.5	79.1	2	X
5KP43A	5KP43CA	43.0	47.80	52.80	5	69.4	73.5	2	X
5KP45A	5KP45CA	45.0	50.00	55.30	5	72.7	70.2	2	X
5KP48A	5KP48CA	48.0	53.30	58.90	5	77.4	65.9	2	X
5KP51A	5KP51CA	51.0	56.70	62.70	5	82.4	61.9	2	X
5KP54A	5KP54CA	54.0	60.00	66.30	5	87.1	58.6	2	X
5KP58A	5KP58CA	58.0	64.40	71.20	5	93.6	54.5	2	X
5KP60A	5KP60CA	60.0	66.70	73.70	5	96.8	52.7	2	X
5KP64A	5KP64CA	64.0	71.10	78.60	5	103.0	49.5	2	X
5KP70A	5KP70CA	70.0	77.80	86.00	5	113.0	45.1	2	X
5KP75A	5KP75CA	75.0	83.30	92.10	5	121.0	42.1	2	X
5KP78A	5KP78CA	78.0	86.70	95.80	5	126.0	40.5	2	X
5KP85A	5KP85CA	85.0	94.40	104.00	5	137.0	37.2	2	X
5KP90A	5KP90CA	90.0	100.00	111.00	5	146.0	34.9	2	X
5KP100A	5KP100CA	100.0	110.00	123.00	5	162.0	31.5	2	X
5KP110A	5KP110CA	110.0	122.00	135.00	5	177.0	28.8	2	X
5KP120A	5KP120CA	120.0	133.00	147.00	5	193.0	26.4	2	X
5KP130A	5KP130CA	130.0	144.00	159.00	5	209.0	24.4	2	X
5KP150A	5KP150CA	150.0	167.00	185.00	5	243.0	21.0	2	X
5KP160A	5KP160CA	160.0	178.00	197.00	5	259.0	19.7	2	X
5KP170A	5KP170CA	170.0	189.00	209.00	5	275.0	18.5	2	X
5KP180A	5KP180CA	180.0	200.00	221.00	5	292.0	17.5	2	X
5KP190A	5KP190CA	190.0	211.00	233.00	5	310.0	16.5	2	X
5KP200A	5KP200CA	200.0	222.00	246.00	5	329.2	15.5	2	X
5KP210A	5KP210CA	210.0	233.00	258.00	5	349.5	14.6	2	X
5KP220A	5KP220CA	220.0	244.00	270.00	5	371.1	13.7	2	X
5KP250A	5KP250CA	250.0	277.00	306.00	5	425.0	12.0	2	X

For bidirectional type having  $V_R$  of 10 volts and less, the  $I_R$  limit is double.

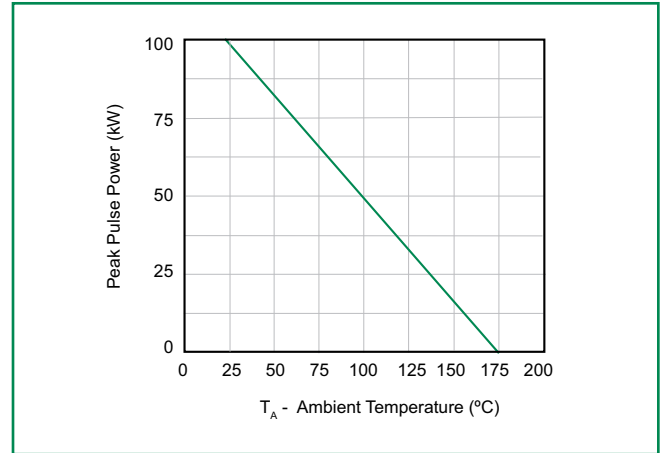
For parts without A, the  $V_{BR}$  is  $\pm 10\%$  and  $V_C$  is 5% higher than with A parts

### Ratings and Characteristic Curves ( $T_A=25^\circ\text{C}$ unless otherwise noted)

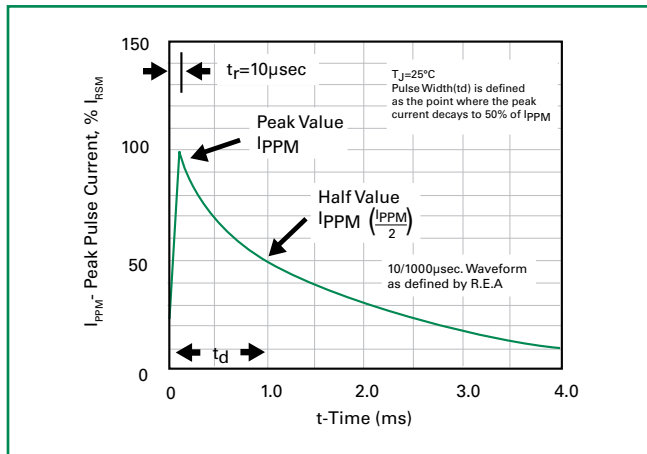
**Figure 1 - Peak Pulse Power Rating Curve**



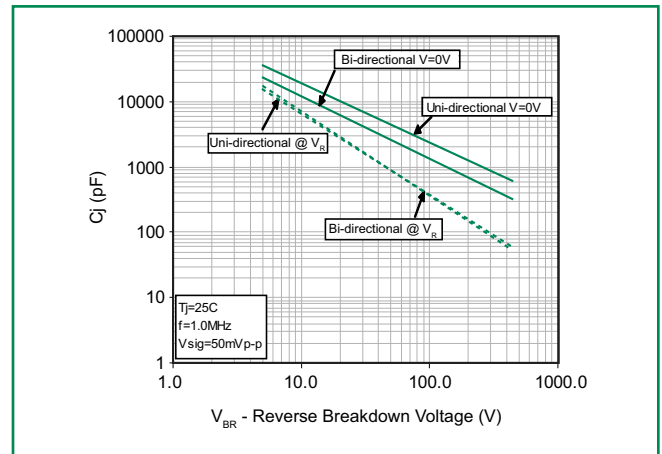
**Figure 2 - Pulse Derating Curve**



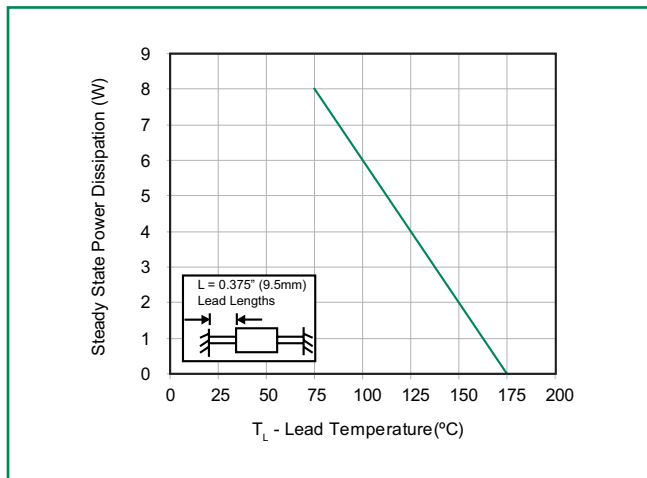
**Figure 3 - Pulse Waveform**



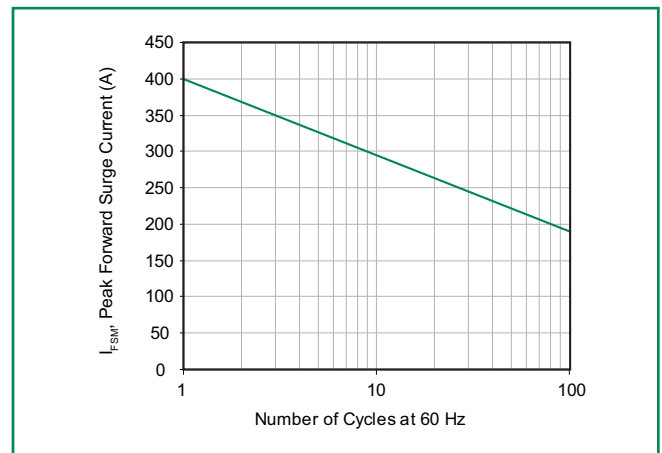
**Figure 4 - Typical Junction Capacitance**



**Figure 5 - Steady State Power Derating Curve**

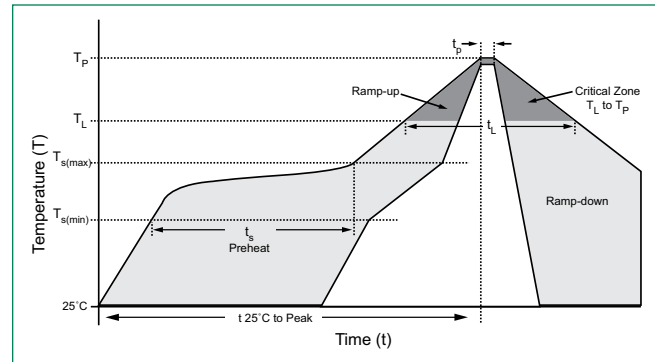


**Figure 6 - Maximum Non-Repetitive Peak Forward Surge Current**



### Soldering Parameters

Reflow Condition		Lead-free assembly
Pre Heat	- Temperature Min ( $T_{s(min)}$ )	150°C
	- Temperature Max ( $T_{s(max)}$ )	200°C
	- Time (min to max) ( $t_s$ )	60 – 180 secs
Average ramp up rate (Liquidus Temp ( $T_L$ ) to peak)		3°C/second max
$T_{s(max)}$ to $T_L$ - Ramp-up Rate		3°C/second max
Reflow	- Temperature ( $T_L$ ) (Liquidus)	217°C
	- Time (min to max) ( $t_s$ )	60 – 150 seconds
Peak Temperature ( $T_p$ )		260 <sup>+0/-5</sup> °C
Time within 5°C of actual peak Temperature ( $t_p$ )		20 – 40 seconds
Ramp-down Rate		6°C/second max
Time 25°C to peak Temperature ( $T_p$ )		8 minutes Max.
Do not exceed		280°C



### Flow/Wave Soldering (Solder Dipping)

<b>Peak Temperature :</b>	265°C
<b>Dipping Time :</b>	10 seconds
<b>Soldering :</b>	1 time

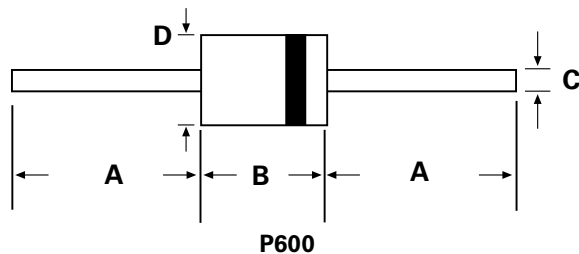
### Physical Specifications

<b>Weight</b>	0.07oz., 2.1g
<b>Case</b>	P600 molded plastic body over passivated junction.
<b>Polarity</b>	Color band denotes the cathode except Bipolar.
<b>Terminal</b>	Matte Tin axial leads, solderable per JESD22-B102D.

### Environmental Specifications

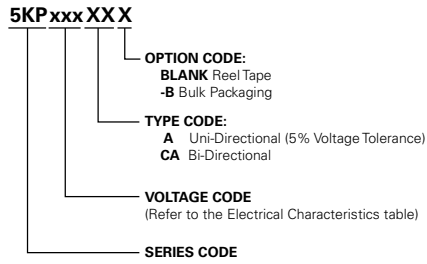
<b>Temperature Cycle</b>	JESD22-A104
<b>Pressure Cooker</b>	JESD 22-A102
<b>High Temp. Storage</b>	JESD22-A103
<b>HTRB</b>	JESD22-A108
<b>Thermal Shock</b>	JESD22-A106

### Dimensions

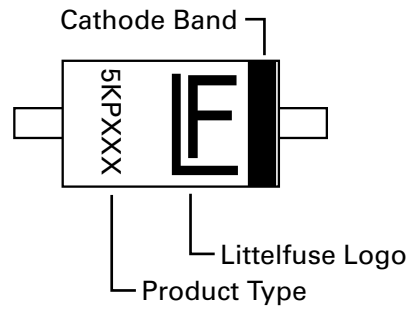


Dimensions	Inches		Millimeters	
	Min	Max	Min	Max
A	1.000	-	25.40	-
B	0.340	0.360	8.60	9.10
C	0.048	0.052	1.22	1.32
D	0.340	0.360	8.60	9.10

### Part Numbering System



### Part Marking System



### Packaging

Part Number	Component Package	Quantity	Packaging Option	Packaging Specification
5KPxxxXX	P600	800	Tape & Reel	EIA STD RS-296E
5KPxxxXX-B	P600	500	BULK	Littelfuse Concord Packing Spec. DM-0016