



Features

- RoHS compliant*
- Surface Mount SMC package
- Standoff Voltage: 5.0 to 170 volts
- Power Dissipation: 3000 watts

Applications

- IEC 61000-4-2 ESD (Min. Level 4)
- IEC 61000-4-4 EFT
- IEC 61000-4-5 Surge

SMLJ Transient Voltage Suppressor Diode Series

General Information

The markets of portable communications, computing and video equipment are challenging the semiconductor industry to develop increasingly smaller electronic components.

Bourns offers Transient Voltage Suppressor Diodes for surge and ESD protection applications, in compact chip package DO-214AB (SMC) size format. The Transient Voltage Suppressor series offers a choice of Working Peak Reverse Voltage from 5 V up to 170 V and Breakdown Voltage up to 200 V. Typical fast response times are less than 1.0 ns for unidirectional devices and less than 5.0 ns for bidirectional devices from 0 V to Minimum Breakdown Voltage.

Bourns® Chip Diodes conform to JEDEC standards, are easy to handle with standard pick and place equipment and the flat configuration minimizes roll away.

Electrical Characteristics (@ T_A = 25 °C Unless Otherwise Noted)

Parameter	Symbol	Value	Unit
Minimum Peak Pulse Power Dissipation (T _p = 1 ms) (Note 1,2)	P _{PK}	3000	Watts
Peak Forward Surge Current 8.3 ms Single Ha Sine Wave Superimposed on Rated Load (JEDEC Method) (Note 3)	I _{FSM}	300	Amps
Steady State Power Dissipation @ TL = 75 °C	P _{M(AV)}	5.0	Watts
Maximum Instantaneous Forward Voltage @ I _{PP} = 100 A (For Unidirectional Units Only)	V _F	(Note 5)	Volts
Operating Temperature Range	T _J	-55 to +150	°C
Storage Temperature Range	T _{STG}	-55 to +175	°C

1. Non-repetitive current pulse, per Pulse Waveform graph and derated above T_A = 25 °C per Pulse Derating Curve.
2. Thermal Resistance Junction to Lead.
3. 8.3 ms Single Ha-Sine Wave duty cycle = 4 pulses maximum per minute (unidirectional units only).
4. Single Phase, Ha Wave, 60 Hz, resistive or inductive load. For capacitive load, derate current by 20 %.
5. V_F = 3.5 V on SMLJ5.0A through SMLJ90A and V_F = 5.0 V on SMLJ100A through SMLJ170A.



Asia-Pacific:

Tel: +886-2 2562-4117 • Fax: +886-2 2562-4116

Europe:

Tel: +41-41 768 5555 • Fax: +41-41 768 5510

The Americas:

Tel: +1-951 781-5500 • Fax: +1-951 781-5700

www.bourns.com

How to Order

SMLJ 5.0 CA

Package _____
SMLJ = SMC/DO-214AB

Working Peak Reverse Voltage _____
5.0 = 5.0 V_{RWM} (Volts)

Suffix _____
A = 5 % Tolerance Unidirectional Device
CA = 5 % Tolerance Bidirectional Device

*RoHS Directive 2002/95/EC Jan 27 2003 including Annex.
Specifications are subject to change without notice.
Customers should verify actual device performance in their specific applications.

SMLJ Transient Voltage Suppressor Diode Series

BOURNS®

Electrical Characteristics (@ T_A = 25 °C Unless Otherwise Noted)

Unidirectional Device		Bidirectional Device		Breakdown Voltage V _{BR} (Volts)			Working Peak Reverse Voltage	Maximum Reverse Leakage @ V _{RWM}	Maximum Reverse Voltage @ I _{RSM}	Maximum Reverse Surge Current
Part Number	Part Marking	Part Number	Part Marking	Min.	Max.	@ I _T (mA)	V _{RWM} (Volts)	I _R (µA)	V _{RSM} (Volts)	I _{RSM} (Amps)
SMLJ5.0A	HDE	SMLJ5.0CA	IDE	6.40	7.82	10	5	1000	9.2	326.00
SMLJ6.0A	HDG	SMLJ6.0CA	IDG	6.67	8.15	10	6	1000	10.3	291.30
SMLJ6.5A	HDK	SMLJ6.5CA	IDK	7.22	7.98	10	6.5	500	11.2	267.90
SMLJ7.0A	HDM	SMLJ7.0CA	IDM	7.78	8.60	10	7	200	12	250.00
SMLJ7.5A	HDP	SMLJ7.5CA	IDP	8.33	9.21	1	7.5	100	12.9	232.60
SMLJ8.0A	HDR	SMLJ8.0CA	IDR	8.89	9.83	1	8	50	13.6	220.60
SMLJ8.5A	HDT	SMLJ8.5CA	IDT	9.44	10.43	1	8.5	25	14.4	208.40
SMLJ9.0A	HDV	SMLJ9.0CA	IDV	10.00	11.05	1	9	10	15.4	194.80
SMLJ10A	HDX	SMLJ10CA	IDX	11.10	12.27	1	10	5	17	176.40
SMLJ11A	HDZ	SMLJ11CA	IDZ	12.20	13.50	1	11	5	18.2	164.80
SMLJ12A	HEE	SMLJ12CA	IEE	13.30	14.70	1	12	5	19.9	150.60
SMLJ13A	HEG	SMLJ13CA	IEG	14.40	15.90	1	13	5	21.5	139.40
SMLJ14A	HEK	SMLJ14CA	IEK	15.60	17.20	1	14	5	23.2	129.40
SMLJ15A	HEM	SMLJ15CA	IEM	16.70	18.50	1	15	5	24.4	123.00
SMLJ16A	HEP	SMLJ16CA	IEP	17.80	19.70	1	16	5	26	115.40
SMLJ17A	HER	SMLJ17CA	IER	18.90	20.90	1	17	5	27.6	106.60
SMLJ18A	HET	SMLJ18CA	IET	20.00	22.10	1	18	5	29.2	102.80
SMLJ20A	HEV	SMLJ20CA	IEV	22.20	24.50	1	20	5	32.4	92.60
SMLJ22A	HEX	SMLJ22CA	IEX	24.40	27.00	1	22	5	35.5	84.40
SMLJ24A	HEZ	SMLJ24CA	IEZ	26.70	29.50	1	24	5	38.9	77.20
SMLJ26A	HFE	SMLJ26CA	IFE	28.90	31.90	1	26	5	42.1	71.20
SMLJ28A	HFG	SMLJ28CA	IFG	31.10	34.40	1	28	5	45.4	66.00
SMLJ30A	HFK	SMLJ30CA	IFK	33.30	36.80	1	30	5	48.4	62.00
SMLJ33A	HFM	SMLJ33CA	IFM	36.70	40.60	1	33	5	53.3	56.20
SMLJ36A	HFP	SMLJ36CA	IFP	40.00	44.20	1	36	5	58.1	51.60
SMLJ40A	HFR	SMLJ40CA	IFR	44.40	49.10	1	40	5	64.5	46.40
SMLJ43A	HFT	SMLJ43CA	IFT	47.80	52.80	1	43	5	69.4	43.20
SMLJ45A	HFV	SMLJ45CA	IFV	50.00	55.30	1	45	5	72.7	41.20
SMLJ48A	HFX	SMLJ48CA	IFX	53.30	58.90	1	48	5	77.4	38.80
SMLJ51A	HFZ	SMLJ51CA	IFZ	56.70	62.70	1	51	5	82.4	36.40
SMLJ54A	HGE	SMLJ54CA	IGE	60.00	66.30	1	54	5	87.1	34.40
SMLJ58A	HGG	SMLJ58CA	IGG	64.40	71.20	1	58	5	93.6	32.00
SMLJ60A	HGK	SMLJ60CA	IGK	66.70	73.70	1	60	5	96.8	31.00
SMLJ64A	HGM	SMLJ64CA	IGM	71.10	78.60	1	64	5	103	29.20
SMLJ70A	HGP	SMLJ70CA	IGP	77.80	86.00	1	70	5	113	26.60
SMLJ75A	HGR	SMLJ75CA	IGR	83.30	92.10	1	75	5	121	24.80
SMLJ78A	HGT	SMLJ78CA	IGT	86.70	95.80	1	78	5	126	22.80
SMLJ85A	HGV	SMLJ85CA	IGV	94.40	104.30	1	85	5	137	20.80
SMLJ90A	HGZ	SMLJ90CA	IGZ	100.00	110.50	1	90	5	146	20.60
SMLJ100A	HGX	SMLJ100CA	IGX	111.00	122.70	1	100	5	162	18.60
SMLJ110A	HHE	SMLJ110CA	IHE	122.00	134.80	1	110	5	177	16.80
SMLJ120A	HHG	SMLJ120CA	IHG	133.00	147.00	1	120	5	193	15.60
SMLJ130A	HHH	SMLJ130CA	IHH	144.00	159.20	1	130	5	209	14.40
SMLJ150A	HHM	SMLJ150CA	IHM	167.00	184.60	1	150	5	243	12.40
SMLJ160A	HHP	SMLJ160CA	IHP	178.00	196.70	1	160	5	259	11.60
SMLJ170A	HHR	SMLJ170CA	IHR	189.00	208.90	1	170	5	275	11.00

Notes:

1. Suffix 'A' denotes a 5 % tolerance unidirectional device.
2. Suffix 'CA' denotes a 5 % tolerance bidirectional device.
3. For bidirectional devices with a V_R of 10 volts or less, the I_R limit is double.
4. For unidirectional devices with a V_F max. of 3.5 V at an I_F of 35 A, 0.5 Sine Wave of 8.3 ms Pulse Width.

Specifications are subject to change without notice.
Customers should verify actual device performance in their specific applications.

SMLJ Transient Voltage Suppressor Diode Series

BOURNS®

Product Dimensions

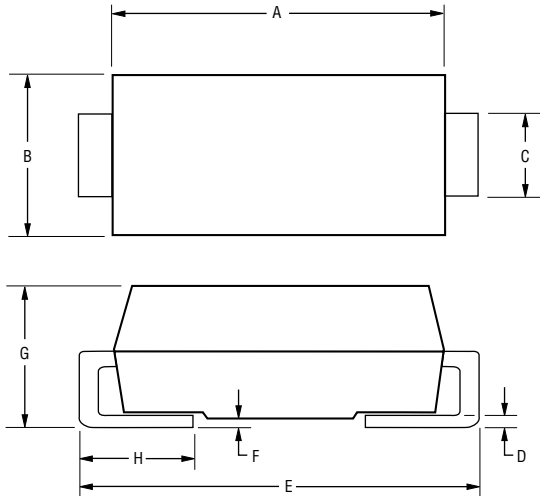

Dimension	SMC (DO-214AB)
A	$\frac{6.60 - 7.11}{(0.260 - 0.280)}$
B	$\frac{5.59 - 6.22}{(0.220 - 0.245)}$
C	$\frac{2.92 - 3.18}{(0.115 - 0.125)}$
D	$\frac{0.15 - 0.31}{(0.006 - 0.112)}$
E	$\frac{7.75 - 8.13}{(0.305 - 0.320)}$
F	$\frac{0.05 - 0.20}{(0.002 - 0.008)}$
G	$\frac{2.01 - 2.62}{(0.080 - 0.103)}$
H	$\frac{0.76 - 1.52}{(0.030 - 0.060)}$

DIMENSIONS: $\frac{\text{MM}}{(\text{INCHES})}$

Recommended Footprint

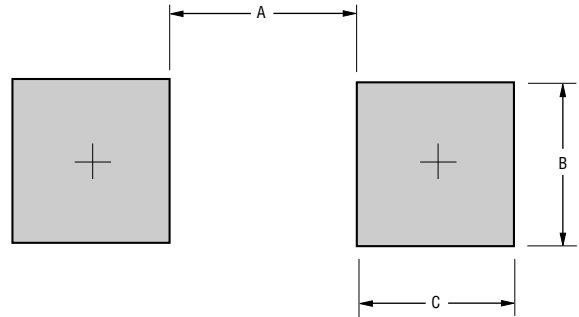

Dimension	SMC (DO-214AB)
A (Max.)	$\frac{4.69}{(0.185)}$
B (Min.)	$\frac{3.07}{(0.121)}$
C (Min.)	$\frac{1.52}{(0.060)}$

DIMENSIONS: $\frac{\text{MM}}{(\text{INCHES})}$

Physical Specifications

CaseMolded plastic per UL Class 94V-0
 Polarity Cathode band indicates unidirectional device
 No cathode band indicates bidirectional device
 Weight0.007 ounces / 0.21 grams

SMLJ Transient Voltage Suppressor Diode Series

BOURNS®

Rating & Characteristic Curves

Pulse Derating Curve

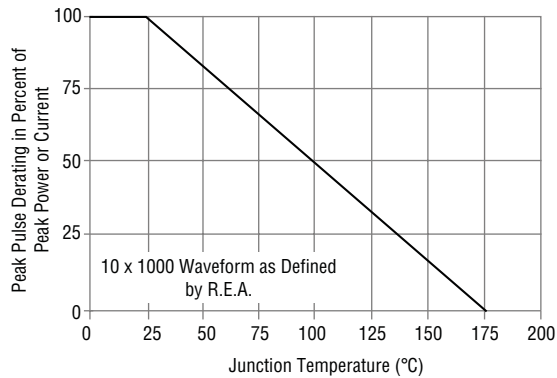

Maximum Non-Repetitive Surge Current

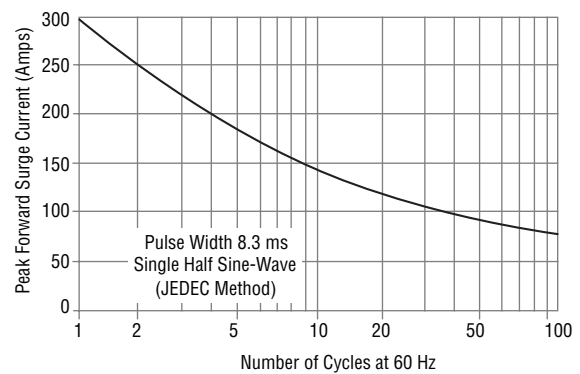

Pulse Waveform

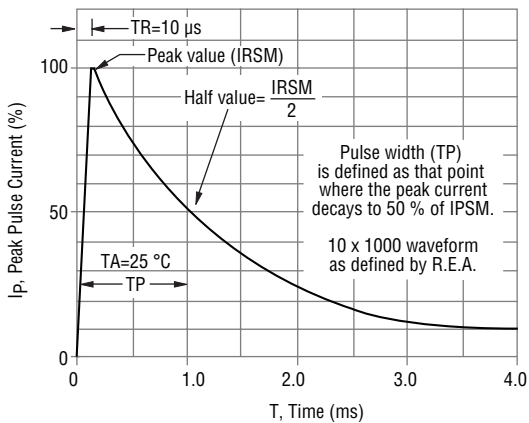

Typical Junction Capacitance

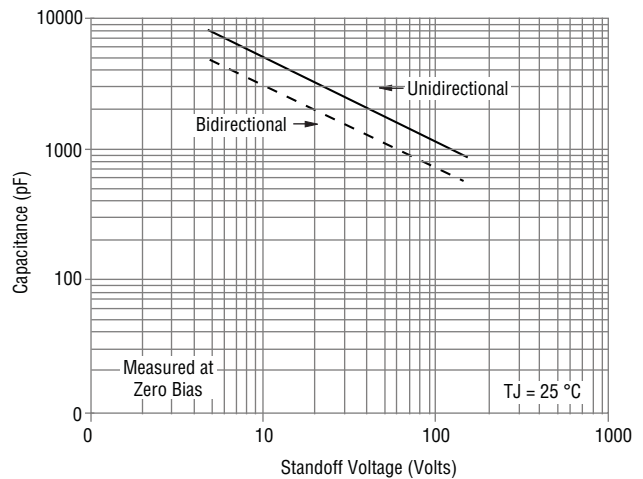

Pulse Rating Curve

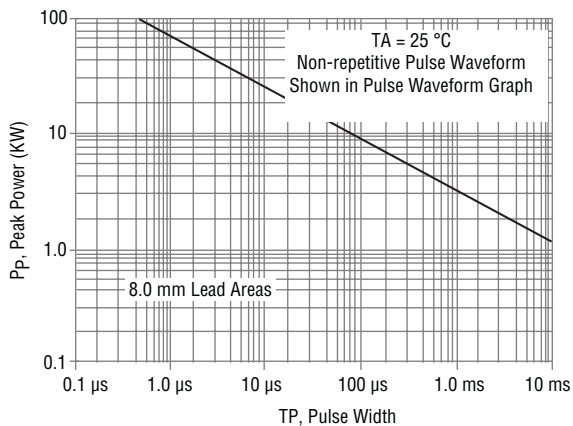

Steady State Power Derating Curve

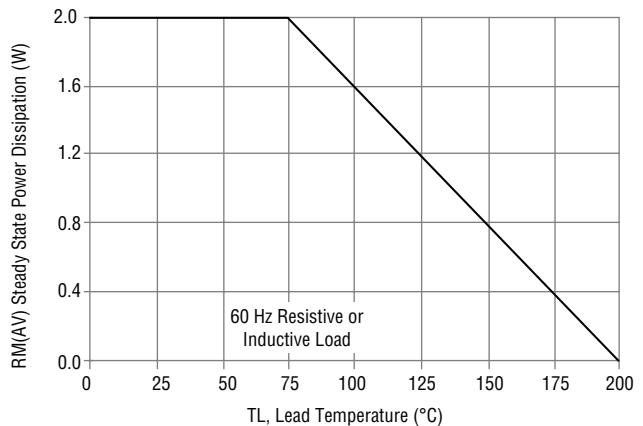

Specifications are subject to change without notice. Customers should verify actual device performance in their specific applications.

SMLJ Transient Voltage Suppressor Diode Series

BOURNS®

Packaging Information

The product will be dispensed in tape and reel format (see diagram below).

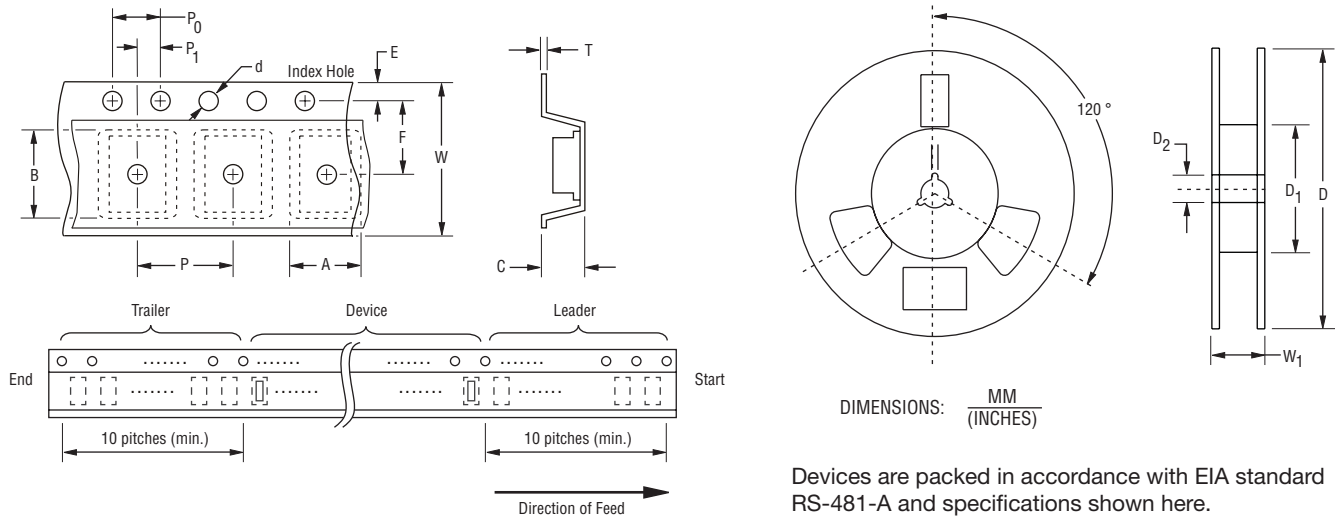

Item	Symbol	SMC (DO-214AB)
Carrier Width	A	7.22 ± 0.10 (0.284 - 0.004)
Carrier Length	B	8.11 ± 0.10 (0.319 ± 0.004)
Carrier Depth	C	2.36 ± 0.10 (0.093 ± 0.004)
Sprocket Hole	d	1.55 ± 0.05 (0.061 ± 0.002)
Reel Outside Diameter	D	330 (12.992)
Reel Inner Diameter	D ₁	50.0 (1.969) MIN.
Feed Hole Diameter	D ₂	13.0 ± 0.20 (0.512 ± 0.008)
Sprocket Hole Position	E	1.75 ± 0.10 (0.069 ± 0.004)
Punch Hole Position	F	7.50 ± 0.05 (0.295 ± 0.002)
Punch Hole Pitch	P	4.00 ± 0.10 (0.157 ± 0.004)
Sprocket Hole Pitch	P ₀	4.00 ± 0.10 (0.157 ± 0.004)
Embossment Center	P ₁	2.00 ± 0.05 (0.079 ± 0.002)
Overall Tape Thickness	T	0.30 ± 0.10 (0.012 ± 0.004)
Tape Width	W	16.00 ± 0.20 (0.630 ± 0.008)
Reel Width	W ₁	22.4 (0.882) MAX.
Quantity per Reel	--	3,000

04/10

Specifications are subject to change without notice.
Customers should verify actual device performance in their specific applications.