

# SP1001 Series - 8pF 15kV Unidirectional TVS Array

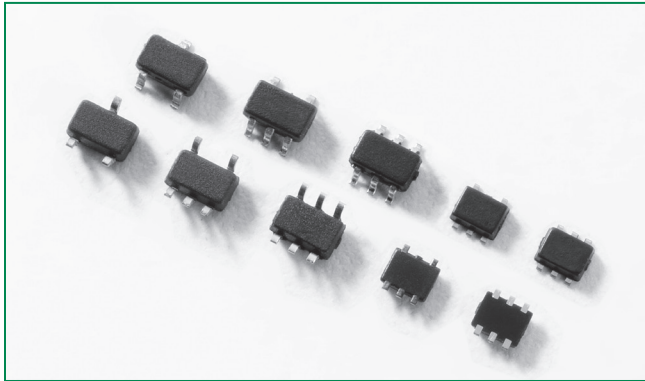

## Description

Zener diodes fabricated in a proprietary silicon avalanche technology protect each I/O pin to provide a high level of protection for electronic equipment that may experience destructive electrostatic discharges (ESD). These robust diodes can safely absorb repetitive ESD strikes above the maximum level specified in the IEC 61000-4-2 international standard (Level 4, ±8kV contact discharge) without performance degradation. Their very low loading capacitance also makes them ideal for protecting high-speed signal pins.

## Pinout

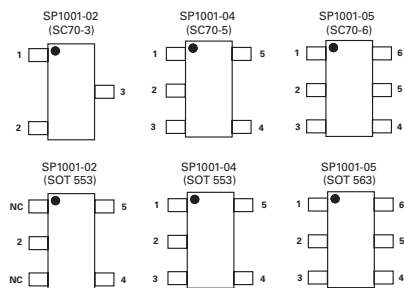

## Functional Block Diagram

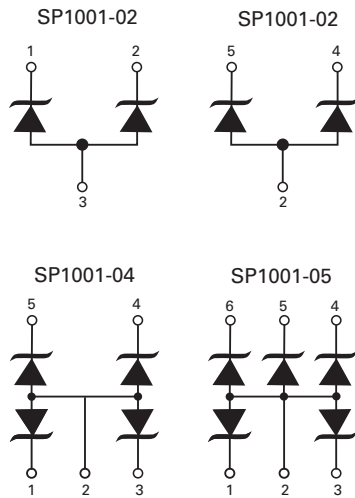

## Features

- Low capacitance of 8pF (TYP) per I/O
- ESD protection of ±15kV contact discharge, ±30kV air discharge, (Level 4, IEC61000-4-2)
- EFT protection, IEC61000-4-4, 40A (5/50ns)
- Low leakage current of 0.5µA (MAX) at 5V
- Small package saves board space
- Lightning Protection, IEC61000-4-5, 2A (8/20µs)

## Applications

- Computer Peripherals
- Mobile Phones
- Digital Cameras
- Desktops/Notebooks
- LCD/PDPTVs
- Set Top Boxes
- DVD Players
- MP3/PMP

## Application Example

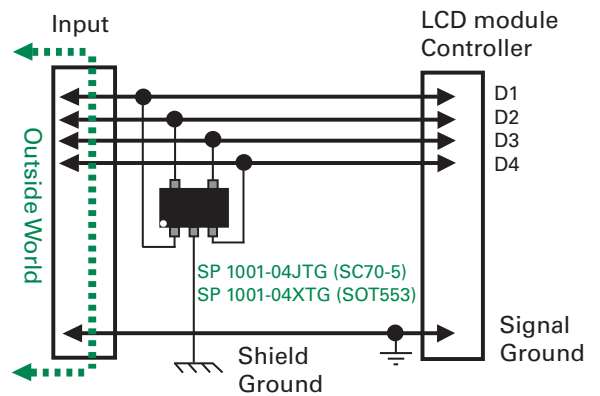

Life Support Note:

**Not Intended for Use in Life Support or Life Saving Applications**

The products shown herein are not designed for use in life sustaining or life saving applications unless otherwise expressly indicated.

### Absolute Maximum Ratings

Symbol	Parameter	Value	Units
$I_{PP}$	Peak Current ( $t_p=8/20\mu s$ )	2	A
$T_{OP}$	Operating Temperature	-40 to 85	°C
$T_{STOR}$	Storage Temperature	-60 to 150	°C

CAUTION: Stresses above those listed in "Absolute Maximum Ratings" may cause permanent damage to the device. This is a stress only rating and operation of the device at these or any other conditions above those indicated in the operational sections of this specification is not implied.

### Thermal Information

Parameter	Rating	Units
Storage Temperature Range	-65 to 150	°C
Maximum Junction Temperature	150	°C
Maximum Lead Temperature (Soldering 10s)	260	°C

### Electrical Characteristics ( $T_{OP} = 25^\circ C$ )

Parameter	Symbol	Test Conditions	Min	Typ	Max	Units
Forward Voltage Drop	$V_F$	$I_F=10mA$	0.7	0.9	1.2	V
Reverse Voltage Drop	$V_R$	$I_R=1mA$	7.0	7.8	8.5	V
Reverse Standoff Voltage	$V_{RWM}$	$I_R \leq 1\mu A$			5.5	V
Reverse Leakage Current	$I_{LEAK}$	$V_R=5V$			0.5	$\mu A$
Clamp Voltage <sup>1</sup>	$V_C$	$I_{PP}=1A, t_p=8/20\mu s, Fwd$		8.0	11.0	V
		$I_{PP}=2A, t_p=8/20\mu s, Fwd$		9.7	13.0	V
Dynamic Resistance	$R_{DYN}$	$(V_{C2} - V_{C1}) / (I_{PP2} - I_{PP1})$		1.7		$\Omega$
ESD Withstand Voltage <sup>1,2</sup>	$V_{ESD}$	IEC61000-4-2 (Contact)	$\pm 15$			kV
		IEC61000-4-2 (Air)	$\pm 30$			kV
Diode Capacitance <sup>1</sup>	$C_D$	Reverse Bias=0V		12		pF
		Reverse Bias=2.5V		8		pF
		Reverse Bias=5V		7		pF

Notes:

<sup>1</sup> Parameter is guaranteed by device characterization

<sup>2</sup> A minimum of 1,000 ESD pulses are applied at 1s intervals between the anode and common cathode of each diode

### Capacitance vs. Reverse Bias

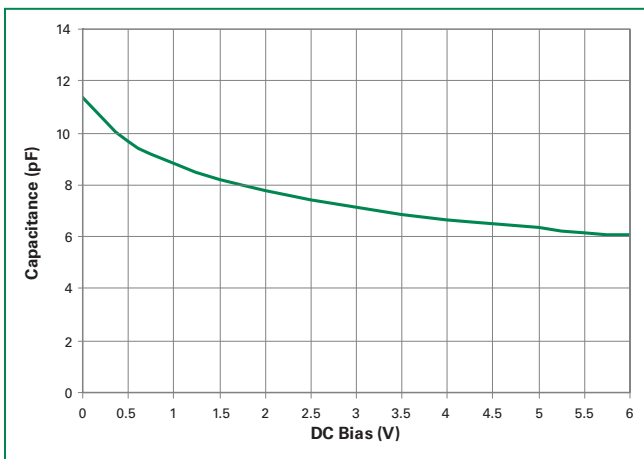

### Design Consideration

Because of the fast rise-time of the ESD transient, placement of ESD devices is a key design consideration. To achieve optimal ESD suppression, the devices should be placed on the circuit board as close to the source of the ESD transient as possible. Install the ESD suppressors directly behind the connector so that they are the first board-level circuit component encountered by the ESD transient. They are connected from signal/data line to ground.

**Soldering Parameters**

Reflow Condition		Pb – Free assembly
Pre Heat	- Temperature Min ( $T_{s(min)}$ )	150°C
	- Temperature Max ( $T_{s(max)}$ )	200°C
	- Time (min to max) ( $t_s$ )	60 – 180 secs
Average ramp up rate (Liquidus) Temp ( $T_L$ ) to peak		3°C/second max
$T_{s(max)}$ to $T_L$ - Ramp-up Rate		3°C/second max
Reflow	- Temperature ( $T_L$ ) (Liquidus)	217°C
	- Temperature ( $t_L$ )	60 – 150 seconds
Peak Temperature ( $T_p$ )		250 <sup>+0/-5</sup> °C
Time within 5°C of actual peak Temperature ( $t_p$ )		20 – 40 seconds
Ramp-down Rate		6°C/second max
Time 25°C to peak Temperature ( $T_p$ )		8 minutes max.
Do not exceed		260°C

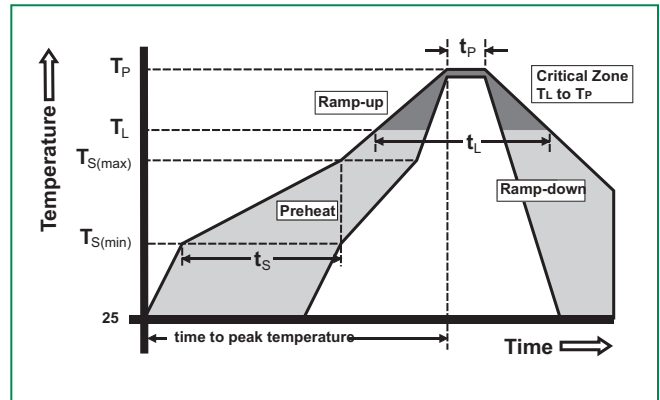

**Part Numbering System**

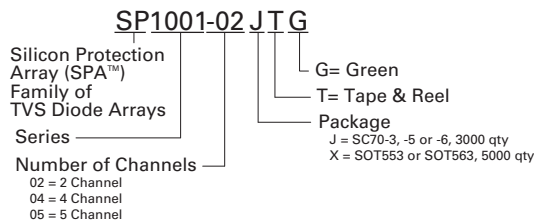

**Part Marking System**

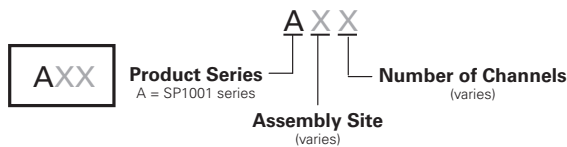

**Ordering Information**

Part Number	Package	Marking	Min. Order Qty.
SP1001-02JTG	SC70-3	Ax2	3000
SP1001-02XTG	SOT553	Ax2	5000
SP1001-04JTG	SC70-5	Ax4	3000
SP1001-04XTG	SOT553	Ax4	5000
SP1001-05JTG	SC70-6	Ax5	3000
SP1001-05XTG	SOT563	Ax5	5000

**Product Characteristics**

<b>Lead Plating</b>	Matte Tin (SC70-x) Pre-Plated Frame (SOT5x3)
<b>Lead Material</b>	Copper Alloy
<b>Lead Coplanarity</b>	0.0004 inches (0.102mm)
<b>Substitute Material</b>	Silicon
<b>Body Material</b>	Molded Epoxy
<b>Flammability</b>	UL94-V-0

Notes :

1. All dimensions are in millimeters
2. Dimensions include solder plating.
3. Dimensions are exclusive of mold flash & metal burr.
4. All specifications comply to JEDEC SPEC MO-203 Issue A
5. Blo is facing up for mold and facing down for trim/form, i.e. reverse trim/form.
6. Package surface matte finish VDI 11-13.

**Package Dimensions — SC70**

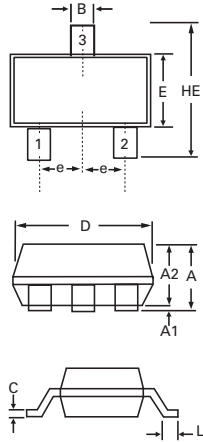

**SC70-3**

Solder Pad Layout

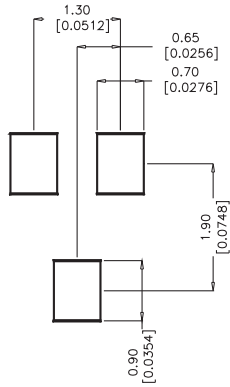

Package	SC70-3			
Pins	3			
JEDEC	MO-203 Issue A			
	Millimeters		Inches	
	Min	Max	Min	Max
<b>A</b>	0.80	1.10	0.031	0.043
<b>A1</b>	0.00	0.10	0.000	0.004
<b>A2</b>	0.70	1.00	0.028	0.039
<b>B</b>	0.15	0.30	0.006	0.012
<b>c</b>	0.08	0.25	0.003	0.010
<b>D</b>	1.85	2.25	0.073	0.089
<b>E</b>	1.15	1.35	0.045	0.053
<b>e</b>	0.66 BSC		0.026 BSC	
<b>HE</b>	2.00	2.40	0.079	0.094
<b>L</b>	0.26	0.46	0.010	0.018

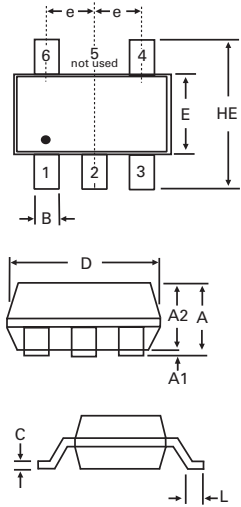

**SC70-5**

Solder Pad Layout

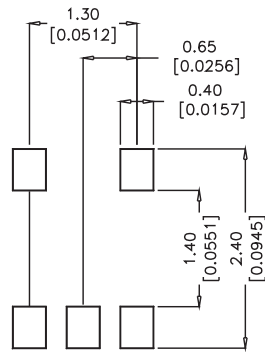

Package	SC70-5			
Pins	5			
JEDEC	MO-203 Issue A			
	Millimeters		Inches	
	Min	Max	Min	Max
<b>A</b>	0.80	1.10	0.031	0.043
<b>A1</b>	0.00	0.10	0.000	0.004
<b>A2</b>	0.70	1.00	0.028	0.039
<b>B</b>	0.15	0.30	0.006	0.012
<b>c</b>	0.08	0.25	0.003	0.010
<b>D</b>	1.85	2.25	0.073	0.089
<b>E</b>	1.15	1.35	0.045	0.053
<b>e</b>	0.65 BSC		0.026 BSC	
<b>HE</b>	2.00	2.40	0.079	0.094
<b>L</b>	0.26	0.46	0.010	0.018

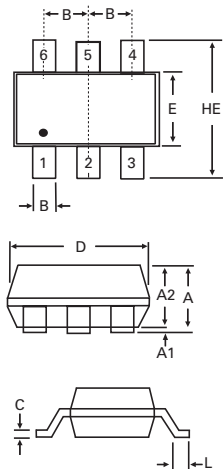

**SC70-6**

Solder Pad Layout

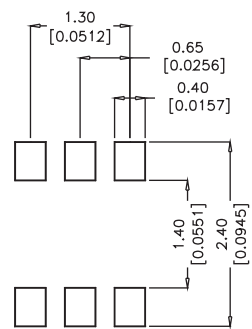

Package	SC70-6			
Pins	6			
JEDEC	MO-203 Issue A			
	Millimeters		Inches	
	Min	Max	Min	Max
<b>A</b>	0.80	1.10	0.031	0.043
<b>A1</b>	0.00	0.10	0.000	0.004
<b>A2</b>	0.70	1.00	0.028	0.039
<b>B</b>	0.15	0.30	0.006	0.012
<b>c</b>	0.08	0.25	0.003	0.010
<b>D</b>	1.85	2.25	0.073	0.089
<b>E</b>	1.15	1.35	0.045	0.053
<b>e</b>	0.65 BSC		0.026 BSC	
<b>HE</b>	2.00	2.40	0.079	0.094
<b>L</b>	0.26	0.46	0.010	0.018

**Package Dimensions – SOT5**

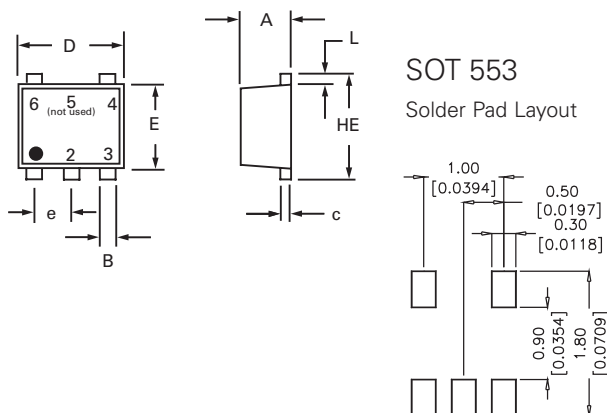

Package	SOT 553			
Pins	5			
	Millimeters		Inches	
	Min	Max	Min	Max
<b>A</b>	0.50	0.60	0.020	0.024
<b>B</b>	0.17	0.27	0.007	0.011
<b>c</b>	0.08	0.18	0.003	0.007
<b>D</b>	1.50	1.70	0.059	0.067
<b>E</b>	1.10	1.30	0.043	0.051
<b>e</b>	0.50 BSC		0.020 BSC	
<b>L</b>	0.10	0.30	0.004	0.012
<b>HE</b>	1.50	1.70	0.059	0.067

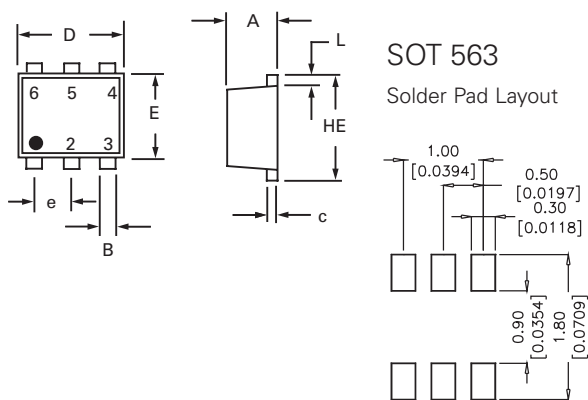

Package	SOT 563			
Pins	6			
	Millimeters		Inches	
	Min	Max	Min	Max
<b>A</b>	0.50	0.60	0.020	0.024
<b>B</b>	0.17	0.27	0.007	0.011
<b>c</b>	0.08	0.18	0.003	0.007
<b>D</b>	1.50	1.70	0.059	0.067
<b>E</b>	1.10	1.30	0.043	0.051
<b>e</b>	0.50 BSC		0.020 BSC	
<b>L</b>	0.10	0.30	0.004	0.012
<b>HE</b>	1.50	1.70	0.059	0.067

**Embossed Carrier Tape & Reel Specification – SC70-3**

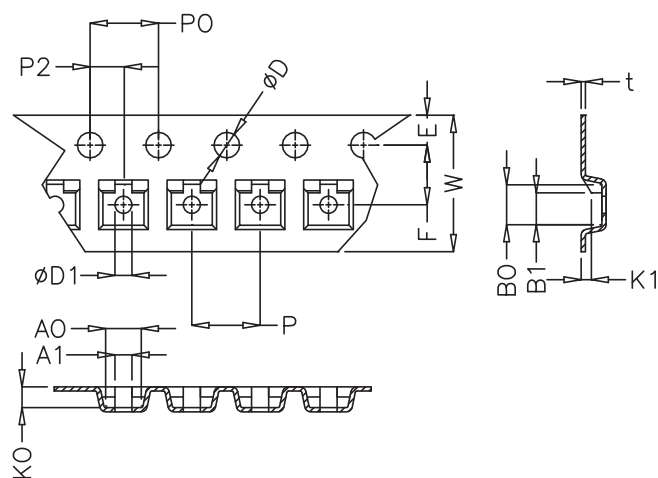

Dimensions	Millimetres		Inches	
	Min	Max	Min	Max
<b>E</b>	1.65	1.85	0.065	0.073
<b>F</b>	3.45	3.55	0.135	0.139
<b>P2</b>	1.95	2.05	0.077	0.081
<b>D</b>	1.40	1.60	0.055	0.063
<b>D1</b>	1.00	1.25	0.039	0.049
<b>P0</b>	3.90	4.10	0.154	0.161
<b>10P0</b>	40.0 +/- 0.20		1.574 +/- 0.008	
<b>W</b>	7.70	8.10	0.303	0.318
<b>P</b>	3.90	4.10	0.153	0.161
<b>A0</b>	2.30	2.50	0.090	0.098
<b>A1</b>	1.00 Ref		0.039 Ref	
<b>B0</b>	2.30	2.50	0.090	0.098
<b>B1</b>	1.90 Ref		0.074	
<b>K0</b>	1.10	1.30	0.043	0.051
<b>K1</b>	0.60 Ref		0.023 Ref	
<b>t</b>	0.27 max		0.010	

**Embossed Carrier Tape & Reel Specification – SC70-5 and SC70-6**

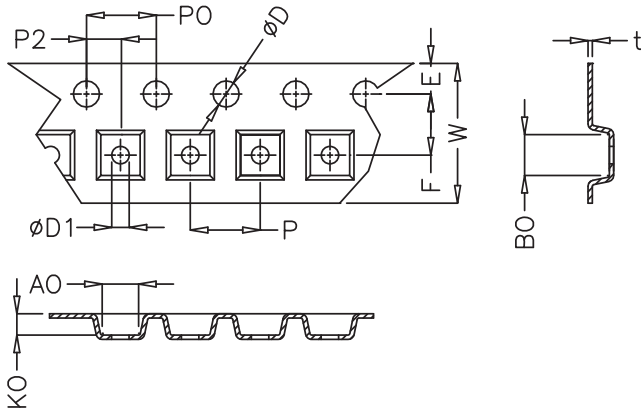

Dimensions				
	Millimetres		Inches	
	Min	Max	Min	Max
<b>E</b>	1.65	1.85	0.065	0.073
<b>F</b>	3.45	3.55	0.135	0.139
<b>P2</b>	1.95	2.05	0.077	0.081
<b>D</b>	1.40	1.60	0.055	0.063
<b>D1</b>	1.00	1.25	0.039	0.049
<b>P0</b>	3.90	4.10	0.154	0.161
<b>10P0</b>	40.0 +/- 0.20		1.574 +/- 0.008	
<b>W</b>	7.70	8.10	0.303	0.318
<b>P</b>	3.90	4.10	0.153	0.161
<b>A0</b>	2.14	2.34	0.084	0.092
<b>B0</b>	2.24	2.44	0.088	0.096
<b>K0</b>	1.12	1.32	0.044	0.052
<b>t</b>	0.27 max		0.010 max	

**Embossed Carrier Tape & Reel Specification – SOT553 and SOT563**

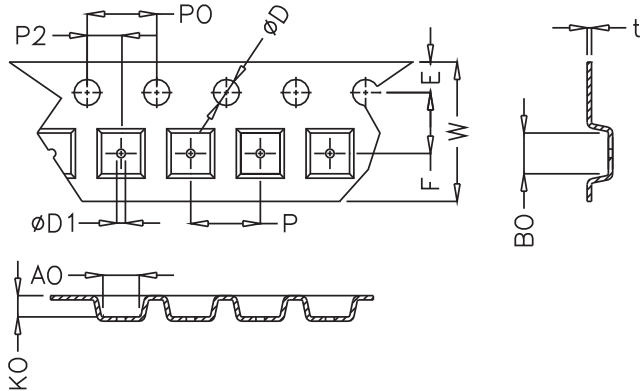

Dimensions				
	Millimetres		Inches	
	Min	Max	Min	Max
<b>E</b>	1.65	1.85	0.065	0.073
<b>F</b>	3.45	3.55	0.135	0.139
<b>P2</b>	1.95	2.05	0.077	0.081
<b>D</b>	1.40	1.60	0.055	0.063
<b>D1</b>	0.45	0.55	0.017	0.021
<b>P0</b>	3.90	4.1	0.154	0.161
<b>10P0</b>	40.0 +/- 0.20		1.574 +/- 0.008	
<b>W</b>	7.70	8.10	0.303	0.318
<b>P</b>	3.90	4.10	0.153	0.161
<b>A0</b>	1.73	1.83	0.068	0.072
<b>B0</b>	1.73	1.83	0.068	0.072
<b>K0</b>	0.64	0.74	0.025	0.029
<b>t</b>	0.22 max		.009 max	