



Features

- RoHS compliant*
- Surface Mount SMA package
- Standoff Voltage: 5.0 to 170 volts
- Power Dissipation: 400 watts

Applications

- IEC 61000-4-2 ESD (Min. Level 4)
- IEC 61000-4-4 EFT
- IEC 61000-4-5 Surge

SMAJ Transient Voltage Suppressor Diode Series

General Information

The markets of portable communications, computing and video equipment are challenging the semiconductor industry to develop increasingly smaller electronic components.

Bourns offers Transient Voltage Suppressor Diodes for surge and ESD protection applications, in compact chip package DO-214AC (SMA) size format. The Transient Voltage Suppressor series offers a choice of Working Peak Reverse Voltage from 5 V up to 170 V and Breakdown Voltage up to 200 V. Typical fast response times are less than 1.0 ns for unidirectional devices and less than 5.0 ns for bidirectional devices from 0 V to Minimum Breakdown Voltage.

Bourns® Chip Diodes conform to JEDEC standards, are easy to handle with standard pick and place equipment and the flat configuration minimizes roll away.

Electrical Characteristics (@ T_A = 25 °C Unless Otherwise Noted)

Parameter	Symbol	Value	Unit
Minimum Peak Pulse Power Dissipation (T _P = 1 ms) (Note 1,2)	P _{PK}	400	Watts
Peak Forward Surge Current 8.3 ms Single Half Sine Wave Superimposed on Rated Load (JEDEC Method) (Note 3)	I _{FSM}	40	Amps
Steady State Power Dissipation @ TL = 75 °C	P _{M(AV)}	1.0	Watts
Maximum Instantaneous Forward Voltage @ I _{PP} = 35 A (For Unidirectional Units Only)	V _F	3.5	Volts
Operating Temperature Range	T _J	-55 to +150	°C
Storage Temperature Range	T _{STG}	-55 to +175	°C

1. Non-repetitive current pulse, per Pulse Waveform graph and derated above T_A = 25 °C per Pulse Derating Curve.
2. Thermal Resistance Junction to Lead.
3. 8.3 ms Single Half-Sine Wave duty cycle = 4 pulses maximum per minute (unidirectional units only).
4. Single Phase, Half Wave, 60 Hz, resistive or inductive load. For capacitive load, derate current by 20 %.



Asia-Pacific:

Tel: +886-2 2562-4117 • Fax: +886-2 2562-4116

Europe:

Tel: +41-41 768 5555 • Fax: +41-41 768 5510

The Americas:

Tel: +1-951 781-5500 • Fax: +1-951 781-5700

www.bourns.com

How to Order

Package _____ SMAJ 5.0 CA
 SMAJ = SMA/DO-214AC
 Working Peak Reverse Voltage _____
 5.0 = 5.0 VRWM (Volts)
 Suffix _____
 A = 5 % Tolerance Unidirectional Device
 CA = 5 % Tolerance Bidirectional Device

*RoHS Directive 2002/95/EC Jan 27 2003 including Annex.
 Specifications are subject to change without notice.
 Customers should verify actual device performance in their specific applications.

SMAJ Transient Voltage Suppressor Diode Series

BOURNS®

Electrical Characteristics (@ T_A = 25 °C Unless Otherwise Noted)

Unidirectional Device		Bidirectional Device		Breakdown Voltage V _{BR} (Volts)			Working Peak Reverse Voltage	Maximum Reverse Leakage @ V _{RWM}	Maximum Reverse Voltage @ I _{RSM}	Maximum Reverse Surge Current
Part Number	Part Marking	Part Number	Part Marking	Min.	Max.	@ I _T (mA)	V _{RWM} (Volts)	I _R (µA)	V _{RSM} (Volts)	I _{RSM} (Amps)
SMAJ5.0A	HE	SMAJ5.0CA	TE	6.40	7.00	10	5.0	800 / 1600	9.2	43.5
SMAJ6.0A	HG	SMAJ6.0CA	TG	6.67	7.37	10	6.0	800 / 1600	10.3	38.8
SMAJ6.5A	HK	SMAJ6.5CA	TK	7.22	7.98	10	6.5	500 / 1000	11.2	35.7
SMAJ7.0A	HM	SMAJ7.0CA	TM	7.78	8.60	10	7.0	200 / 400	12.0	33.3
SMAJ7.5A	HP	SMAJ7.5CA	TP	8.33	9.21	1.0	7.5	100 / 200	12.9	31.0
SMAJ8.0A	HR	SMAJ8.0CA	TR	8.89	9.83	1.0	8.0	50 / 100	13.6	29.4
SMAJ8.5A	HT	SMAJ8.5CA	TT	9.44	10.4	1.0	8.5	10 / 20	14.4	27.7
SMAJ9.0A	HV	SMAJ9.0CA	TV	10.0	11.1	1.0	9.0	5 / 10	15.4	26.0
SMAJ10A	HX	SMAJ10CA	TX	11.1	12.3	1.0	10	5 / 10	17.0	23.5
SMAJ11A	HZ	SMAJ11CA	TZ	12.2	13.2	1.0	11	5.0	18.2	22.0
SMAJ12A	IE	SMAJ12CA	UE	13.3	14.7	1.0	12	5.0	19.9	20.1
SMAJ13A	IG	SMAJ13CA	UG	14.4	15.9	1.0	13	5.0	21.5	18.6
SMAJ14A	IK	SMAJ14CA	UK	15.6	17.2	1.0	14	5.0	23.2	17.2
SMAJ15A	IM	SMAJ15CA	UM	16.7	18.5	1.0	15	5.0	24.4	16.4
SMAJ16A	IP	SMAJ16CA	UP	17.8	19.7	1.0	16	5.0	26.0	15.3
SMAJ17A	IR	SMAJ17CA	UR	18.9	20.9	1.0	17	5.0	27.6	14.5
SMAJ18A	IT	SMAJ18CA	UT	20.0	22.1	1.0	18	5.0	29.2	13.7
SMAJ20A	IV	SMAJ20CA	UV	22.2	24.5	1.0	20	5.0	32.4	12.3
SMAJ22A	IX	SMAJ22CA	UX	24.4	26.9	1.0	22	5.0	35.5	11.2
SMAJ24A	IZ	SMAJ24CA	UZ	26.7	29.5	1.0	24	5.0	38.9	10.3
SMAJ26A	JE	SMAJ26CA	VE	28.9	31.9	1.0	26	5.0	42.1	9.5
SMAJ28A	JG	SMAJ28CA	VG	31.1	34.4	1.0	28	5.0	45.4	8.8
SMAJ30A	JK	SMAJ30CA	VK	33.3	36.8	1.0	30	5.0	48.4	8.3
SMAJ33A	JM	SMAJ33CA	VM	36.7	40.6	1.0	33	5.0	53.3	7.5
SMAJ36A	JP	SMAJ36CA	VP	40	44.2	1.0	36	5.0	58.1	6.9
SMAJ40A	JR	SMAJ40CA	VR	44.4	49.1	1.0	40	5.0	64.5	6.2
SMAJ43A	JT	SMAJ43CA	VT	47.8	52.8	1.0	43	5.0	69.4	5.7
SMAJ45A	JV	SMAJ45CA	VV	50	55.3	1.0	45	5.0	72.7	5.5
SMAJ48A	JX	SMAJ48CA	VX	53.3	58.9	1.0	48	5.0	77.4	5.2
SMAJ51A	JZ	SMAJ51CA	VZ	56.7	62.7	1.0	51	5.0	82.4	4.9
SMAJ54A	RE	SMAJ54CA	WE	60	66.3	1.0	54	5.0	87.1	4.6
SMAJ58A	RG	SMAJ58CA	WG	64.4	71.2	1.0	58	5.0	93.6	4.3
SMAJ60A	RK	SMAJ60CA	WK	66.7	73.7	1.0	60	5.0	96.8	4.1
SMAJ64A	RM	SMAJ64CA	WM	71.1	78.6	1.0	64	5.0	103	3.9
SMAJ70A	RP	SMAJ70CA	WP	77.8	86.0	1.0	70	5.0	113	3.5
SMAJ75A	RR	SMAJ75CA	WR	83.3	92.1	1.0	75	5.0	121	3.3
SMAJ78A	RT	SMAJ78CA	WT	86.7	95.8	1.0	78	5.0	126	3.2
SMAJ85A	RV	SMAJ85CA	VV	94.4	104	1.0	85	5.0	137	2.9
SMAJ90A	RX	SMAJ90CA	WX	100	111	1.0	90	5.0	146	2.7
SMAJ100A	RZ	SMAJ100CA	WZ	111	123	1.0	100	5.0	162	2.5
SMAJ110A	SE	SMAJ110CA	XE	122	135	1.0	110	5.0	177	2.3
SMAJ120A	SG	SMAJ120CA	XG	133	147	1.0	120	5.0	193	2.0
SMAJ130A	SK	SMAJ130CA	XK	144	159	1.0	130	5.0	209	1.9
SMAJ150A	SM	SMAJ150CA	XM	167	185	1.0	150	5.0	243	1.6
SMAJ160A	SP	SMAJ160CA	XP	178	197	1.0	160	5.0	259	1.5
SMAJ170A	SR	SMAJ170CA	XR	189	209	1.0	170	5.0	275	1.4

Notes:

- Suffix 'A' denotes a 5 % tolerance unidirectional device.
- Suffix 'CA' denotes a 5 % tolerance bidirectional device.
- For bidirectional devices with a V_R of 10 volts or less, the I_R limit is double.
- For unidirectional devices with a V_F max. of 3.5 V at an I_F of 35 A, 0.5 Sine Wave of 8.3 ms Pulse Width.

Specifications are subject to change without notice.
Customers should verify actual device performance in their specific applications.

SMAJ Transient Voltage Suppressor Diode Series

BOURNS®

Product Dimensions

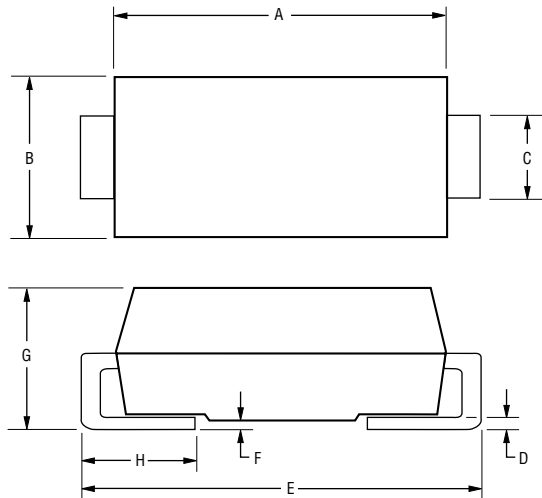

Dimension	SMA (DO-214AC)
A	$\frac{4.06 - 4.57}{(0.160 - 0.180)}$
B	$\frac{2.29 - 2.92}{(0.090 - 0.115)}$
C	$\frac{1.27 - 1.63}{(0.050 - 0.064)}$
D	$\frac{0.15 - 0.31}{(0.006 - 0.112)}$
E	$\frac{4.83 - 5.59}{(0.190 - 0.220)}$
F	$\frac{0.05 - 0.20}{(0.002 - 0.008)}$
G	$\frac{2.01 - 2.62}{(0.080 - 0.103)}$
H	$\frac{0.76 - 1.52}{(0.030 - 0.060)}$

DIMENSIONS: $\frac{\text{MM}}{(\text{INCHES})}$

Recommended Footprint

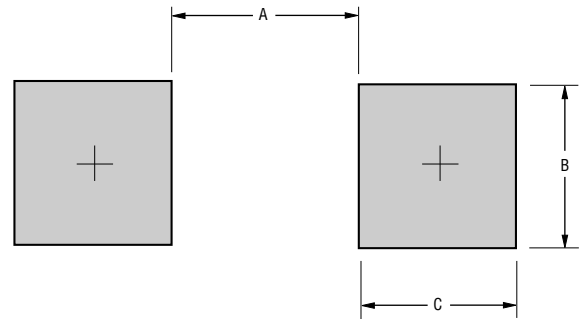

Dimension	SMA (DO-214AC)
A (Max.)	$\frac{2.70}{(0.106)}$
B (Min.)	$\frac{2.10}{(0.083)}$
C (Min.)	$\frac{1.27}{(0.050)}$

DIMENSIONS: $\frac{\text{MM}}{(\text{INCHES})}$

Physical Specifications

CaseMolded plastic per UL Class 94V-0
 Polarity Cathode band indicates unidirectional device
 No cathode band indicates bidirectional device
 Weight0.002 ounces / 0.064 grams

SMAJ Transient Voltage Suppressor Diode Series

BOURNS®

Rating & Characteristic Curves

Pulse Derating Curve

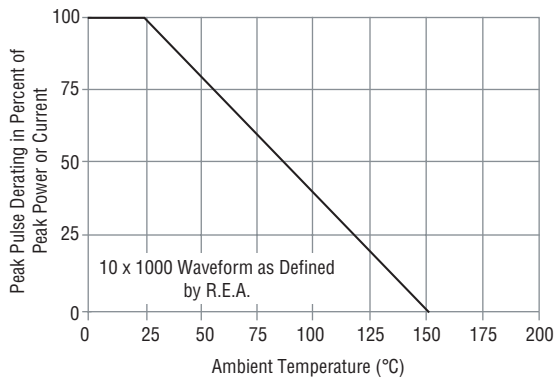

Maximum Non-Repetitive Surge Current

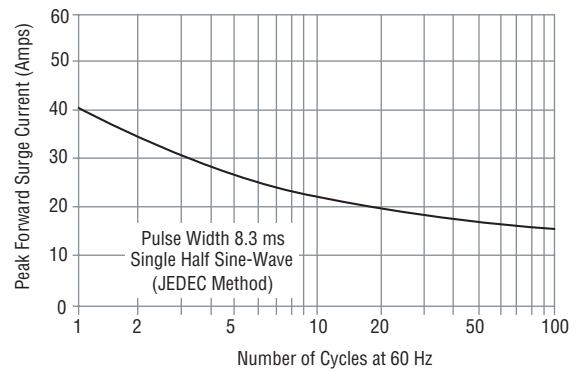

Pulse Waveform

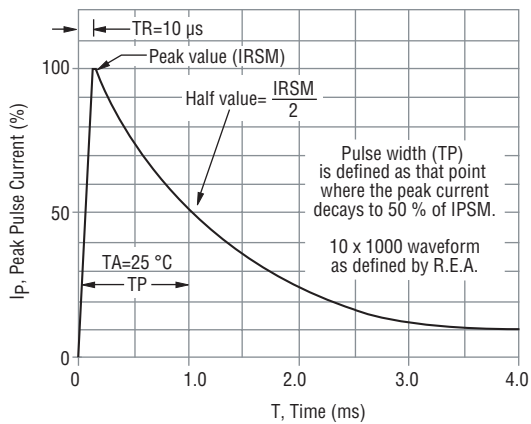

Typical Junction Capacitance

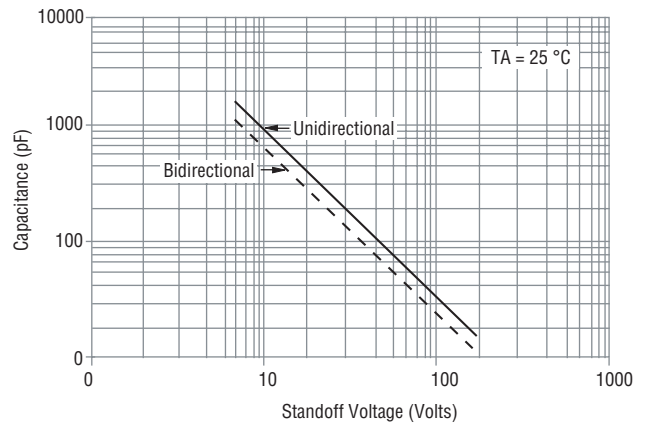

Pulse Rating Curve

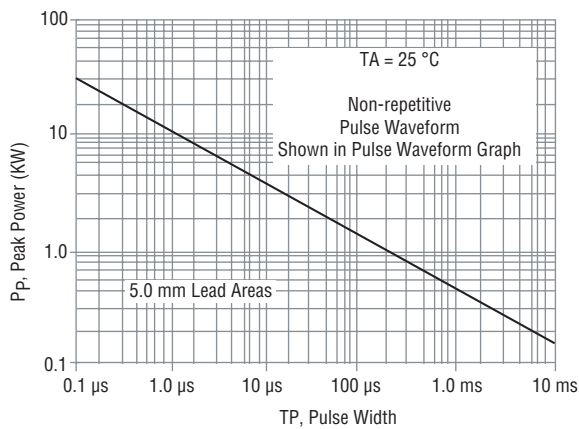

Steady State Power Derating Curve

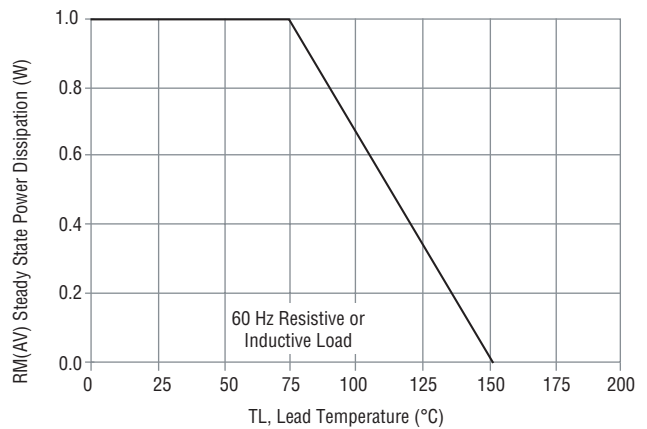

Specifications are subject to change without notice.
Customers should verify actual device performance in their specific applications.

SMAJ Transient Voltage Suppressor Diode Series

BOURNS®

Packaging Information

The product will be dispensed in tape and reel format (see diagram below).

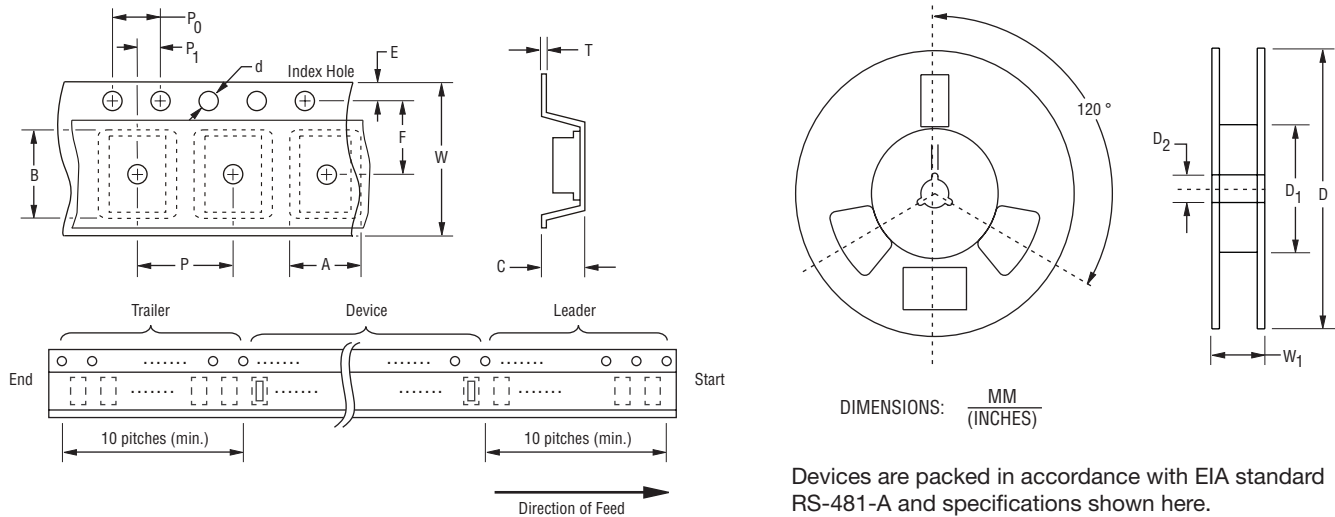

Item	Symbol	SMA (DO-214AC)
Carrier Width	A	2.90 ± 0.10 (0.114 ± 0.004)
Carrier Length	B	5.59 ± 0.10 (0.220 ± 0.004)
Carrier Depth	C	2.36 ± 0.10 (0.093 ± 0.004)
Sprocket Hole	d	1.55 ± 0.05 (0.061 ± 0.002)
Reel Outside Diameter	D	330 (12.992)
Reel Inner Diameter	D ₁	50.0 (1.969) MIN.
Feed Hole Diameter	D ₂	13.0 ± 0.20 (0.512 ± 0.008)
Sprocket Hole Position	E	1.75 ± 0.10 (0.069 ± 0.004)
Punch Hole Position	F	5.50 ± 0.05 (0.217 ± 0.002)
Punch Hole Pitch	P	4.00 ± 0.10 (0.157 ± 0.004)
Sprocket Hole Pitch	P ₀	4.00 ± 0.10 (0.157 ± 0.004)
Embossment Center	P ₁	2.00 ± 0.05 (0.079 ± 0.002)
Overall Tape Thickness	T	0.30 ± 0.10 (0.012 ± 0.004)
Tape Width	W	12.00 ± 0.20 (0.472 ± 0.008)
Reel Width	W ₁	18.4 (0.724) MAX.
Quantity per Reel	--	5,000

02/10

Specifications are subject to change without notice.
Customers should verify actual device performance in their specific applications.