

KEMET's High Voltage Surface Mount Capacitors are designed to withstand high voltage applications. They offer high capacitance with low leakage current and low ESR at high frequency. The capacitors have pure tin (Sn) plated external electrodes for good solderability. X7R dielectrics are not designed for AC line filtering applications. An insulating coating may be required to prevent surface arcing. These components are RoHS compliant.

APPLICATIONS

- Switch Mode Power Supply
 - Input Filter
 - Resonators
 - Tank Circuit
 - Snubber Circuit
 - Output Filter
- High Voltage Coupling
- High Voltage DC Blocking
- Lighting Ballast
- Voltage Multiplier Circuits
- Coupling Capacitor/CUK

MARKETS

- Power Supply
- High Voltage Power Supply
- DC-DC Converter
- LCD Fluorescent Backlight Ballast
- HID Lighting
- Telecommunications Equipment
- Industrial Equipment/Control
- Medical Equipment/Control
- Computer (LAN/WAN Interface)
- Analog and Digital Modems
- Automotive

OUTLINE DRAWING

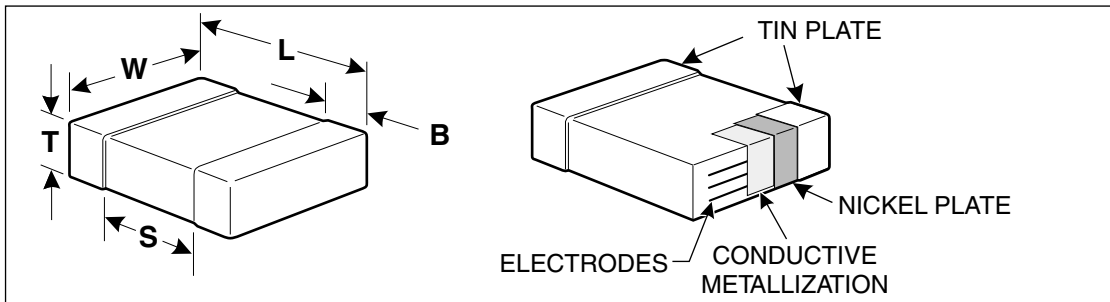

TABLE 1 - DIMENSIONS - MILLIMETERS (in.)

Metric Code	EIA Size Code	L - Length	W - Width	B - Bandwidth	Band Separation
2012	0805	2.0 (0.079) ± 0.2 (0.008)	1.2 (0.049) ± 0.2 (0.008)	0.5 (0.02) ±0.25 (0.010)	0.75 (0.030)
3216	1206	3.2 (0.126) ± 0.2 (0.008)	1.6 (0.063) ± 0.2 (0.008)	0.5 (0.02) ± 0.25 (0.010)	N/A
3225	1210	3.2 (0.126) ± 0.2 (0.008)	2.5 (0.098) ± 0.2 (0.008)	0.5 (0.02) ± 0.25 (0.010)	N/A
4520	1808	4.5 (0.177) ± 0.3 (0.012)	2.0 (0.079) ± 0.2 (0.008)	0.6 (0.024) ± 0.35 (0.014)	N/A
4532	1812	4.5 (0.177) ± 0.3 (0.012)	3.2 (0.126) ± 0.3 (0.012)	0.6 (0.024) ± 0.35 (0.014)	N/A
4564	1825	4.5 (0.177) ± 0.3 (0.012)	6.4 (0.250) ± 0.4 (0.016)	0.6 (0.024) ± 0.35 (0.014)	N/A
5650	2220	5.6 (0.224) ± 0.4 (0.016)	5.0 (0.197) ± 0.4 (0.016)	0.6 (0.024) ± 0.35 (0.014)	N/A
5664	2225	5.6 (0.224) ± 0.4 (0.016)	6.4 (0.250) ± 0.4 (0.016)	0.6 (0.024) ± 0.35 (0.014)	N/A

Ceramic Surface Mount

C0G DIELECTRIC CAPACITANCE VALUES AND THICKNESS TARGETS (mm)

Table with columns for Cap pF, Cap Tol., Series, and various voltage ratings (0805, 1206, 1210, 1808, 1812, 1825, 2220, 2225) and their corresponding capacitance and tolerance values.

* Contact KEMET Sales Representative for C, D, F & G Capacitance Tolerance availability.
Note: Actual thickness dimensions may be less than stated maximum. Check the KEMET website, www.kemet.com, for additional values and chip sizes available.

CAPACITOR ORDERING INFORMATION

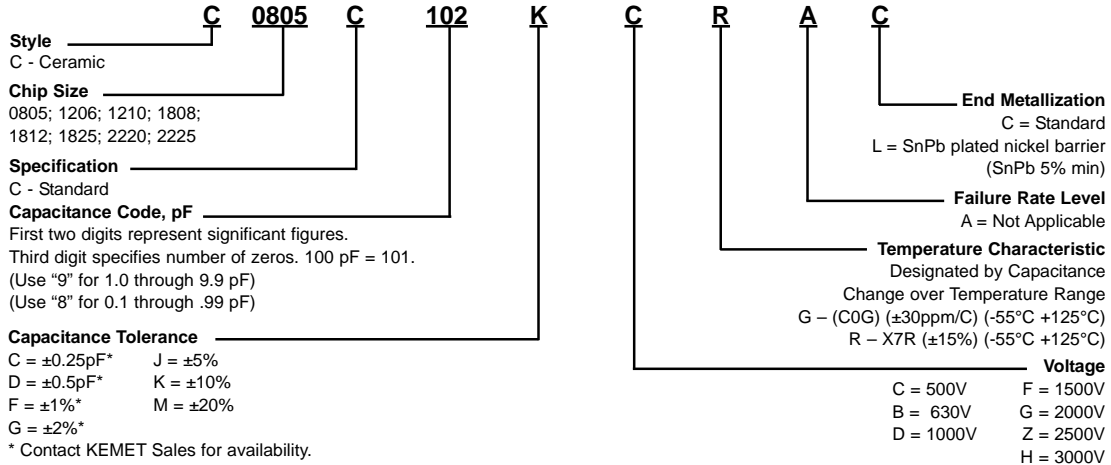

ELECTRICAL PARAMETERS

Property	Specification
Capacitance	C0G: 1 pF to 0.010 μF X7R: 10 pF to 0.22 μF 25°C, 1.0 ± 0.2 Vrms, 1 kHz (1 MHz for ≤ 1000 pF (C0G only))
Cap Tolerance	C0G: C*, D*, F*, G*, J, K, M * Contact KEMET Sales for availability. X7R: J, K, M
DF	C0G: 0.1% Max X7R: 2.5% Max
Voltage Ratings	500 V, 1000 V, 1500 V, 2000 V, 2500 V, 3000 V
Operating Temperature Range	From -55°C to +125°C
25°C IR @ 500V	100 GΩ or 1000 MΩ-μF, whichever is less
125°C IR @ 500V	10 GΩ or 100 MΩ-μF, whichever is less
-55°C TCC +125°C TCC	X7R: ± 15% C0G: ± 30 ppm / °C
Dielectric Strength	150% of Rated Voltage for Rated Voltage <1000 V 120% of Rated Voltage for Rated Voltage ≥1000V
Ripple Current	Consult KEMET Sales Representative

MARKING

These chips are supplied unmarked. If required, they can be supplied LASER-marked at an extra cost. Details on the marking format is located on page 97.

PACKAGING

KEMET High Voltage Surface Mount MLCC are available packaged in tape and reel configuration, or bulk bag as outlined on page 83. Please consult factory for waffle packaging options.

SOLDERING PROCESS

The 0805 and 1206 case sizes are suitable for either reflow or wave soldering processes. Sizes 1210 and larger should be limited to reflow soldering only. All sizes incorporate the standard KEMET barrier layer of pure nickel with an overplating of pure tin (Sn) for excellent solderability and resistance to solder leaching of the termination.

RECOMMENDED SOLDER PAD DIMENSIONS

Chip Size	T (Total Length)		S (Separation)		W (Pad Width)		L (Pad Length)	
	mm	in.	mm	in.	mm	in.	mm	in.
0805	3.30	0.130	0.70	0.028	1.60	0.063	1.30	0.051
1206	4.50	0.177	1.50	0.059	2.00	0.079	1.50	0.059
1210	4.50	0.177	1.50	0.059	2.90	0.114	1.50	0.059
1808	5.90	0.232	2.30	0.091	2.40	0.094	1.80	0.071
1812	5.90	0.232	2.30	0.091	3.70	0.146	1.80	0.071
1825	5.90	0.232	2.30	0.091	6.90	0.272	1.80	0.071
2220	7.00	0.276	3.30	0.130	5.50	0.217	1.85	0.073
2225	7.00	0.276	3.30	0.130	6.80	0.268	1.85	0.073

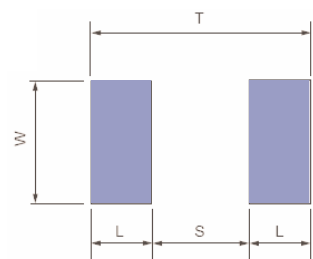

Thickness Code Reference Chart Packaging Quantity Based on Finished Chip Thickness Specifications

Thickness Code	Chip Size	Chip Thickness Range (mm)	Qty per Reel 7" Plastic	Qty per Reel 13" Plastic	Qty per Reel 7" Paper	Qty per Reel 13" Paper	Qty per Bulk Cassette
AA	0201	0.30 ± 0.03	N/A	N/A	15,000	N/A	N/A
BB	0402	0.50 ± 0.05	N/A	N/A	10,000	50,000	50,000
CB	0603	0.80 ± 0.07	N/A	N/A	4,000	10,000	15,000
CC	0603	0.80 ± 0.10	N/A	N/A	4,000	10,000	N/A
CD	0603	0.80 ± 0.15	N/A	N/A	4,000	10,000	N/A
DB	0805	0.60 ± 0.10	N/A	N/A	4,000	10,000	10,000
DC	0805	0.78 ± 0.10	N/A	N/A	4,000	10,000	N/A
DD	0805	0.90 ± 0.10	N/A	N/A	4,000	10,000	N/A
DE	0805	1.00 ± 0.10	2,500	10,000	N/A	N/A	N/A
DF	0805	1.10 ± 0.10	2,500	10,000	N/A	N/A	N/A
DG	0805	1.25 ± 0.15	2,500	10,000	N/A	N/A	N/A
DH	0805	1.25 ± 0.20	2,500	10,000	N/A	N/A	N/A
DJ	0805	1.25 ± 0.20	3,000	N/A	N/A	N/A	N/A
DK	0805	1.25 ± 0.15	3,000	N/A	N/A	N/A	N/A
DL	0805	0.95 ± 0.10	4,000	10,000	N/A	N/A	N/A
EB	1206	0.78 ± 0.10	4,000	10,000	4,000	10,000	N/A
EC	1206	0.90 ± 0.10	4,000	10,000	N/A	N/A	N/A
ED	1206	1.00 ± 0.10	2,500	10,000	N/A	N/A	N/A
EE	1206	1.10 ± 0.10	2,500	10,000	N/A	N/A	N/A
EF	1206	1.20 ± 0.15	2,500	10,000	N/A	N/A	N/A
EG	1206	1.60 ± 0.15	2,000	8,000	N/A	N/A	N/A
EH	1206	1.60 ± 0.20	2,000	8,000	N/A	N/A	N/A
EJ	1206	1.70 ± 0.20	2,000	8,000	N/A	N/A	N/A
EK	1206	0.80 ± 0.10	2,000	8,000	N/A	N/A	N/A
EL	1206	1.15 ± 0.15	2,000	8,000	N/A	N/A	N/A
EM	1206	1.25 ± 0.15	2,500	10,000	N/A	N/A	N/A
EN	1206	0.95 ± 0.10	4,000	10,000	N/A	N/A	N/A
FB	1210	0.78 ± 0.10	4,000	10,000	N/A	N/A	N/A
FC	1210	0.90 ± 0.10	4,000	10,000	N/A	N/A	N/A
FD	1210	0.95 ± 0.10	4,000	10,000	N/A	N/A	N/A
FE	1210	1.00 ± 0.10	2,500	10,000	N/A	N/A	N/A
FF	1210	1.10 ± 0.10	2,500	10,000	N/A	N/A	N/A
FG	1210	1.25 ± 0.15	2,500	10,000	N/A	N/A	N/A
FH	1210	1.55 ± 0.15	2,000	8,000	N/A	N/A	N/A
FJ	1210	1.85 ± 0.20	2,000	8,000	N/A	N/A	N/A
FK	1210	2.10 ± 0.20	2,000	8,000	N/A	N/A	N/A
FL	1210	1.40 ± 0.15	2,000	8,000	N/A	N/A	N/A
FM	1210	1.70 ± 0.20	2,000	8,000	N/A	N/A	N/A
FN	1210	1.85 ± 0.20	2,000	8,000	N/A	N/A	N/A
FO	1210	1.50 ± 0.20	2,000	8,000	N/A	N/A	N/A
FP	1210	1.60 ± 0.20	2,000	8,000	N/A	N/A	N/A
FQ	1210	2.50 ± 0.22	1,500	N/A	N/A	N/A	N/A
FR	1210	2.25 ± 0.20	2,000	8,000	N/A	N/A	N/A
FS	1210	2.50 ± 0.20	1,000	4,000	N/A	N/A	N/A
FT	1210	1.90 ± 0.20	1,500	4,000	N/A	N/A	N/A
LD	1808	0.90 ± 0.10	4,000	10,000	N/A	N/A	N/A
GB	1812	1.00 ± 0.10	1,000	4,000	N/A	N/A	N/A
GC	1812	1.10 ± 0.10	1,000	4,000	N/A	N/A	N/A
GD	1812	1.25 ± 0.15	1,000	4,000	N/A	N/A	N/A
GE	1812	1.30 ± 0.10	1,000	4,000	N/A	N/A	N/A
GF	1812	1.50 ± 0.10	1,000	4,000	N/A	N/A	N/A
GG	1812	1.55 ± 0.10	1,000	4,000	N/A	N/A	N/A
GH	1812	1.40 ± 0.15	1,000	4,000	N/A	N/A	N/A
GJ	1812	1.70 ± 0.15	1,000	4,000	N/A	N/A	N/A
GK	1812	1.60 ± 0.20	1,000	4,000	N/A	N/A	N/A
GL	1812	1.90 ± 0.20	1,000	4,000	N/A	N/A	N/A
GM	1812	2.00 ± 0.20	1,000	4,000	N/A	N/A	N/A
GN	1812	1.70 ± 0.20	1,000	4,000	N/A	N/A	N/A
GO	1812	2.50 ± 0.20	500	N/A	N/A	N/A	N/A
HB	1825	1.10 ± 0.15	1,000	4,000	N/A	N/A	N/A
HC	1825	1.15 ± 0.15	1,000	4,000	N/A	N/A	N/A
HD	1825	1.30 ± 0.15	1,000	4,000	N/A	N/A	N/A
HE	1825	1.40 ± 0.15	1,000	4,000	N/A	N/A	N/A
HF	1825	1.50 ± 0.15	1,000	4,000	N/A	N/A	N/A
JB	2220	1.00 ± 0.15	1,000	4,000	N/A	N/A	N/A
JC	2220	1.10 ± 0.15	1,000	4,000	N/A	N/A	N/A
JD	2220	1.30 ± 0.15	1,000	4,000	N/A	N/A	N/A
JE	2220	1.40 ± 0.15	1,000	4,000	N/A	N/A	N/A
JF	2220	1.50 ± 0.15	1,000	4,000	N/A	N/A	N/A
JG	2220	1.70 ± 0.15	1,000	4,000	N/A	N/A	N/A
JH	2220	1.80 ± 0.15	1,000	4,000	N/A	N/A	N/A
JO	2220	2.40 ± 0.15	500	2,000	N/A	N/A	N/A
KB	2225	1.00 ± 0.15	1,000	4,000	N/A	N/A	N/A
KC	2225	1.10 ± 0.15	1,000	4,000	N/A	N/A	N/A
KD	2225	1.30 ± 0.15	1,000	4,000	N/A	N/A	N/A
KE	2225	1.40 ± 0.15	1,000	4,000	N/A	N/A	N/A

This chart refers to ceramic chip thickness codes on pages 73 – 76.

Note: TU suffix represents tape and reel packaging of unmarked components.

Note: TM suffix represents tape and reel packaging of marked components.

Cases sizes ≤1210 are 8mm tape with 4mm pitch and Case Sizes >1210 are 12mm tape and 8mm pitch.

Tape & Reel Packaging

KEMET offers Multilayer Ceramic Chip Capacitors packaged in 8mm and 12mm plastic tape on 7" and 13" reels in accordance with EIA standard 481-1: Taping of surface mount components for automatic handling. This packaging system is compatible with all tape fed automatic pick and place systems. See page 78 for details on reeling quantities for commercial chips and page 87 for MIL-PRF-55681 chips.

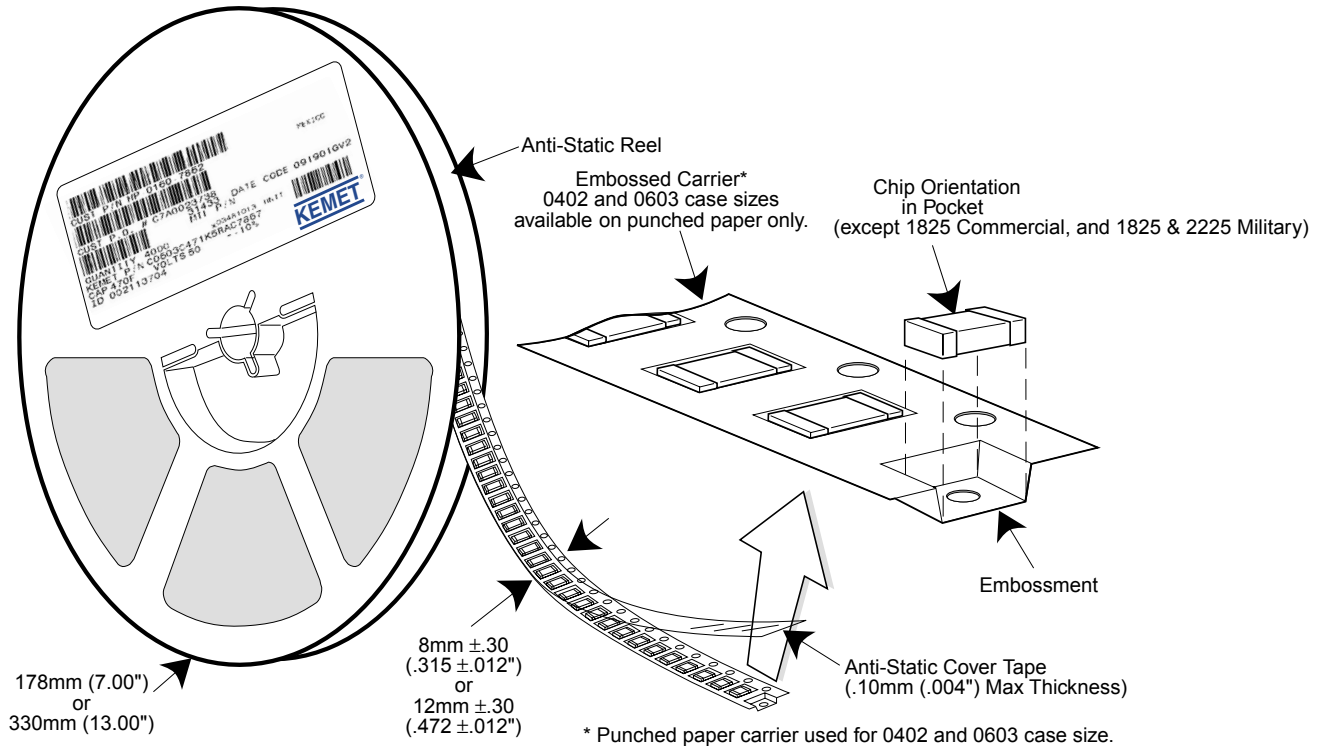

Case Sizes ≤ 1210 are 8 mm tape with 4 mm pitch.
Case Sizes >1210 are 12 mm tape with 8 mm pitch.

Note: TU suffix represents tape and reel packaging of unmarked components.
TM suffix represents tape and reel packaging of marked components.

SURFACE MOUNT LAND DIMENSIONS - CERAMIC CHIP CAPACITORS - MM

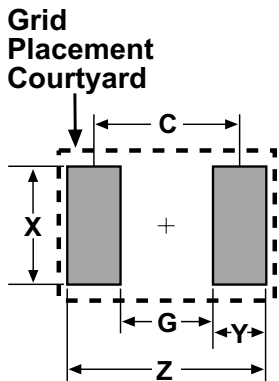

Dimension	Reflow Solder					Wave Solder				
	Z	G	X	Y(ref)	C(ref)	Z	G	X	Y(ref)	Smin
0402	2.14	0.28	0.74	0.93	1.21	Not Recommended				
0603	2.78	0.68	1.08	1.05	1.73	3.18	0.68	0.80	1.25	1.93
0805	3.30	0.70	1.60	1.30	2.00	3.70	0.70	1.10	1.50	2.20
1206	4.50	1.50	2.00	1.50	3.00	4.90	1.50	1.40	1.70	3.20
1210	4.50	1.50	2.90	1.50	3.00	4.90	1.50	2.00	1.70	3.20
1812	5.90	2.30	3.70	1.80	4.10	Not Recommended				
1825	5.90	2.30	6.90	1.80	4.10					
2220	7.00	3.30	5.50	1.85	5.15					
2225	7.00	3.30	6.80	1.85	5.15					

Calculation Formula
 $Z = Lmin + 2Jt + Tt$
 $G = Smax - 2Jh - Th$
 $X = Wmin + 2Js + Ts$
 Tt, Th, Ts = Combined tolerances

TANTALUM, CERAMIC AND ALUMINUM CHIP CAPACITORS

Packaging Information

Performance Notes

- Cover Tape Break Force:** 1.0 Kg Minimum.
- Cover Tape Peel Strength:** The total peel strength of the cover tape from the carrier tape shall be:

Tape Width	Peel Strength
8 mm	0.1 Newton to 1.0 Newton (10g to 100g)
12 mm	0.1 Newton to 1.3 Newton (10g to 130g)

The direction of the pull shall be opposite the direction of the carrier tape travel. The pull angle of the carrier tape shall be 165° to 180° from the plane of the carrier tape. During peeling, the carrier and/or cover tape shall be pulled at a velocity of 300 ±10 mm/minute.

- Reel Sizes:** Molded tantalum capacitors are available on either 180 mm (7") reels (standard) or 330 mm (13") reels (with C-7280). Note that 13" reels are preferred.
- Labeling:** Bar code labeling (standard or custom) shall be on the side of the reel opposite the sprocket holes. Refer to EIA-556.

Embossed Carrier Tape Configuration: Figure 1

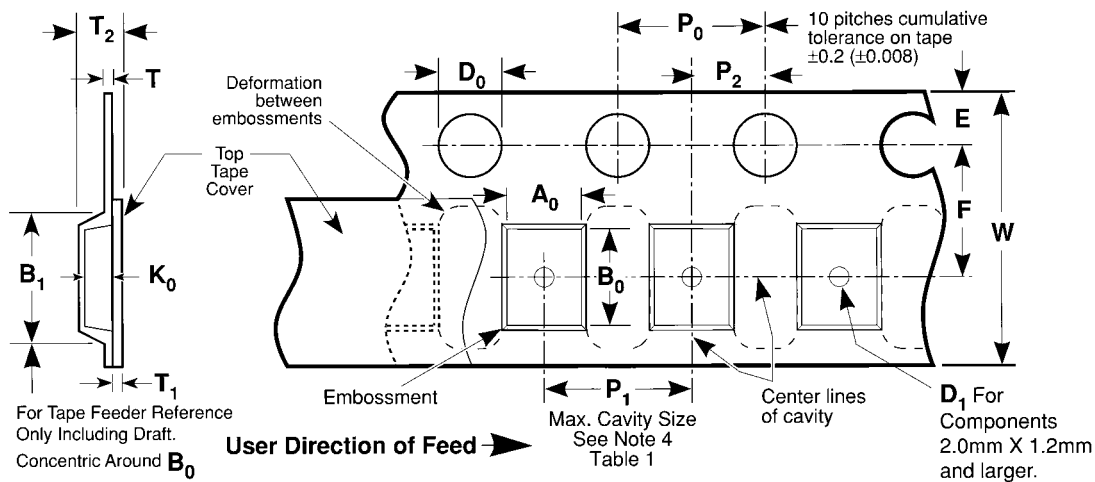

Table 1 — EMBOSSED TAPE DIMENSIONS (Metric will govern)

Constant Dimensions — Millimeters (Inches)									
Tape Size	D ₀	E	P ₀	P ₂	T Max	T ₁ Max			
8 mm and 12 mm	1.5 +0.10 -0.0 (0.059 +0.004, -0.0)	1.75 ±0.10 (0.069 ±0.004)	4.0 ±0.10 (0.157 ±0.004)	2.0 ±0.05 (0.079 ±0.002)	0.600 (0.024)	0.100 (0.004)			
Variable Dimensions — Millimeters (Inches)									
Tape Size	Pitch	B ₁ Max. Note 1	D ₁ Min. Note 2	F	P ₁	R Min. Note 3	T ₂ Max	W	A ₀ B ₀ K ₀ Note 4
8 mm	Single (4 mm)	4.4 (0.173)	1.0 (0.039)	3.5 ±0.05 (0.138 ±0.002)	4.0 ±0.10 (0.157 ±0.004)	25.0 (0.984)	2.5 (0.098)	8.0 ±0.30 (.315 ±0.012)	
12 mm	Double (8 mm)	8.2 (0.323)	1.5 (0.059)	5.5 ±0.05 (0.217 ±0.002)	8.0 ±0.10 (0.315 ±0.004)	30.0 (1.181)	4.6 (0.181)	12.0 ±0.30 (0.472 ±0.012)	

NOTES

- B1 dimension is a reference dimension for tape feeder clearance only.
- The embossment hole location shall be measured from the sprocket hole controlling the location of the embossment. Dimensions of embossment location and hole location shall be applied independent of each other.
- Tape with components shall pass around radius "R" without damage (see sketch A). The minimum trailer length (Fig. 2) may require additional length to provide R min. for 12 mm embossed tape for reels with hub diameters approaching N min. (Table 2)
- The cavity defined by A₀, B₀, and K₀ shall be configured to surround the part with sufficient clearance such that the chip does not protrude beyond the sealing plane of the cover tape, the chip can be removed from the cavity in a vertical direction without mechanical restriction, rotation of the chip is limited to 20 degrees maximum in all 3 planes, and lateral movement of the chip is restricted to 0.5 mm maximum in the pocket (not applicable to vertical clearance.)

Embossed Carrier Tape Configuration (cont.)

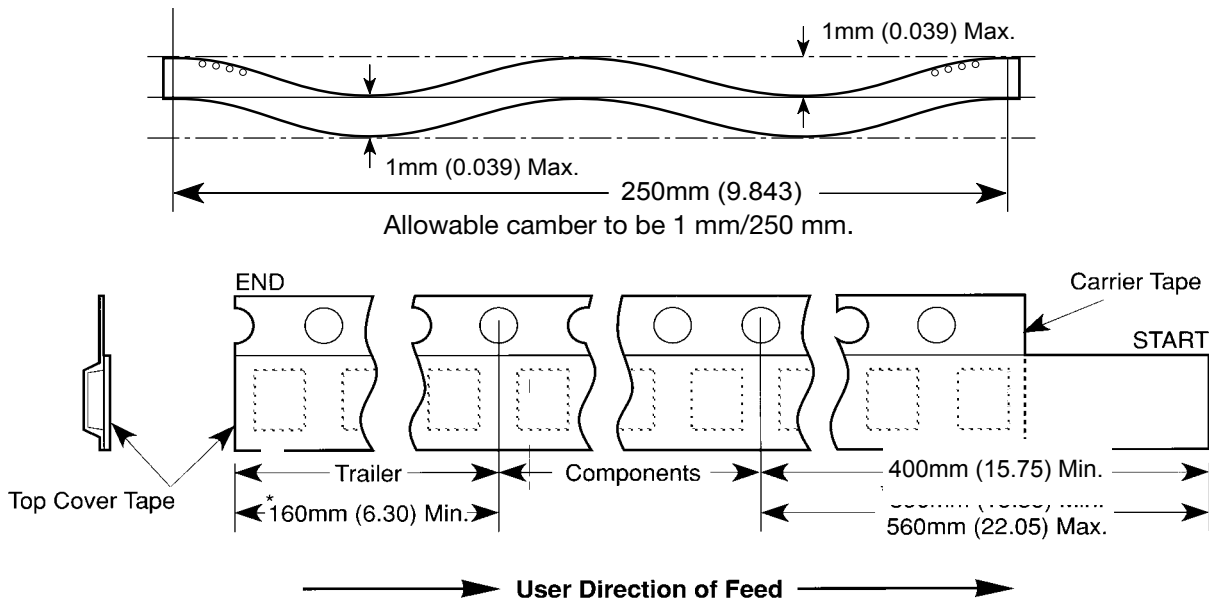
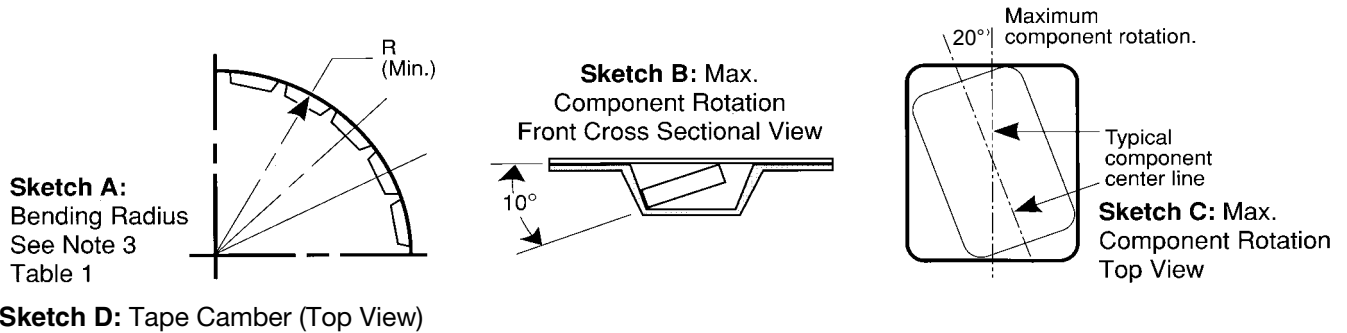

Figure 2:
Tape Leader
& Trailer
Dimensions
(Metric
Dimensions
Will Govern)

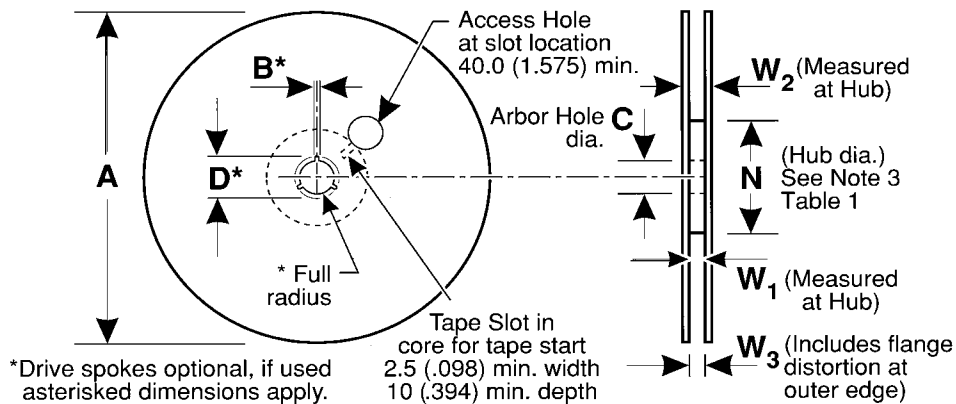

Figure 3: Reel Dimensions (Metric Dimensions will govern)

Table 2 – REEL DIMENSIONS (Metric will govern)

Tape Size	A Max	B* Min	C	D* Min	N Min	W_1	W_2 Max	W_3
8 mm	330.0 (12.992)	1.5 (0.059)	13.0 ± 0.20 (0.512 ± 0.008)	20.2 (0.795)	50.0 (1.969) See Note 3	8.4 +1.5, -0.0 (0.331 +0.059, -0.0)	14.4 (0.567)	7.9 Min (0.311) 10.9 Max (0.429)
12 mm	330.0 (12.992)	1.5 (0.059)	13.0 ± 0.20 (0.512 ± 0.008)	20.2 (0.795)	Table 1	12.4 +2.0, -0.0 (0.488 +0.078, -0.0)	18.4 (0.724)	11.9 Min (0.469) 15.4 Max (0.606)

Punched Carrier (Paper Tape) Configuration (Ceramic Chips Only):

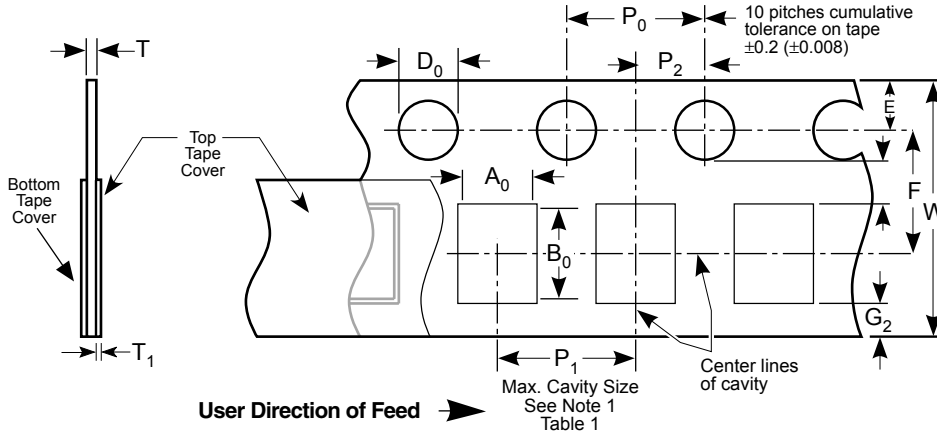

Table 1: 8 & 12mm Punched Tape
(Metric Dimensions Will Govern)

Constant Dimensions - Millimeters (Inches)

Tape Size	D ₀	E	P ₀	P ₂	T ₁	G ₁	G ₂	R Min.
8mm and 12mm	1.5 +0.10, -0.0 (.059 +0.004, -0.0)	1.75 ± 0.10 (.069 ± 0.004)	4.0 ± 0.10 (.157 ± 0.004)	2.0 ± 0.05 (.079 ± 0.002)	0.10 (.004) Max.	0.75 (.030) Min.	0.75 (.030) Min.	25 (.984) See Note 2 Table 1

Table 1: 8 & 12mm Punched Tape
(Metric Dimensions Will Govern)

Variable Dimensions - Millimeters (Inches)

Tape Size	P ₁	F	W	A ₀ B ₀	T
8mm 1/2 Pitch	2.0 ± 0.10 (.079 ± .004) See Requirements Section 3.3 (d)	3.5 ± 0.05 (.138 ± .002)	8.0 ± 0.3 (.315 ± 0.012)	See Note 1 Table 1	1.1mm (.043) Max. for Paper Base Tape and 1.6mm (.063) Max. for Non- Paper Base Compositions. See Note 3.
8mm	4.0 ± 0.10 (0.157 ± .004)				
12mm	4.0 ± 0.10 (0.157 ± .004)				
12mm Double Pitch	8.0 ± 0.10 (0.315 ± .004)	5.5 ± 0.05 (.217 ± .002)	12.0 ± 0.3 (.472 ± .012)		

Note:

- A₀, B₀ and T determined by the maximum dimensions to the ends of the terminals extending from the body and/or the body dimensions of the component. The clearance between the ends of the terminals or body of the component to the sides and depth of the cavity (A₀, B₀ and T) must be within 0.05mm (.002) minimum and 0.50mm (.020) maximum. The clearance allowed must also prevent rotation of the component within the cavity of not more than 20 degrees (see sketches A and B).
- Tape with components shall pass around radius "R" without damage.
- KEMET nominal thicknesses are: 0402 = 0.6mm and all others 0.95mm minimum.

Sketch A:
Bending Radius
See Note 2
Table 1

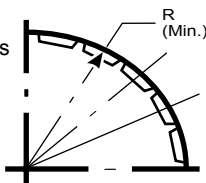

Sketch B:
Max. Component
Rotation - Front
Cross Sectional View

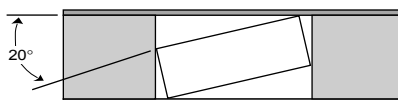

Sketch C:
Component Rotation - Top View

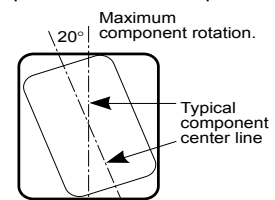

Bulk Cassette Packaging (Ceramic Chips only) (Meets Dimensional Requirements IEC-286-6 and EIAJ 7201)

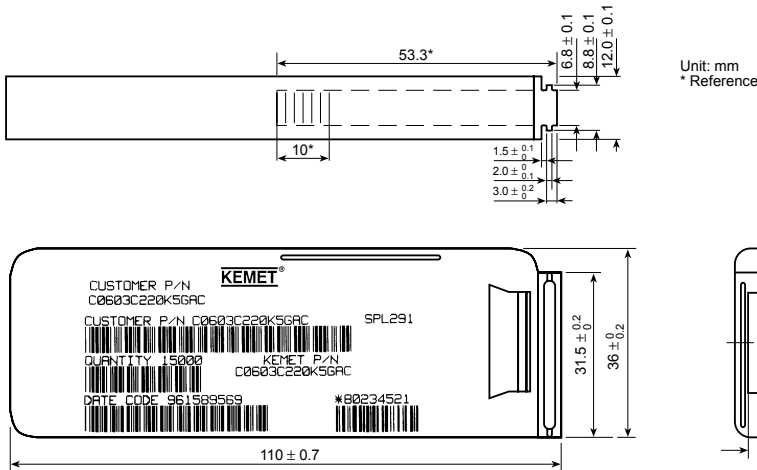

Table 2 – Capacitance Values Available In Bulk Cassette Packaging

Case Size	Dielectric	Voltage	Min. Cap Value	Max. Cap Value
0402	All	All	All	All
0603	All	All	All	All
0805	C0G	200	109	181
		100	109	331
		50	109	102
	X7R	200	221	392
		100	221	103
		50	221	273
		25	221	104
		16	221	104
Y5V		25	104	224
		16	104	224

Table 1 – Capacitor Dimensions for Bulk Cassette Packaging – Millimeters

Metric Size Code	EIA Size Code	Length L	Width W	Thickness T	Bandwidth B	Minimum Separation S	Number of Pcs/Cassette
1005	0402	1.0 ± 0.05	0.5 ± 0.05	0.5 ± .05	0.2 to 0.4	0.3	50,000
1608	0603	1.6 ± 0.07	0.8 ± 0.07	0.8 ± .07	0.2 to 0.5	0.7	15,000
2012	0805	2.0 ± 0.10	1.25 ± 0.10	0.6 ± .10	0.5 to 0.75	0.75	10,000

Terminations: KEMET nickel barrier layer with a tin overplate.

CAPACITOR MARKING TABLE (Marking Optional - Not Available for 0402 Size or Y5V Dielectric)

Alpha Character	Capacitance (pF) For Various Numerical Identifiers								
	9	0	1	2	3	4	5	6	7
A	0.10	1.0	10	100	1000	10,000	100,000	1,000,000	10,000,000
B	0.11	1.1	11	110	1100	11,000	110,000	1,100,000	11,000,000
C	0.12	1.2	12	120	1200	12,000	120,000	1,200,000	12,000,000
D	0.13	1.3	13	130	1300	13,000	130,000	1,300,000	13,000,000
E	0.15	1.5	15	150	1500	15,000	150,000	1,500,000	15,000,000
F	0.16	1.6	16	160	1600	16,000	160,000	1,600,000	16,000,000
G	0.18	1.8	18	180	1800	18,000	180,000	1,800,000	18,000,000
H	0.20	2.0	20	200	2000	20,000	200,000	2,000,000	20,000,000
J	0.22	2.2	22	220	2200	22,000	220,000	2,200,000	22,000,000
K	0.24	2.4	24	240	2400	24,000	240,000	2,400,000	24,000,000
L	0.27	2.7	27	270	2700	27,000	270,000	2,700,000	27,000,000
M	0.30	3.0	30	300	3000	30,000	300,000	3,000,000	30,000,000
N	0.33	3.3	33	330	3300	33,000	330,000	3,300,000	33,000,000
P	0.36	3.6	36	360	3600	36,000	360,000	3,600,000	36,000,000
Q	0.39	3.9	39	390	3900	39,000	390,000	3,900,000	39,000,000
R	0.43	4.3	43	430	4300	43,000	430,000	4,300,000	43,000,000
S	0.47	4.7	47	470	4700	47,000	470,000	4,700,000	47,000,000
T	0.51	5.1	51	510	5100	51,000	510,000	5,100,000	51,000,000
U	0.56	5.6	56	560	5600	56,000	560,000	5,600,000	56,000,000
V	0.62	6.2	62	620	6200	62,000	620,000	6,200,000	62,000,000
W	0.68	6.8	68	680	6800	68,000	680,000	6,800,000	68,000,000
X	0.75	7.5	75	750	7500	75,000	750,000	7,500,000	75,000,000
Y	0.82	8.2	82	820	8200	82,000	820,000	8,200,000	82,000,000
Z	0.91	9.1	91	910	9100	91,000	910,000	9,100,000	91,000,000
a	0.25	2.5	25	250	2500	25,000	250,000	2,500,000	25,000,000
b	0.35	3.5	35	350	3500	35,000	350,000	3,500,000	35,000,000
d	0.40	4.0	40	400	4000	40,000	400,000	4,000,000	40,000,000
e	0.45	4.5	45	450	4500	45,000	450,000	4,500,000	45,000,000
f	0.50	5.0	50	500	5000	50,000	500,000	5,000,000	50,000,000
m	0.60	6.0	60	600	6000	60,000	600,000	6,000,000	60,000,000
n	0.70	7.0	70	700	7000	70,000	700,000	7,000,000	70,000,000
t	0.80	8.0	80	800	8000	80,000	800,000	8,000,000	80,000,000
y	0.90	9.0	90	900	9000	90,000	900,000	9,000,000	90,000,000

Laser marking is available as an extra-cost option for most KEMET ceramic chips. Such marking is two sided, and includes a \bar{K} to identify KEMET, followed by two characters (per EIA-198 - see table below) to identify the capacitance value. Note that marking is not available for size 0402 nor for any Y5V chip. In addition, the 0603 marking option is limited to the \bar{K} only.



Example shown is 1,000 pF capacitor.