

## Aluminum Capacitors Power Eurodin Screw Terminals

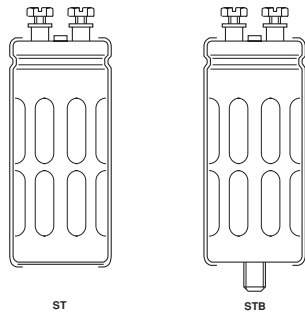

Fig. 1 Component outlines.



### FEATURES

- Polarized aluminum electrolytic capacitors, non-solid electrolyte
- Large types, cylindrical aluminum case, insulated with a blue sleeve
- Also available in bolt version (114/115 PED-STB)
- Pressure relief in the sealing
- Charge and discharge proof
- Extremely low ESR and ESL allowing very high ripple current load, achieved by a special construction with multiple internal anode and cathode connections
- Very long useful life: 20000 hours at 85 °C
- High resistance to shock and vibration achieved by longitudinal rills and special internal construction.

### APPLICATIONS

- Computer, telecommunications and industrial systems
- Smoothing and filtering
- Standard and switched mode power supplies
- Energy storage in pulse systems.

### MARKING

The capacitors are marked with the following information:

- Rated capacitance (in  $\mu\text{F}$ ).
- Tolerance on rated capacitance, code letter in accordance with IEC 60062 (Q for -10/+30%).
- Rated voltage (in V).
- Date code (YYMM).
- Name of manufacturer.
- Code for factory of origin.
- Code number.
- Climatic category in accordance with IEC 60068.
- "LL" for long life grade.

QUICK REFERENCE DATA		
DESCRIPTION	Value	
	114	115
Nominal case size ( $\varnothing D \times L$ in mm)	35 x 60 to 75 x 105	
Rated capacitance range (E6 series), $C_R$	150 to 220000 $\mu\text{F}$	
Tolerance on $C_R$	-10 to +30%	
Rated voltage range, $U_R$	10 to 100V	250 to 400V
Category temperature range	-40 to +85 °C	
Endurance test at 85 °C	8000 hours (400 V: 5000 hours)	
Useful life at 85 °C	20000 hours (400 V: 12000 hours)	
Useful life at 40 °C, $1.4 \times I_R$ applied	350000 hours (400 V: 220000 hours)	
Shelf life at 0 V, 85 °C	500 hours	
Based on sectional specification	IEC 60384-4/EN130300	
Climatic category IEC 60068	40/085/56	

$C_R$ ( $\mu\text{F}$ )	$U_R$ (V)					
	10	16	25	40	63	100
1000	-	-	-	-	-	35 x 60
1500	-	-	-	-	-	35 x 60
2200	-	-	-	-	35 x 60	35 x 80
3300	-	-	-	35 x 60	35 x 60	35 x 105
4700	-	-	35 x 60	35 x 60	35 x 80	50 x 80
6800	-	-	35 x 60	35 x 80	35 x 105	50 x 105
10000	-	35 x 60	35 x 80	35 x 105	50 x 80	65 x 105
15000	35 x 60	35 x 80	35 x 105	50 x 80	50 x 105	65 x 105
22000	35 x 80	35 x 105	50 x 80	50 x 105	65 x 105	75 x 105
33000	35 x 105	50 x 80	50 x 105	65 x 105	65 x 105	-
47000	50 x 80	50 x 105	65 x 105	65 x 105	75 x 105	-
68000	50 x 105	65 x 105	65 x 105	75 x 105	-	-
100000	65 x 105	65 x 105	75 x 105	-	-	-
150000	65 x 105	75 x 105	-	-	-	-
220000	75 x 105	-	-	-	-	-

<b>SELECTION CHART FOR <math>C_R</math>, <math>U_R</math> AND RELEVANT NOMINAL CASE SIZES (<math>\varnothing D \times L</math> in mm) for 115 PED-ST series</b>				
$C_R$ ( $\mu F$ )	$U_R$ (V)			
	250	350	385	400
150	–	–	35 × 60	35 × 60
220	–	35 × 60	35 × 80	35 × 80
330	35 × 60	35 × 80	35 × 105	35 × 105
470	35 × 80	35 × 105	50 × 80	50 × 80
680	35 × 105	50 × 80	50 × 105	50 × 105
1000	50 × 80	50 × 105	65 × 105	65 × 105
1500	50 × 105	65 × 105	65 × 105	65 × 105
2200	65 × 105	65 × 105	75 × 105	75 × 105
3300	65 × 105	75 × 105	–	–
4700	75 × 105	–	–	–

### DIMENSIONS in millimeters AND AVAILABLE FORMS

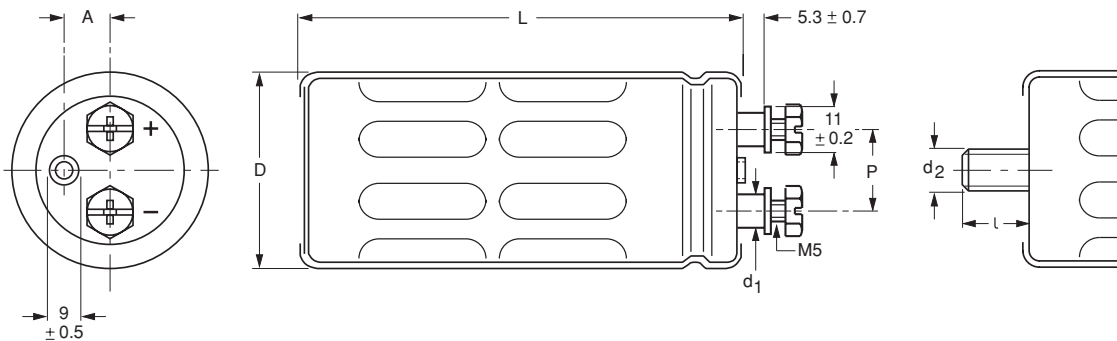

Maximum permissible torque which may be applied to the termination screws: 2 Nm.  
For accessories refer to data sheet "Mounting Accessories".  
The capacitors are delivered with screws and washers.

Fig.2 Screw terminal (ST); screw terminal bolt (STB).

Table 1

<b>DIMENSIONS in millimeters, MASS AND PACKAGING QUANTITIES</b>									
NOMINAL CASE SIZE $\varnothing D \times L$	$\varnothing D_{max}$	$L_{max}$	$P$ $\pm 0.1$	A	$d_1$ $\pm 0.2$	$d_2 \times l$	MASS (g)	PACKAGING QUANTITIES (per box)	CARDBOARD BOX DIMENSIONS $L \times W \times H$
35 × 60	36.5	63	13.0	8.4	8.0	M8 × 12	≈55	25	196 × 192 × 110
35 × 80	36.5	83	13.0	8.4	8.0	M8 × 12	≈80	25	196 × 192 × 115
35 × 105	36.5	108	13.0	8.4	8.0	M8 × 12	≈110	25	196 × 192 × 140
50 × 80	51.5	83	22.0	14.3	8.0	M12 × 16	≈160	25	293 × 273 × 115
50 × 105	51.5	108	22.0	14.3	8.0	M12 × 16	≈210	25	293 × 273 × 140
65 × 105	66.5	108	28.5	19.0	9.6	M12 × 16	≈370	10	368 × 151 × 140
75 × 105	76.5	108	32.0	21.0	9.6	M12 × 16	≈535	10	418 × 173 × 140



ELECTRICAL DATA	
SYMBOL	DESCRIPTION
C <sub>R</sub>	rated capacitance at 100 Hz, tolerance -10 to +30%
I <sub>R</sub>	rated RMS ripple current at 100 Hz, 85 °C
I <sub>L5</sub>	max. leakage current after 5 minutes at U <sub>R</sub>
ESR	typical equivalent series resistance at 100 Hz
Z	impedance at 20 kHz
Tan δ	max. dissipation factor at 100 Hz

**ORDERING EXAMPLE**

Electrolytic capacitor 114 PED-ST series  
10000 µF/25 V; -10/+30%  
Nominal case size: Ø35 × 80 mm; ST version  
Catalog number: 2222 114 16103.

**Note**

- Unless otherwise specified, all electrical values in Tables and apply at T<sub>amb</sub> = 20 °C, P = 86 to 106 kPa, RH = 45 to 75%.

Table 2

ELECTRICAL DATA AND ORDERING INFORMATION FOR THE 114 PED-ST SERIES									
U <sub>R</sub> (V)	C <sub>R</sub> 100 Hz (µF)	NOMINAL CASE SIZE ØD × L (mm)	I <sub>R</sub> 100 Hz 85 °C (A)	I <sub>L5</sub> 5 min (mA)	ESR TYP. 100 Hz (mΩ)	Tan δ MAX. 100 Hz	Z TYP. 20 kHz (mΩ)	Z MAX. 20 kHz (mΩ)	CATALOG NUMBER (see Table 3, note 1) 2222 114 .....
10	15000	35 × 60	6	0.30	20	0.32	13	20	14153
	22000	35 × 80	7.5	0.43	14	0.33	9.5	14	14223
	33000	35 × 105	10	0.66	10	0.35	7.5	10	14333
	47000	50 × 80	14	0.94	7.5	0.36	5.0	9.5	14473
	68000	50 × 105	18	1.36	5.5	0.38	4.0	8.0	14683
	100000	65 × 105	30	2.00	3.5	0.34	3.0	5.0	14104
	150000	65 × 105	30	3.00	3.0	0.45	3.0	5.0	14154
	220000	75 × 105	37	4.40	2.0	0.45	2.5	4.0	14224
16	10000	35 × 60	6	0.32	22	0.22	13	20	15103
	15000	35 × 80	7.5	0.40	15	0.23	9.5	14	15153
	22000	35 × 105	10	0.71	11	0.25	7.0	10	15223
	33000	50 × 80	13	1.06	7.5	0.26	5.0	9.5	15333
	47000	50 × 105	18	1.51	5.5	0.27	4.0	8.0	15473
	68000	65 × 105	28	2.18	3.5	0.24	3.0	5.0	15683
	100000	65 × 105	28	3.20	3.0	0.31	3.0	5.0	15104
	150000	75 × 105	37	4.80	2.0	0.31	2.5	4.0	15154
25	4700	35 × 60	5.2	0.24	30	0.14	15	23	16472
	6800	35 × 60	5.2	0.34	25	0.18	14	21	16682
	10000	35 × 80	6.7	0.50	18	0.18	10	15	16103
	15000	35 × 105	9.7	0.75	12	0.19	7.5	11	16153
	22000	50 × 80	12.5	1.10	8.5	0.19	5.5	9.5	16223
	33000	50 × 105	18	1.65	6.0	0.21	4.0	8.0	16333
	47000	65 × 105	27	2.35	4.0	0.18	3.0	5.0	16473
	68000	65 × 105	27	3.40	3.5	0.23	3.0	5.0	16683
100000	75 × 105	37	5.0	2.5	0.23	2.5	4.0	16104	
40	3300	35 × 60	4.5	0.27	37	0.13	21	32	17332
	4700	35 × 60	4.5	0.38	35	0.17	22	33	17472
	6800	35 × 80	6	0.55	25	0.17	15	23	17682
	10000	35 × 105	7.5	0.80	17	0.18	11	17	17103
	15000	50 × 80	10	1.20	11	0.17	7.5	13	17153
	22000	50 × 105	15	1.76	8.0	0.18	5.5	10.5	17223
	33000	65 × 105	21	2.64	5.0	0.16	3.5	6.0	17333
	47000	65 × 105	22	3.76	4.5	0.21	3.5	6.0	17473
68000	75 × 105	30	5.44	3.0	0.21	3.0	4.5	17683	
63	2200	35 × 60	3.7	0.28	39	0.09	22	33	18222
	3300	35 × 60	3.7	0.42	32	0.11	20	30	18332
	4700	35 × 80	5.2	0.66	23	0.11	14	21	18472
	6800	35 × 105	7.5	0.86	17	0.11	10	15	18682
	10000	50 × 80	9.5	1.26	12	0.12	7.5	14	18103
	15000	50 × 105	13.5	1.89	8.5	0.13	5.5	10.5	18153
	22000	65 × 105	21	2.77	5.0	0.11	3.5	6.0	18223
	33000	65 × 105	22	4.16	4.5	0.14	3.5	6.0	18333
47000	75 × 105	30	5.92	3.0	0.14	3.0	4.5	18473	
100	1000	35 × 60	3.0	0.20	85	0.09	45	67	19102
	1500	35 × 60	3.3	0.30	65	0.10	40	60	19152
	2200	35 × 80	4.6	0.41	45	0.10	28	42	19222
	3300	35 × 105	6.5	0.66	30	0.10	19	28	19332
	4700	50 × 80	7.4	0.94	27	0.11	17	25	19472
	6800	50 × 105	9.9	1.36	19	0.11	12	18	19682
	10000	65 × 105	15.0	2.00	11	0.11	7	11	19103
	15000	65 × 105	15.8	3.00	10	0.12	6	10	19153
22000	75 × 105	20.5	4.40	7	0.12	5	8	19223	

Table 3

ELECTRICAL DATA AND ORDERING INFORMATION FOR THE 115 PED-ST SERIES									
$U_R$ (V)	$C_R$ 100 Hz ( $\mu$ F)	NOMINAL CASE SIZE $\varnothing D \times L$ (mm)	$I_R$ 100 Hz 85 °C (A)	$I_{L5}$ 5 min (mA)	ESR TYP. 100 Hz (m $\Omega$ )	Tan $\delta$ MAX. 100 Hz	Z TYP. 20 kHz (m $\Omega$ )	Z MAX. 20 kHz (m $\Omega$ )	CATALOG NUMBER (see note 1) 2222 115 .....
250	330	35 × 60	1.8	0.17	300	0.15	275	500	13331
	470	35 × 80	2.5	0.24	250	0.15	140	375	13471
	680	35 × 105	3.5	0.34	180	0.15	125	300	13681
	1000	50 × 80	4.2	0.50	110	0.15	60	130	13102
	1500	50 × 105	6.3	0.75	60	0.15	40	100	13152
	2200	65 × 105	8.8	1.10	45	0.15	30	60	13222
	3300	65 × 105	10.5	1.65	30	0.15	25	50	13332
	4700	75 × 105	14	2.35	25	0.15	20	40	13472
350	220	35 × 60	1.9	0.16	360	0.10	220	480	15221
	330	35 × 80	2.5	0.23	245	0.10	150	320	15331
	470	35 × 105	3.2	0.33	175	0.10	105	230	15471
	680	50 × 80	3.9	0.48	140	0.10	60	130	15681
	1000	50 × 105	5.4	0.71	65	0.10	50	100	15102
	1500	65 × 105	7.7	1.05	55	0.10	30	70	15152
	2200	65 × 105	9.1	1.54	35	0.10	22	50	15222
	3300	75 × 105	10.8	2.31	30	0.12	20	45	15332
385	150	35 × 60	1.0	0.12	730	0.12	450	935	18151
	220	35 × 80	1.4	0.17	520	0.12	310	630	18221
	330	35 × 105	1.9	0.25	340	0.12	210	425	18331
	470	50 × 80	2.7	0.36	200	0.12	140	300	18471
	680	50 × 105	3.6	0.51	140	0.12	100	205	18681
	1000	65 × 105	5.1	0.75	95	0.12	65	125	18102
	1500	65 × 105	5.7	1.13	80	0.12	45	95	18152
	2200	75 × 105	7.3	1.65	55	0.12	40	75	18222
400	150	35 × 60	1.0	0.12	730	0.12	450	935	16151
	220	35 × 80	1.4	0.18	520	0.12	310	630	16221
	330	35 × 105	1.9	0.26	340	0.12	210	425	16331
	470	50 × 80	2.7	0.38	200	0.12	140	300	16471
	680	50 × 105	3.6	0.54	140	0.12	100	205	16681
	1000	65 × 105	5.1	0.80	95	0.12	65	125	16102
	1500	65 × 105	5.7	1.20	80	0.12	45	95	16152
	2200	75 × 105	7.3	1.76	55	0.12	40	75	16222

## Note

- Catalog number applies to the ST version; for STB version (not preferred) replace 8<sup>th</sup> digit by '5' (2222 114/115 5....).

ADDITIONAL ELECTRICAL DATA		
PARAMETER	CONDITIONS	VALUE
<b>Voltage</b>		
Surge voltage	≤ 250 V versions	$U_s = 1.15 \times U_R$
	≥ 350 V versions	$U_s = 1.1 \times U_R$
Reverse voltage		$U_{rev} \leq 1 \text{ V}$
<b>Current</b>		
Leakage current	after 1 minute at $U_R$	$I_{L1} \leq 0.006 C_R \times U_R + 4 \mu\text{F}$
	after 5 minutes at $U_R$	$I_{L5} \leq 0.002 C_R \times U_R + 4 \mu\text{F}$
<b>Inductance</b>		
Equivalent series inductance (ESL)	case $\varnothing D = 35 \text{ mm}$	typ. 13 nH
	case $\varnothing D = 50 \text{ mm}$	typ. 16 nH
	case $\varnothing D = 65 \text{ mm}$	typ. 19 nH
	case $\varnothing D = 75 \text{ mm}$	typ. 20 nH

**EQUIVALENT SERIES RESISTANCE (ESR)**

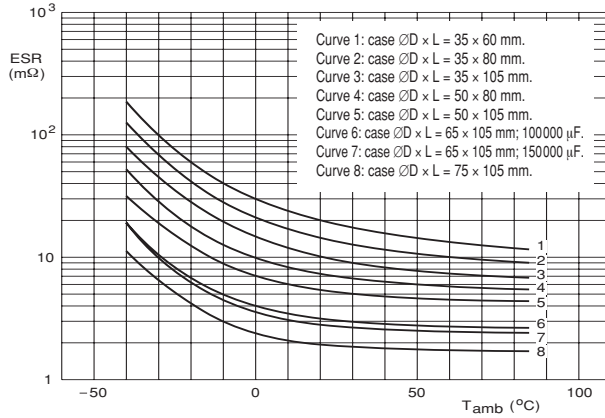

ESR at 100 Hz and  $U_R = 10$  V.

Fig.3 Typical ESR as a function of temperature.

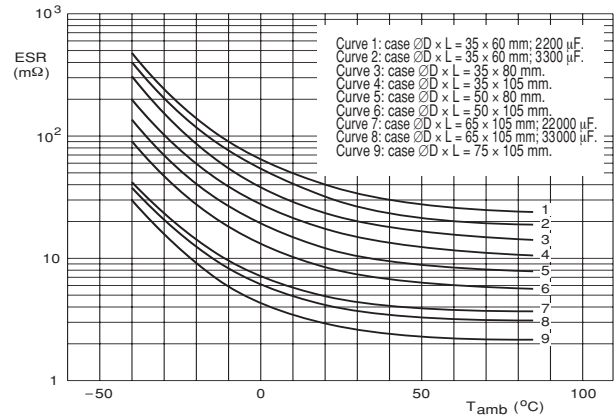

ESR at 100 Hz and  $U_R = 63$  V.

Fig.4 Typical ESR as a function of temperature.

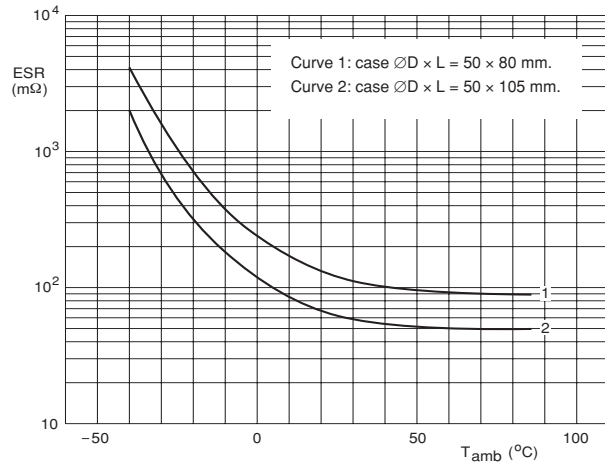

ESR at 100 Hz and  $U_R = 250$  V.

Fig.5 Typical ESR as a function of temperature.

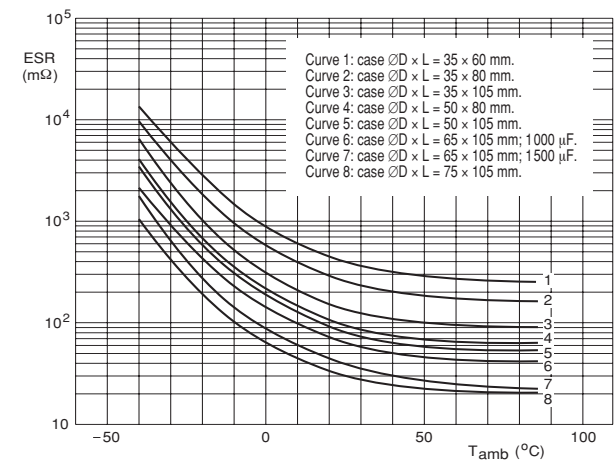

ESR at 100 Hz and  $U_R = 250$  V.

Fig.6 Typical ESR as a function of temperature.

**IMPEDANCE (Z)**

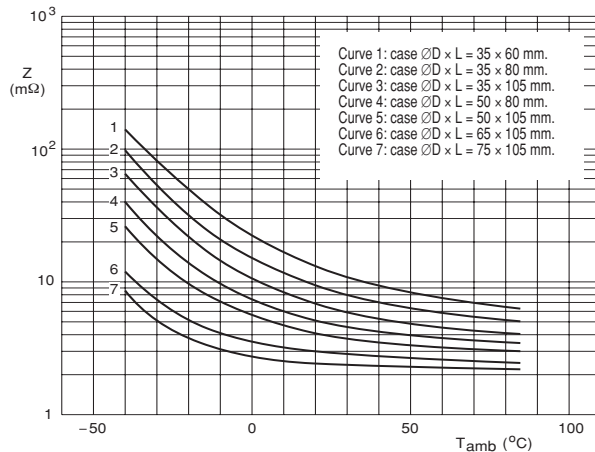

Z at 20 kHz and  $U_R = 10$  V.

Fig.7 Typical impedance as a function of temperature.

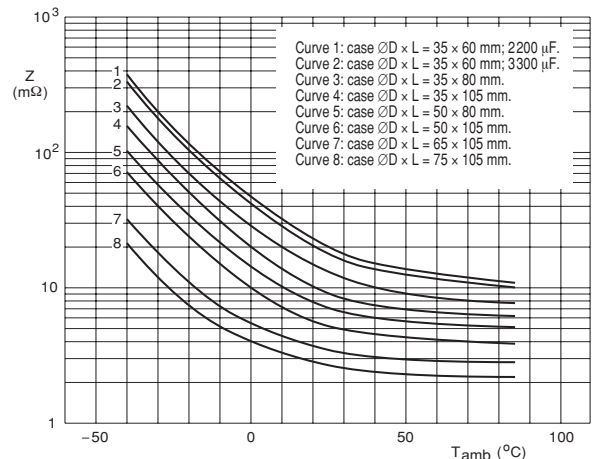

Z at 20 kHz and  $U_R = 63$  V.

Fig.8 Typical impedance as a function of temperature.



## IMPEDANCE (Z)

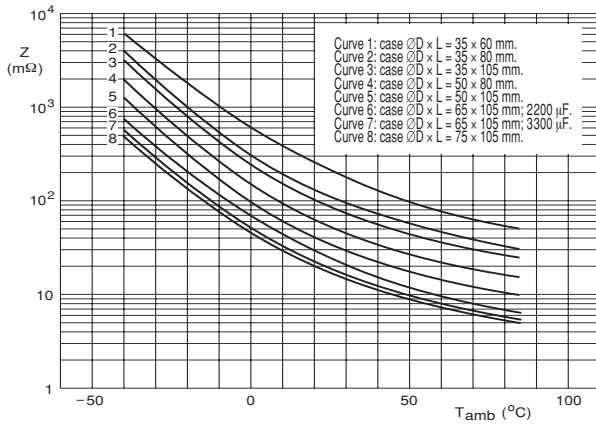

Z at 20 kHz and  $U_R = 250$  V.

Fig.9 Typical impedance as a function of temperature.

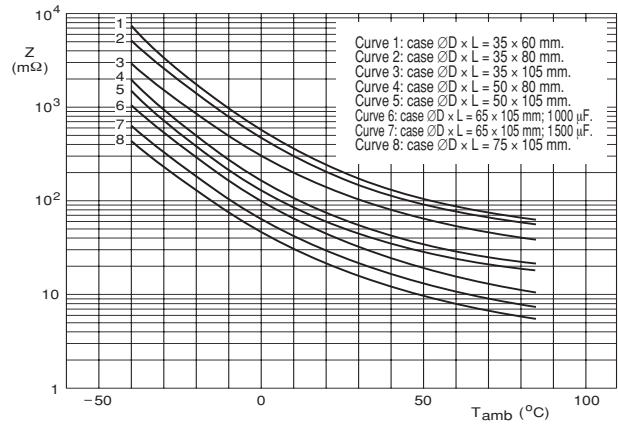

Z at 20 kHz and  $U_R = 385$  V.

Fig.10 Typical impedance as a function of temperature.

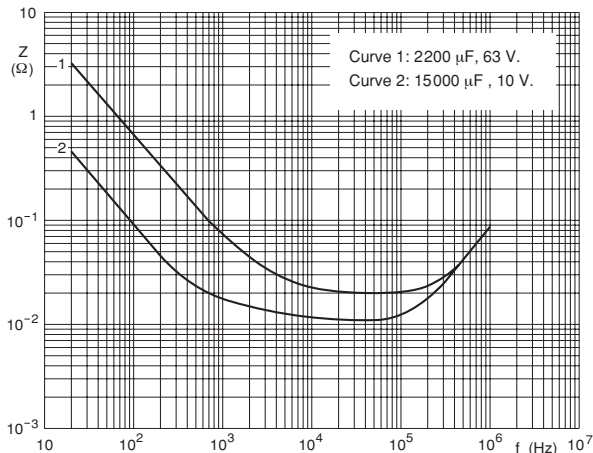

Case  $\varnothing D \times L = 35 \times 60$  mm.

$T_{\text{amb}} = 20$  °C.

Fig.11 Typical impedance as a function of frequency.

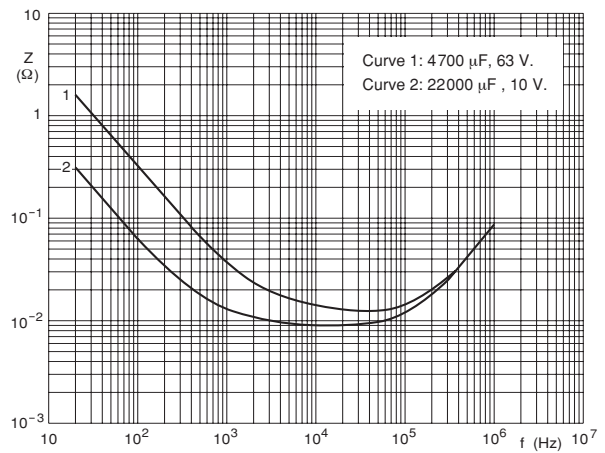

Case  $\varnothing D \times L = 35 \times 80$  mm.

$T_{\text{amb}} = 20$  °C.

Fig.12 Typical impedance as a function of frequency.

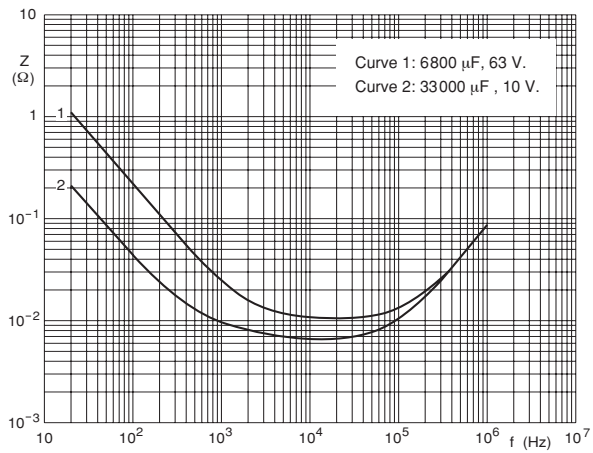

Case  $\varnothing D \times L = 35 \times 105$  mm.

$T_{\text{amb}} = 20$  °C.

Fig.13 Typical impedance as a function of frequency.

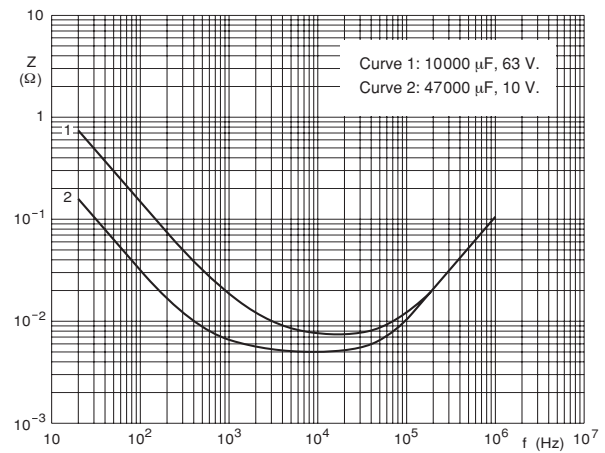

Case  $\varnothing D \times L = 50 \times 80$  mm.

$T_{\text{amb}} = 20$  °C.

Fig.14 Typical impedance as a function of frequency.

**IMPEDANCE (Z)**

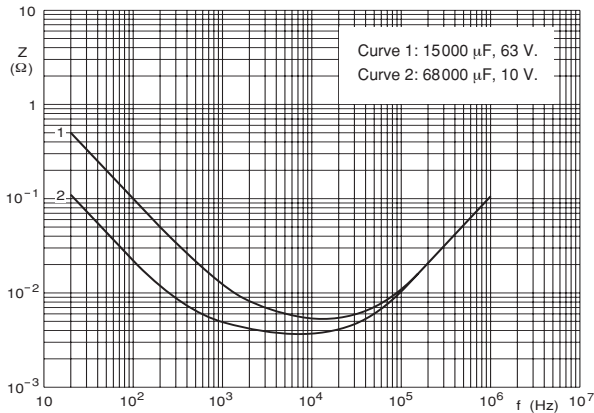

Case  $\varnothing D \times L = 50 \times 105$  mm.  $T_{amb} = 20$  °C.  
Fig.15 Typical impedance as a function of frequency.

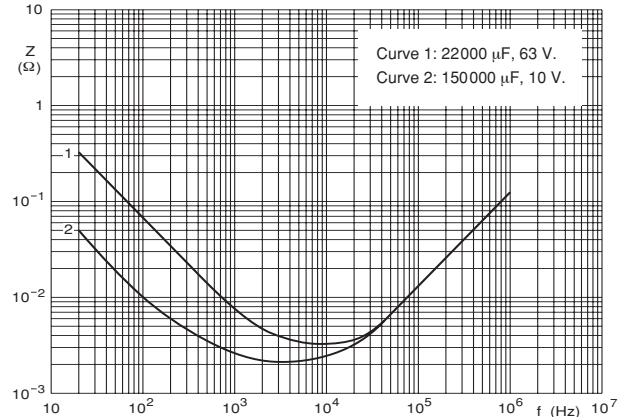

Case  $\varnothing D \times L = 65 \times 105$  mm.  $T_{amb} = 20$  °C.  
Fig.16 Typical impedance as a function of frequency.

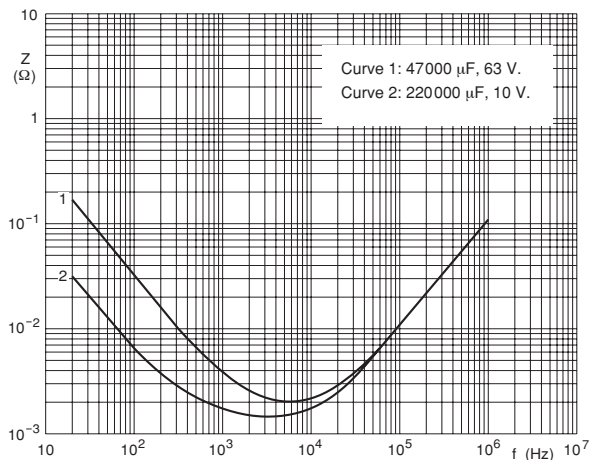

Case  $\varnothing D \times L = 75 \times 105$  mm.  $T_{amb} = 20$  °C.  
Fig.17 Typical impedance as a function of frequency.

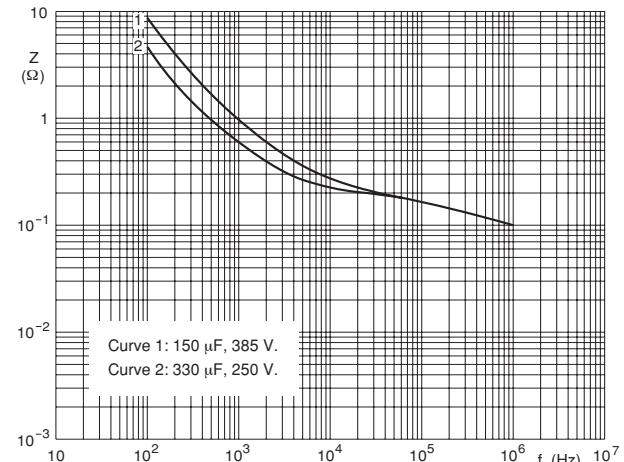

Case  $\varnothing D \times L = 35 \times 60$  mm.  $T_{amb} = 20$  °C.  
Fig.18 Typical impedance as a function of frequency.

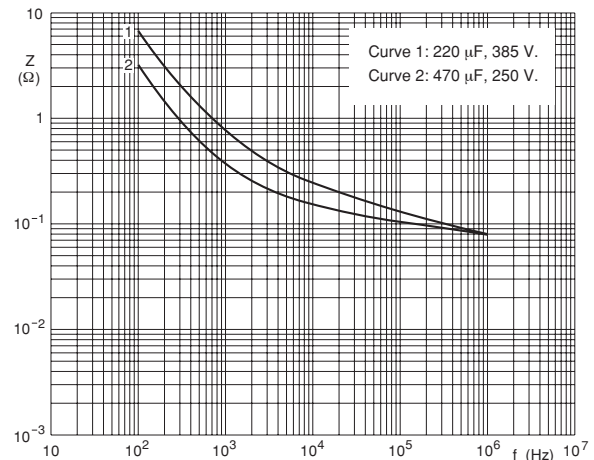

Case  $\varnothing D \times L = 35 \times 80$  mm.  $T_{amb} = 20$  °C.  
Fig.19 Typical impedance as a function of frequency.

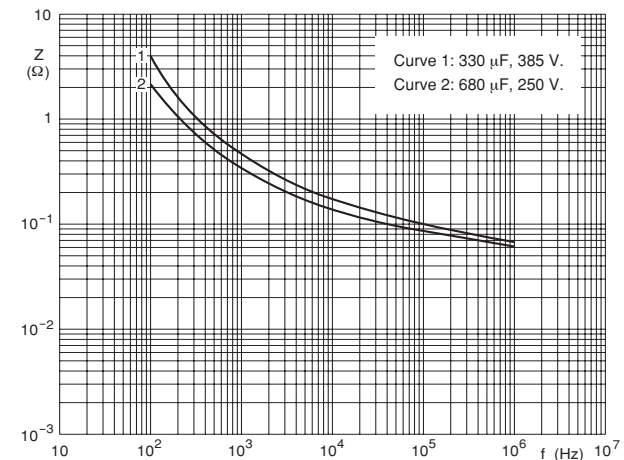

Case  $\varnothing D \times L = 35 \times 105$  mm.  $T_{amb} = 20$  °C.  
Fig.20 Typical impedance as a function of frequency.





## IMPEDANCE (Z)

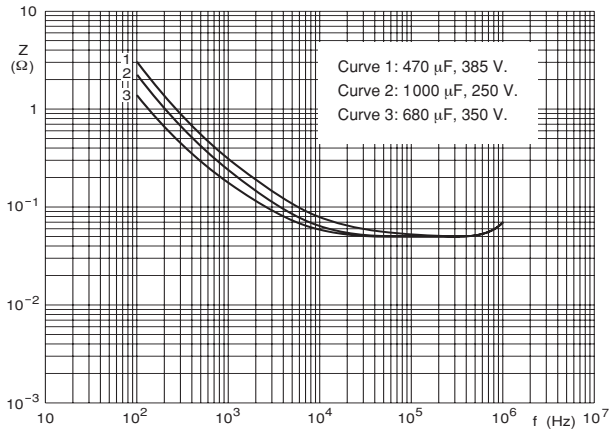

Case  $\varnothing D \times L = 50 \times 80$  mm.  $T_{amb} = 20$  °C.

Fig.21 Typical impedance as a function of frequency.

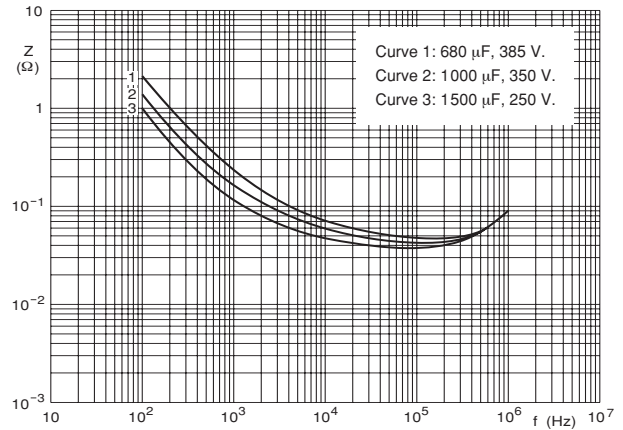

Case  $\varnothing D \times L = 50 \times 105$  mm.  $T_{amb} = 20$  °C.

Fig.22 Typical impedance as a function of frequency.

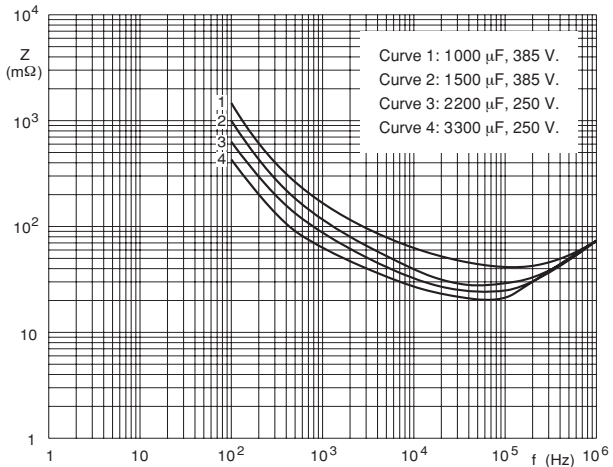

Case  $\varnothing D \times L = 65 \times 105$  mm.  $T_{amb} = 20$  °C.

Fig.23 Typical impedance as a function of frequency.

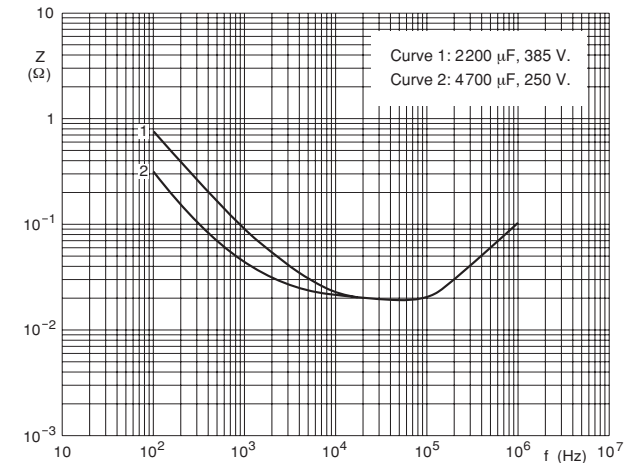

Case  $\varnothing D \times L = 75 \times 105$  mm.  $T_{amb} = 20$  °C.

Fig.24 Typical impedance as a function of frequency.



**RIPPLE CURRENT AND USEFUL LIFE**

Fig.25 Multiplier of useful life as a function of ambient temperature and ripple current load.

**Table 4**

MULTIPLIER OF RIPPLE CURRENT ( $i_R$ ) AS A FUNCTION OF FREQUENCY	
FREQUENCY (Hz)	$i_R$ MULTIPLIER
50	0.83
100	1.00
200	1.10
400	1.15
1000	1.19
≥2000	1.20

Table 5

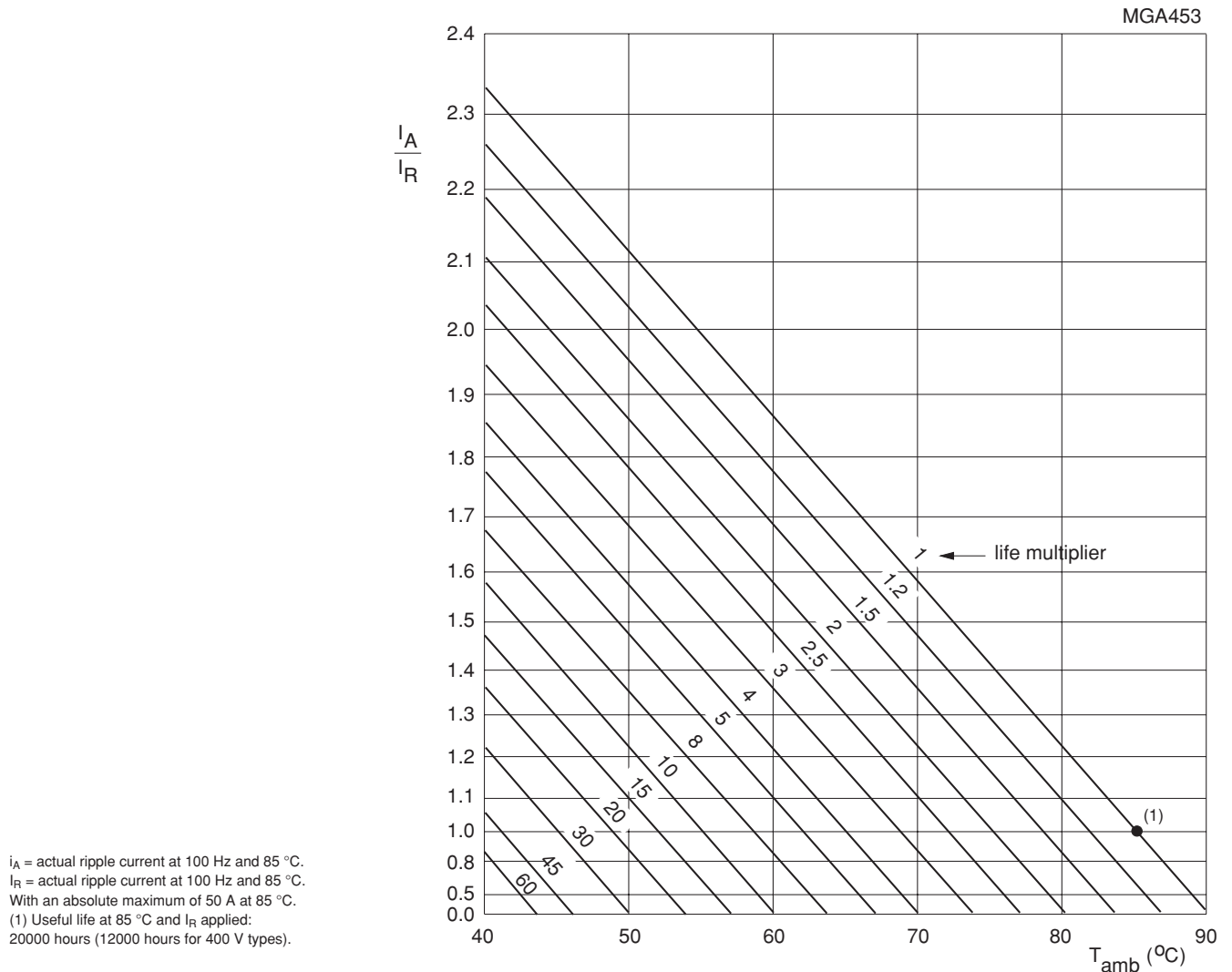
<b>TEST PROCEDURES AND REQUIREMENTS</b>			
<b>TEST</b>		<b>PROCEDURE (quick reference)</b>	<b>REQUIREMENTS</b>
<b>NAME OF TEST</b>	<b>REFERENCE</b>		
Endurance	IEC 60384-4/ EN130300 subclause 4.13	$T_{amb} = 85\text{ }^{\circ}\text{C}$ ; $U_R$ applied; 8000 hours (400 V types: 5000 hours)	$U_R \leq 100\text{ V}$ ; $\Delta C/C: \pm 15\%$ $U_R > 100\text{ V}$ ; $\Delta C/C: \pm 10\%$ $\tan \delta \leq 1.3 \times \text{spec. limit}$ $Z \leq 2 \times \text{spec. limit}$ $I_{L5} \leq \text{spec. limit}$
Useful life	CECC 30301 subclause 1.8.1	$T_{amb} = 85\text{ }^{\circ}\text{C}$ ; $U_R$ and $I_R$ applied; 20000 hours (400 V types: 12000 hours)	$U_R \leq 100\text{ V}$ ; $\Delta C/C: \pm 45\%$ $U_R > 100\text{ V}$ ; $\Delta C/C: \pm 30\%$ $\tan \delta \leq 3 \times \text{spec. limit}$ $Z \leq 3 \times \text{spec. limit}$ $I_{L5} \leq \text{spec. limit}$ no short or open circuit, no visible damage total failure percentage: $U_R \leq 100\text{ V}: \leq 1\%$ ; $U_R > 100\text{ V}: \leq 3\%$
Shelf life (storage at high temperature)	IEC 60384-4/ EN130300 subclause 4.17	$T_{amb} = 85\text{ }^{\circ}\text{C}$ ; no voltage applied; 500 hours after test: $U_R$ to be applied for 30 minutes, 24 to 48 hours before measurement	$\Delta C/C: \pm 10\%$ $\tan \delta \leq 1.2 \times \text{spec. limit}$ $I_{L5} \leq 2 \times \text{spec. limit}$