

**For professional current converter technology  
Voltage ratings up to 500 Vdc**

**Construction**

- Charge-discharge proof, polar
- Aluminum case with insulating sleeve
- Poles with screw terminal connections
- Mounting with ring clips or threaded stud
- The bases of types with threaded stud and  $d \leq 76,9$  mm are not insulated, types with  $d = 91$  mm have fully insulated bases

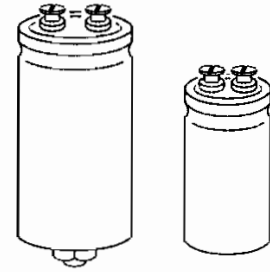

KAL0272-T

B 41 584    B 41 564  
B 43 584    B 43 564

**Features**

- High reliability
- Extremely good electrical characteristics and small dimensions
- High ripple current capability
- All-welded construction ensures reliable electrical contact

**Applications**

- General industrial electronics
- For switch-mode power supplies in professional equipment
- For intermediate circuits in converters

**Specifications and characteristics in brief**

	B 41 564, B 41 584	B 43 564, B 43 584
Rated voltage $V_R$	16 ... 100 Vdc	160 ... 500 Vdc
Surge voltage $V_S$	$1,15 \cdot V_R$	$1,15 \cdot V_R$ (for $V_R \leq 250$ Vdc) $1,1 \cdot V_R$ (for $V_R \geq 350$ Vdc)
Rated capacitance $C_R$	1000 ... 220 000 $\mu$ F	100 ... 22 000 $\mu$ F
Capacitance tolerance	- 10/+ 30 % $\triangleq$ Q	$\pm 20$ % $\triangleq$ M
Service life <sup>1)</sup>		
40 °C, $V_R$	> 200 000 h ( $1,8 \cdot I_{acR,85^\circ C}$ )	> 200 000 h ( $1,6 \cdot I_{acR,85^\circ C}$ )
85 °C, $V_R, I_{acR}$	> 8 000 h	> 15 000 h
Fraction failure	$\leq 0,5$ % (during the service life)	$\leq 1$ % (during the service life)
Failure rate	$\leq 20$ fit ( $\leq 20 \cdot 10^{-9}/h$ )	$\leq 40$ fit ( $\leq 40 \cdot 10^{-9}/h$ )
Voltage endurance test	2000 h, 85 °C (at $V_R, I_{acR}$ )	2000 h, 85 °C (at $V_R, I_{acR}$ )

1) Preliminary values for capacitors with  $V_R = 500$  Vdc

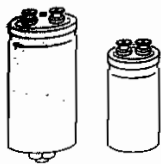

**B 41 564, B 41 584**  
**B 43 564, B 43 584**

Leakage current $I_{lka}$ (5 min, 20 °C)	$1000 \mu\text{C} \leq C_R \cdot V_R < 470\,000 \mu\text{C}$ : $I_{lka} \leq 0,006 \mu\text{A} \cdot \left( \frac{C_R}{\mu\text{F}} \cdot \frac{V_R}{\text{V}} \right) + 4 \mu\text{A}$  $C_R \cdot V_R \geq 470\,000 \mu\text{C}$ : $I_{lka} \leq 0,3 \mu\text{A} \cdot \left( \frac{C_R}{\mu\text{F}} \cdot \frac{V_R}{\text{V}} \right)^{0,7} + 4 \mu\text{A}$
Self-inductance $ESL$	approx. 20 nH
IEC climatic category	in accordance with IEC 68-1 $\leq 100 \text{ Vdc}$ : 40/085/56 (-40 °C/+85 °C) $\geq 160 \text{ Vdc}$ : 25/085/56 (-25 °C/+85 °C)
Detail specifications	similar to CECC 30 301-803, CECC 301-807, CECC 30 301-046 similar to DIN 45 910 part 128
Sectional specifications	IEC 384-4 DIN 45 910 part 12
Vibration resistance	in accordance with IEC 68-2-6, test Fc: displacement amplitude 0,75 mm, frequency range 10 ... 55 Hz, acceleration max. 10 g, duration 3 x 2 h

Due to the current load capability of the contact elements, the following current limits must not be exceeded, even if the frequency and temperature factors have been taken into account:

Capacitor diameter	$\leq 51,6 \text{ mm}$	64,3 mm	76,9 mm	91,0 mm
Maximum current	30 A	40 A	50 A	60 A

### Accessories

The following items are included in the delivery package, but are not fastened to the capacitors:

	Thread	Toothed washers	Screws/nuts	Maximum torque
For terminals	M 5	A 5,1 DIN 6797	Cylinder-head screw M 5 x 8 DIN 84-4.8	2 Nm
	M 6	A 6,4 DIN 6797	Cylinder-head screw M 6 x 12 DIN 85-4.8	2,5 Nm
For mounting	M 8	J 8,2 DIN 6797	Hex nut BM 8 DIN 439	4 Nm
	M 12	J 12,5 DIN 6797	Hex nut BM 12 DIN 439	10 Nm

The following must be ordered separately:

Ring clips            B 44 030 (cf. page 125)

Insulating parts    B 44 020 (cf. page 122)

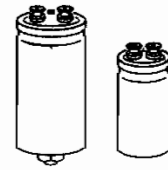

**Types B 41 564, B 43 564**  
 Ring clip mounting

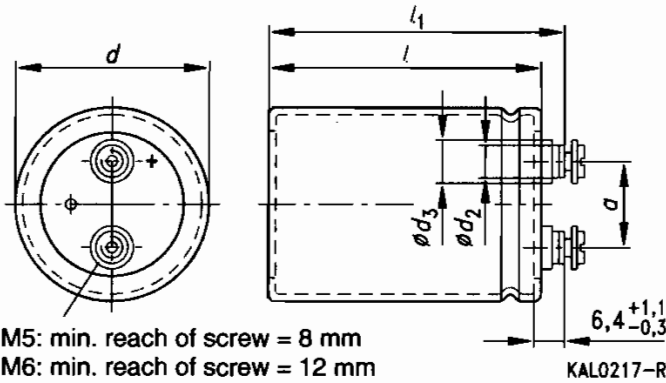

M5: min. reach of screw = 8 mm  
 M6: min. reach of screw = 12 mm

**Types B 41 584, B 43 584**  
 Threaded stud mounting

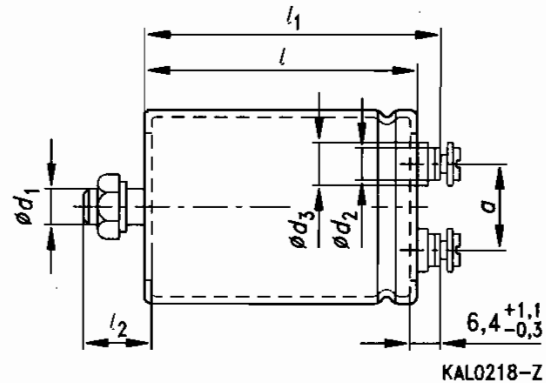

Positive pole marking: +

The base of all types with stud mounting and  $d = 91$  mm is fully insulated (the length  $l$  is increased by 1 mm in these cases). Also refer to the notes on mounting given on page 124.

Ter- minal	Dimensions (mm) with insulating sleeve								Approx. wt. (g)
	$d$	$l_{-3,2}^{+0}$	$l_1$ max	$l_2^{+0}_{-1}$	$d_1$	$d_2$ max	$d_3$ max	$a^{+0,2}_{-0,8}$	
M 5	35,7+0/-0,8	56,7	64,2	13	M 8	8,2	13,5	12,7	65
M 5	35,7+0/-0,8	82,1	89,6	13	M 8	8,2	13,5	12,7	105
M 5	35,7+0/-0,8	107,5	115,0	13	M 8	8,2	13,5	12,7	135
M 5	51,6+0/-0,8	82,1	89,6	17	M 12	8,2	13,5	22,2	220
M 5	51,6+0/-0,8	107,5	115,0	17	M 12	8,2	13,5	22,2	280
M 5	64,3+0/-0,8	107,5	115,0	17	M 12	8,2	13,5	28,5	440
M 6	76,9+0/-0,7	107,5	115,0	17	M 12	17,7	17,7	31,7	540
M 6	76,9+0/-0,7	145,6	153,1	17	M 12	17,7	17,7	31,7	840
M 6	76,9+0/-0,7	221,8	229,3	17	M 12	17,7	17,7	31,7	1300
M 6	91,0+0/-2	107,5	115,0	17	M 12	17,7	17,7	31,7 <sup>1)</sup>	750
M 6	91,0+0/-2	146,0	153,5	17	M 12	17,7	17,7	31,7 <sup>1)</sup>	1200
M 6	91,0+0/-2	222,0	229,5	17	M 12	17,7	17,7	31,7 <sup>1)</sup>	1900

**Packing units**

Capacitor diameter $d$	Packing units (pieces)
35,7 mm	72
51,6 mm	36
64,3 mm	20
76,9 mm	16
91,0 mm	8

1) Tolerance  $\pm 0,8$

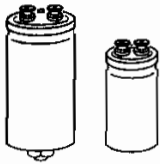

**B 41 564, B 41 584**  
**B 43 564, B 43 584**

### Overview of available types

#### Types B 41 564, B 41 584

$V_R$ (Vdc)	16	25	40	63	100
$C_R$ ( $\mu$ F)	Case dimensions $d \times l$ (mm)				
1 000					35,7 × 56,7
2 200				35,7 × 56,7	35,7 × 82,1
3 300					51,6 × 82,1
4 700		35,7 × 56,7	35,7 × 82,1	35,7 × 107,5	51,6 × 107,5
6 800				51,6 × 82,1	64,3 × 107,5
10 000	35,7 × 56,7	35,7 × 82,1	35,7 × 107,5	51,6 × 82,1	64,3 × 107,5
15 000	35,7 × 82,1	35,7 × 107,5	51,6 × 82,1	51,6 × 107,5	76,9 × 145,6
22 000	35,7 × 82,1	51,6 × 82,1	51,6 × 107,5	64,3 × 107,5	76,9 × 145,6
33 000	35,7 × 107,5	51,6 × 82,1	64,3 × 107,5	76,9 × 107,5	76,9 × 221,8 <sup>1)</sup>
47 000	51,6 × 82,1	64,3 × 107,5	76,9 × 107,5	76,9 × 145,6	
68 000	51,6 × 107,5	64,3 × 107,5	76,9 × 145,6	76,9 × 221,8 <sup>1)</sup>	
100 000	64,3 × 107,5	76,9 × 107,5	76,9 × 221,8 <sup>1)</sup>		
150 000	76,9 × 107,5	76,9 × 145,6			
220 000	76,9 × 145,6				

1) Only with ring clip mounting

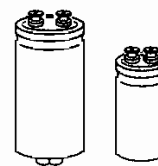

**Overview of available types**

**Types B 43 564, B 43 584**

$V_R$ (Vdc)	160	250	350	400	450	500
$C_R$ ( $\mu$ F)	Case dimensions $d \times l$ (mm)					
100						35,7 × 56,7
150						35,7 × 82,1
220			35,7 × 56,7	35,7 × 56,7	35,7 × 82,1	35,7 × 82,1
330						35,7 × 107,5
470	35,7 × 56,7	35,7 × 56,7	35,7 × 82,1	35,7 × 82,1	35,7 × 107,5	51,6 × 82,1
680						51,6 × 107,5
1 000	35,7 × 82,1	35,7 × 82,1	51,6 × 82,1	51,6 × 82,1	51,6 × 107,5	64,3 × 107,5
1 500	35,7 × 107,5	51,6 × 82,1	51,6 × 107,5	51,6 × 107,5	64,3 × 107,5	76,9 × 107,5
2 200	51,6 × 82,1	51,6 × 82,1	64,3 × 107,5	64,3 × 107,5	76,9 × 107,5	76,9 × 145,6
3 300	51,6 × 107,5	51,6 × 107,5	76,9 × 107,5	76,9 × 145,6	76,9 × 145,6	76,9 × 221,8
4 700	64,3 × 107,5	64,3 × 107,5	76,9 × 145,6	91,0 × 107,5	76,9 × 221,8 91,0 × 146,0	91,0 × 222,0
5 600						91,0 × 222,0
6 000			76,9 × 145,6	76,9 × 221,8	76,9 × 221,8	
6 800	64,3 × 107,5	76,9 × 145,6		91,0 × 146,0		
8 200			91,0 × 146,0			
10 000	76,9 × 107,5	76,9 × 145,6	76,9 × 221,8			
15 000	76,9 × 145,6	91,0 × 146,0				
22 000	76,9 × 221,8 91,0 × 146,0					

The capacitance and voltage ratings listed above are available in smaller cases upon request. Other voltage and capacitance ratings are also available upon request.

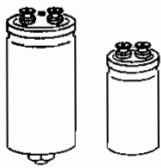

**B 41 564, B 41 584**  
**B 43 564, B 43 584**

**Technical data and ordering codes**

$V_R$	$C_R$	Case dimensions $d \times l$	$ESR_{typ}$ 100 Hz 20 °C	$ESR_{max}$ 100 Hz 20 °C	$Z_{max}$ 10 kHz 20 °C	$I_{ac_{max}}$ 100 Hz 40 °C	$I_{acR}$ 100 Hz 85 °C	$I_{ac_{max}}$ 100 Hz 85 °C	Ordering code
Vdc	$\mu F$	mm	m $\Omega$	m $\Omega$	m $\Omega$	A	A	A	Short code
<b>B41564-, B41584-</b>									
16	10 000	35,7 × 56,7	27	42	40	9,9	3,4	5,4	-A4109-Q
	15 000	35,7 × 82,1	20	32	32	13	4,4	7,0	-A4159-Q
	22 000	35,7 × 82,1	17	26	26	14	4,8	7,7	-B4229-Q
	33 000	35,7 × 107,5	14	21	23	17	5,8	9,3	-J 4339-Q
	47 000	51,6 × 82,1	12	18	20	18	6,3	10	-B4479-Q
	68 000	51,6 × 107,5	11	16	19	21	7,2	12	-J 4689-Q
	100 000	64,3 × 107,5	10	15	18	24	8,4	13	-J 4100-Q
	150 000	76,9 × 107,5	9	14	17	26	9,0	14	-B4150-Q
	220 000	76,9 × 145,6	9	13	15	29	10	16	-B4220-Q
25	4 700	35,7 × 56,7	35	65	60	9	3,0	5	-A5478-Q
	10 000	35,7 × 82,1	21	37	36	13	4,3	7,2	-A5109-Q
	15 000	35,7 × 107,5	16	29	29	16	5,4	8,6	-A5159-Q
	22 000	51,6 × 82,1	13	23	25	18	6,1	9,8	-A5229-Q
	33 000	51,6 × 82,1	11	20	21	19	6,6	11	-B5339-Q
	47 000	64,3 × 107,5	10	17	19	24	8,4	13	-A5479-Q
	68 000	64,3 × 107,5	10	16	18	24	8,4	13	-J 5689-Q
	100 000	76,9 × 107,5	9	15	17	26	9,0	14	-B5100-Q
	150 000	76,9 × 145,6	9	14	15	29	10	16	-B5150-Q
40	4 700	35,7 × 82,1	30	57	51	11	3,5	6,1	-A7478-Q
	10 000	35,7 × 107,5	18	33	32	16	5,1	9,0	-A7109-Q
	15 000	51,6 × 82,1	14	26	26	17	5,8	9,3	-A7159-Q
	22 000	51,6 × 107,5	10	22	23	22	7,6	12	-A7229-Q
	33 000	64,3 × 107,5	9	18	20	26	8,9	14	-A7339-Q
	47 000	76,9 × 107,5	8	17	19	28	9,5	15	-B7479-Q
	68 000	76,9 × 145,6	7	15	18	35	12	19	-B7689-Q
	100 000	76,9 × 221,8	7	13	18	41	14	22	-B7100-Q
	63	2 200	35,7 × 56,7	44	92	83	7,8	2,7	4,3
4 700		35,7 × 107,5	24	49	47	13	4,4	7,0	-A8478-Q
6 800		51,6 × 82,1	18	38	37	15	5,1	8,2	-A8688-Q
10 000		51,6 × 82,1	14	30	30	17	5,8	9,3	-B8109-Q
15 000		51,6 × 107,5	12	24	25	20	6,9	11	-J 8159-Q
22 000		64,3 × 107,5	10	20	22	24	8,4	13	-J 8229-Q
33 000		76,9 × 107,5	9	17	20	26	9,0	14	-B8339-Q
47 000		76,9 × 145,6	8	16	18	32	11	18	-B8479-Q
68 000		76,9 × 221,8	7	15	18	41	14	22	-B8689-Q

For instructions on how to determine ordering codes, refer to page 76.



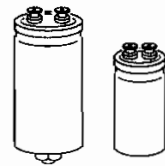

**Technical data and ordering codes**

$V_R$	$C_R$	Dimensions $d \times l$	$ESR_{typ}$ 100 Hz 20 °C	$ESR_{max}$ 100 Hz 20 °C	$Z_{max}$ 10 kHz 20 °C	$I_{ac,max}$ 100 Hz 40 °C	$I_{ac,R}$ 100 Hz 85 °C	$I_{ac,max}$ 100 Hz 85 °C	Ordering code	
Vdc	$\mu F$	mm	m $\Omega$	m $\Omega$	m $\Omega$	A	A	A	Short code	
<b>B41564-, B41584-</b>										
100	1 000	35,7 × 56,7	51	130	115	7,3	2,5	4,0	-A9108-Q	
	2 200	35,7 × 82,1	27	68	61	11	3,8	6,1	-A9228-Q	
	3 300	51,6 × 82,1	20	50	45	14	4,9	7,8	-A9338-Q	
	4 700	51,6 × 107,5	16	40	39	17	6,0	9,6	-A9478-Q	
	6 800	64,3 × 107,5	13	33	33	21	7,4	12	-A9688-Q	
	10 000	64,3 × 107,5	11	27	27	23	8,0	13	-A9109-Q	
	15 000	76,9 × 145,6	10	22	23	28	9,6	15	-B9159-Q	
	22 000	76,9 × 145,6	9	18	20	29	10	16	-B9229-Q	
	33 000	76,9 × 221,8	8	16	18	38	13	21	-B9339-Q	
<b>B43564-, B43584-</b>										
160	470	35,7 × 56,7	260	410	370	4,8	2,2	2,6	-A1477-M	
	1 000	35,7 × 82,1	130	200	180	7,5	3,4	4,1	-A1108-M	
	1 500	35,7 × 107,5	85	130	120	10	4,7	5,6	-A1158-M	
	2 200	51,6 × 82,1	57	86	79	13	5,8	6,9	-A1228-M	
	3 300	51,6 × 107,5	40	60	56	17	7,6	9,1	-A1338-M	
	4 700	64,3 × 107,5	31	47	44	21	10	12	-A1478-M	
	6 800	64,3 × 107,5	23	35	35	25	11	13	-A1688-M	
	10 000	76,9 × 107,5	17	26	26	29	13	16	-A1109-M	
	15 000	76,9 × 145,6	12	18	18	35	16	19	-A1159-M	
	22 000	76,9 × 221,8	9	14	14	48	22	26	-A1229-M	
	22 000	91,0 × 146,0	8	14	14	48	22	26	-J 1229-M	
	250	470	35,7 × 56,7	170	260	230	5,9	2,7	3,2	-A2477-M
		1 000	35,7 × 82,1	93	140	130	8,9	4,1	4,9	-A2108-M
1 500		51,6 × 82,1	71	110	100	11	5,2	6,2	-A2158-M	
2 200		51,6 × 82,1	51	77	74	13	6,1	7,3	-A2228-M	
3 300		51,6 × 107,5	36	54	52	18	8,0	9,6	-A2338-M	
4 700		64,3 × 107,5	27	41	41	23	10	12	-A2478-M	
6 800		76,9 × 145,6	20	30	30	30	14	16	-A2688-M	
10 000		76,9 × 145,6	15	23	23	34	16	19	-A2109-M	
15 000		91,0 × 146,0	10	18	18	46	21	25	-A2159-M	
350	220	35,7 × 56,7	310	470	400	4,4	2,0	2,4	-A4227-M	
	470	35,7 × 82,1	150	230	200	7,0	3,2	3,8	-A4477-M	
	1 000	51,6 × 82,1	86	130	120	10	4,7	5,6	-A4108-M	
	1 500	51,6 × 107,5	62	93	93	13	6,1	7,3	-A4158-M	
	2 200	64,3 × 107,5	48	72	66	17	8,0	9,3	-A4228-M	
	3 300	76,9 × 107,5	32	48	47	21	10	11	-A4338-M	
	4 700	76,9 × 145,6	25	38	38	27	12	15	-A4478-M	
	6 000	76,9 × 145,6	21	32	32	29	13	16	-A4608-M	
	8 200	91,0 × 146,0	13	23	23	41	18	22	-A4828-M	
	10 000	76,9 × 221,8	13	20	20	44	20	24	-A4109-M	

For instructions on how to determine ordering codes, refer to page 76.

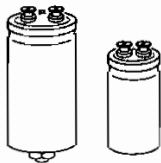

**B 41 564, B 41 584**  
**B 43 564, B 43 584**

**Technical data and ordering codes**

$V_R$	$C_R$	Dimensions $d \times l$	$ESR_{typ}$ 100 Hz 20 °C	$ESR_{max}$ 100 Hz 20 °C	$Z_{max}$ 10 kHz 20 °C	$I_{ac,max}$ 100 Hz 40 °C	$I_{acR}$ 100 Hz 85 °C	$I_{ac,max}$ 100 Hz 85 °C	Ordering code
Vdc	$\mu F$	mm	m $\Omega$	m $\Omega$	m $\Omega$	A	A	A	Short code
<b>B43564-, B43584-</b>									
400	220	35,7 × 56,7	310	470	400	4,4	2,0	2,4	-A227-M
	470	35,7 × 82,1	150	230	210	7,0	3,2	3,8	-A477-M
	1 000	51,6 × 82,1	86	130	120	10	4,7	5,6	-A108-M
	1 500	51,6 × 107,5	62	93	84	13	6,1	7,3	-A158-M
	2 200	64,3 × 107,5	48	72	65	17	7,7	9,3	-A228-M
	3 300	76,9 × 145,6	36	54	51	22	10	12	-A338-M
	4 700	91,0 × 107,5	23	41	41	27	12	15	-A478-M
	6 000	76,9 × 221,8	21	32	32	35	16	19	-A608-M
6 800	91,0 × 146,0	15	27	27	38	17	21	-A688-M	
450	220	35,7 × 82,1	360	540	460	4,5	2,1	2,5	-A5227-M
	470	35,7 × 107,5	170	260	240	7,3	3,3	4,0	-A5477-M
	1 000	51,6 × 107,5	93	140	130	11	5,0	6,0	-A5108-M
	1 500	64,3 × 107,5	66	99	89	14	6,6	7,9	-A5158-M
	2 200	76,9 × 107,5	48	72	65	17	7,8	9,3	-A5228-M
	3 300	76,9 × 145,6	34	51	49	23	10	12	-A5338-M
	4 700	76,9 × 221,8	25	38	38	32	14	17	-A5478-M
	4 700	91,0 × 146,0	25	38	38	32	15	17	-J 5478-M
6 000	76,9 × 221,8	21	32	32	35	16	19	-A5608-M	
500	100	35,7 × 56,7	800	1200	1100	1,9	0,9	1,1	-A6107-M
	150	35,7 × 82,1	540	810	730	2,6	1,2	1,4	-A6157-M
	220	35,7 × 82,1	370	560	500	3,2	1,4	1,7	-A6227-M
	330	35,7 × 107,5	250	380	340	4,3	1,9	2,3	-A6337-M
	470	51,6 × 82,1	180	270	250	5,1	2,3	2,8	-A6477-M
	680	51,6 × 107,5	120	180	180	6,8	3,1	3,7	-A6687-M
	1 000	64,3 × 107,5	85	130	130	9	4,1	4,9	-A6108-M
	1 500	76,9 × 107,5	57	86	86	11	5,0	6,1	-A6158-M
	2 200	76,9 × 145,6	39	59	59	15	6,9	8	-A6228-M
	3 300	76,9 × 221,8	26	39	39	22	10	12	-A6338-M
	4 700	91,0 × 222,0	15	27	27	32	14	17	-A6478-M
	5 600	91,0 × 222,0	14	24	24	33	15	18	-A6568-M

**How to determine the ordering code**

To obtain the required ordering code, prefix the type number to the short code.

E.g.: B41564-A4109-Q, B43584-A227-M

$V_R = 16 \dots 100$ Vdc	B41564-... (ring clip mounting)	B41584-... (with threaded stud)
$V_R = 160 \dots 500$ Vdc	B43564-... (ring clip mounting)	B43584-... (with threaded stud)



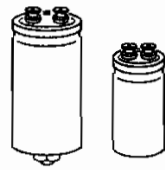

**Service life**

versus ambient temperature  $T_A$  under ripple current operating conditions<sup>1)</sup>

$V_R = 16 \dots 100 \text{ Vdc}$

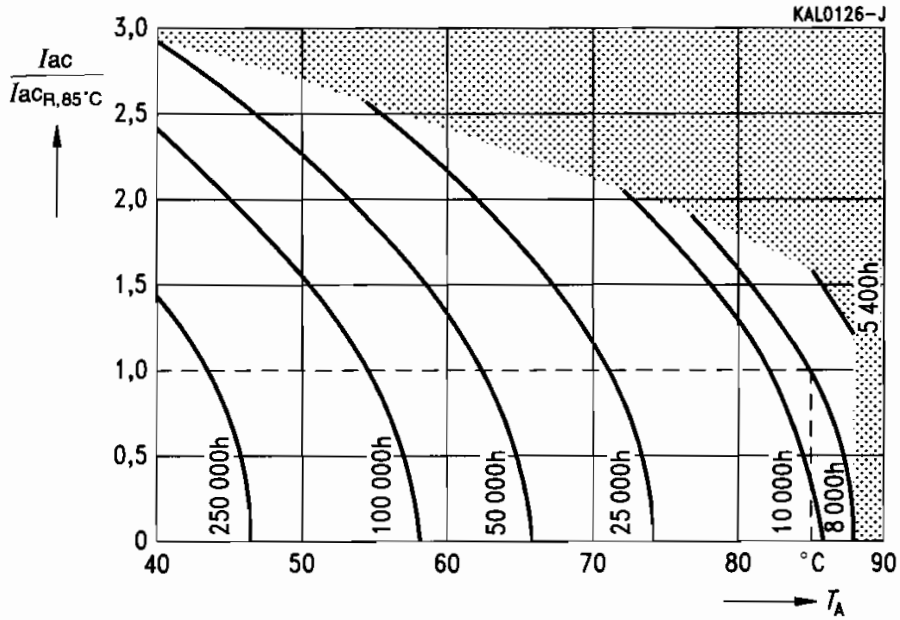

$V_R = 160 \dots 500 \text{ Vdc}$

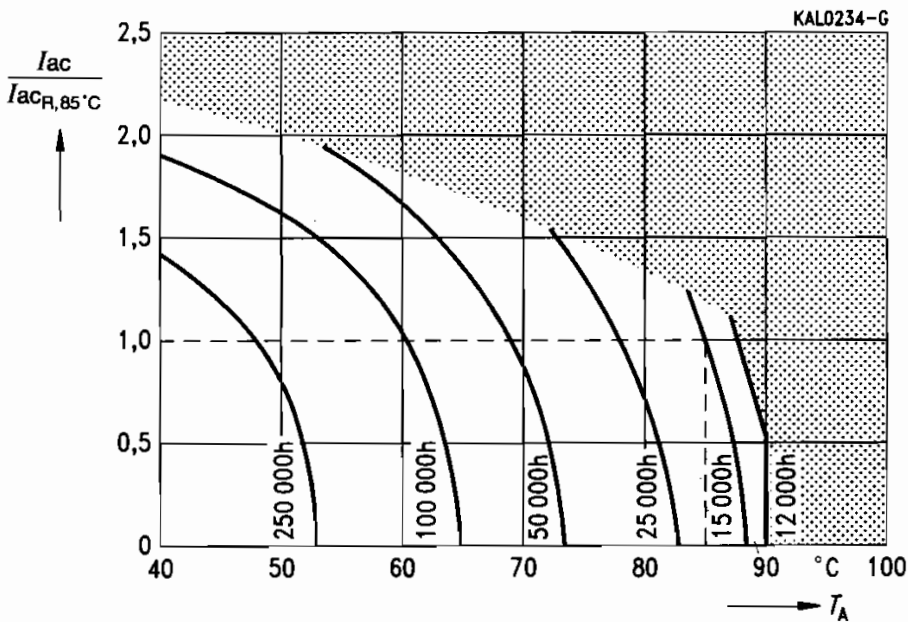

1) Refer to page 31 for an explanation on how to interpret the service life graphs.

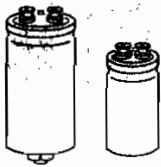

**B 41 564, B 41 584**  
**B 43 564, B 43 584**

**Permissible ripple current  $I_{ac}$**   
**versus frequency  $f$**

$V_R \leq 100 \text{ Vdc}$

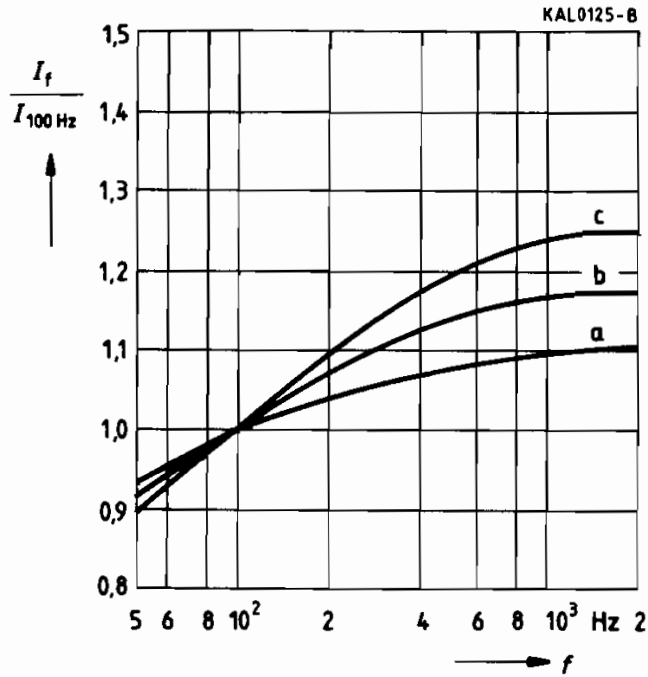

$V_R$ (Vdc)	16	25; 40	63	100
$d = 35,7 \text{ mm}$	a	a	b	c
$d \geq 51,6 \text{ mm}$	a	a	a	a

**Permissible ripple current  $I_{ac}$**   
**versus frequency  $f$**

$V_R \geq 160 \text{ Vdc}$

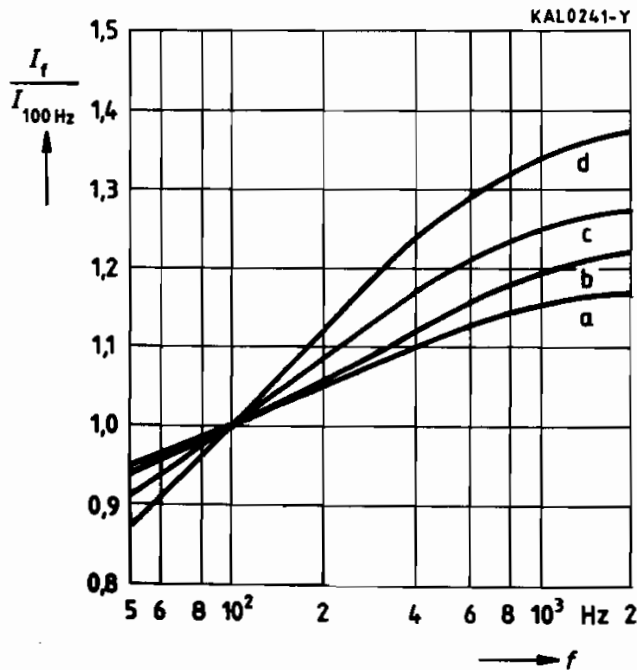

$d$ (mm)	35,7	51,6	64,3	76,9	91,0
Curve	d	c	b	a	c

**B 41 564, B 41 584**  
**B 43 564, B 43 584**

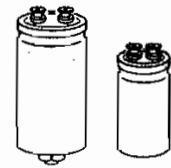

**Equivalent series resistance *ESR***  
 versus frequency *f*  
 Typical behavior  
 $V_R \leq 100$  Vdc

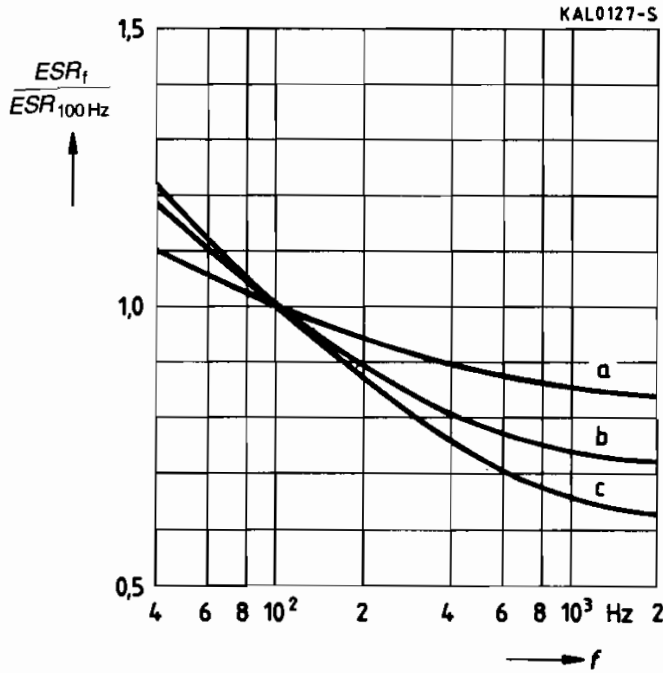

$V_R$ (Vdc)	16	25; 40	63	100
$d = 35,7$ mm	a	a	b	c
$d \geq 51,6$ mm	a	a	a	a

**Equivalent series resistance *ESR***  
 versus frequency *f*  
 Typical behavior  
 $V_R \geq 160$  Vdc

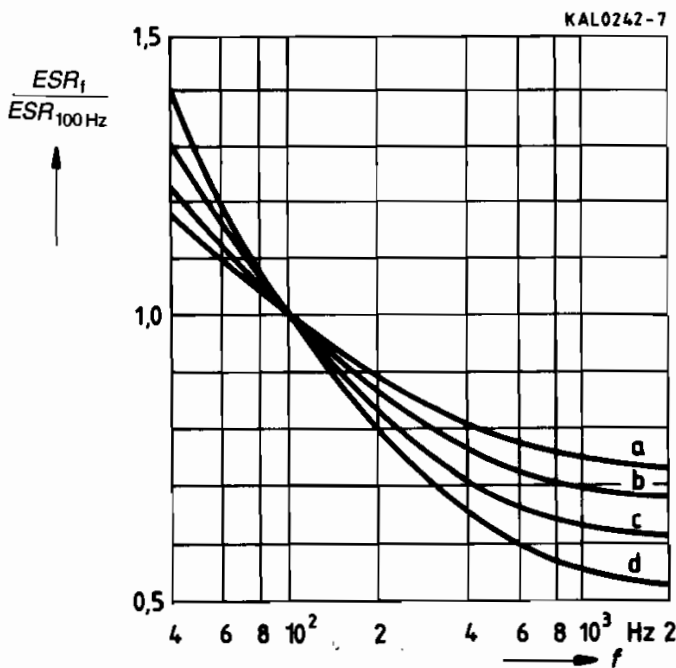

$d$ (mm)	35,7	51,6	64,3	76,9	91,0
Curve	d	c	b	a	a

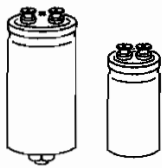

**B 41 564, B 41 584**  
**B 43 564, B 43 584**

**Impedance  $Z$**   
 versus frequency  $f$   
 Typical behavior  
 $V_R \leq 100$  Vdc

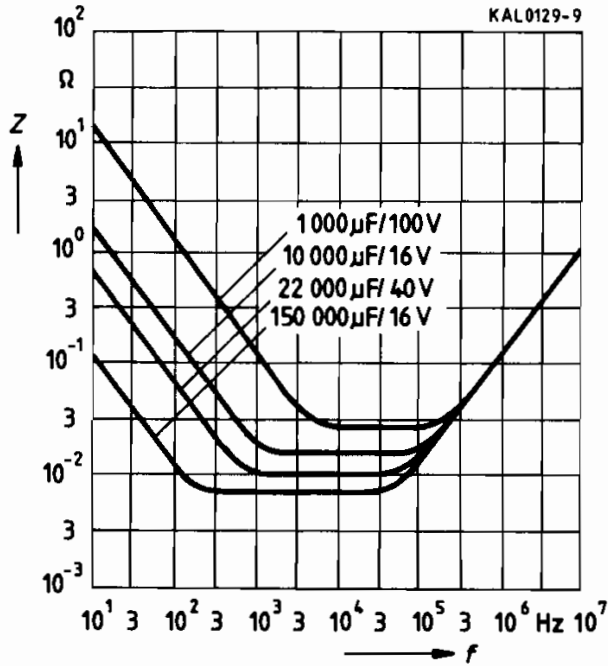

**Impedance  $Z$**   
 versus frequency  $f$   
 Typical behavior  
 $V_R \geq 160$  Vdc

