

Ceramic Capacitors (Safety Regulations) For Surface Mounting Types BC and FC

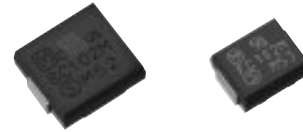

■ Features

- Resin molded SMD type for reflow soldering
- High reliability
- Safety requirement approved by UL, SEMKO, NEMKO, FIMKO, DEMKO and KTL (for Type FC)

■ Recommended Application

- Interference suppressors circuit and Isolation circuit of IT equipment such as MODEM.
- Interference suppressors circuit of small power supply machinery such as DC-DC converters and power modules.

■ Explanation of Part Numbers

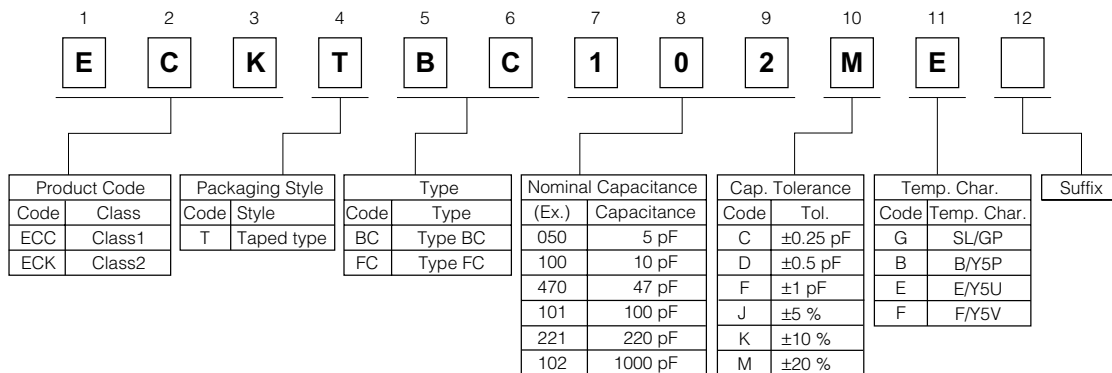

■ Construction

- Type BC, FC

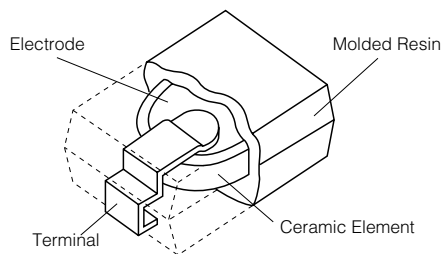

■ Dimensions in mm (not to scale)

- Type BC, FC

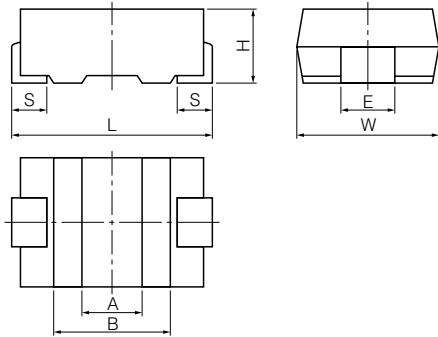

Symbol	L	W	H	S	E	A	B
Dim. Type BC	7.1±0.5	6.3±0.3	2.5±0.3	1.45±0.30	2.5±0.2	(2.0)	(3.7)
Type FC	5.7±0.5	4.5±0.3	2.3 max.	0.85±0.30	2.5±0.2	(1.7)	(3.1)

■ Specifications

Characteristics	Temp. Char. SL/GP	Temp. Char. B/Y5P, E/Y5U, F/Y5V										
Operating Temperature Range	-25 to 100 °C (-25 to 85 °C for UL approved)											
Rated Voltage	250 VAC											
Dielectric Withstanding Voltage	1500 VAC for 1 minute											
Capacitance	Within the specified tolerance, when measured at 1 MHz±20 %, 1 to 5 Vrms. and 20 °C	Within the specified tolerance, when measured at 1 kHz±20 %, 1 to 5 Vrms. and 20 °C										
Q or Dissipation Factor (tan δ)	30 pF or under Q ≥ 200+10 C (C:Cap.pF) over 30 pF Q ≥ 500 at 1 MHz±20 %, 1 to 5 Vrms. and 20 °C	tan δ ≤ 0.025 at 1 kHz±20 %, 1 to 5 Vrms. and 20 °C										
Insulation Resistance	10000 M Ω min. at 500 VDC and 1 minute electrification											
Temperature Characteristics	Temperature Coefficient: +350 to -1000 ppm/°C over the temperature range 20 to 85 °C	<table border="1"> <thead> <tr> <th>Char.</th> <th>Max. Cap. Change</th> <th>Temp. Range</th> </tr> </thead> <tbody> <tr> <td>B/Y5P</td> <td>±10 %</td> <td rowspan="3">-25 to 85 °C</td> </tr> <tr> <td>E/Y5U</td> <td>+20, -55 %</td> </tr> <tr> <td>F/Y5V</td> <td>+30, -80 %</td> </tr> </tbody> </table>	Char.	Max. Cap. Change	Temp. Range	B/Y5P	±10 %	-25 to 85 °C	E/Y5U	+20, -55 %	F/Y5V	+30, -80 %
Char.	Max. Cap. Change	Temp. Range										
B/Y5P	±10 %	-25 to 85 °C										
E/Y5U	+20, -55 %											
F/Y5V	+30, -80 %											

■ Related Standards and Certificate Number

Certification Body	Related Standard	Certificate Number		Sub-Class	Rated Voltage	Dielectric Withstanding Voltage	Operating Temperature Range
		Type BC	Type FC				
UL (USA)	UL1414*	E62674	—	—	250 VAC	1500 VAC	-25 to 85 °C
	UL1414 6th Ed.	—	E62674	Y2		2000 VAC	
	CSA C22.2 No.1*	E62674	—	—		1500 VAC	
SEMKO (Sweden)	EN132 400:1994 Sub-class Y2 (IEC 60384-14 2nd.Ed.)	0026049/01	0101074/01 0126276/01	Y2	250 VAC	1500 VAC	-25 to 100 °C
FIMKO (Finland)		—	FI 16588 FI 17348				
DEMKO (Denmark)		—	310914-01 310698-01				
NEMKO (Norway)		—	P01101830 P01100665				
KTL (Korea)		K60384-14 (IEC60384-14 2nd Ed.)	—				

Note : * is for Line-by-pass capacitors. Certification Number sometimes changes with the change of the approval contents and so on.
KTL mark is indicated on the label.

Design and specifications are each subject to change without notice. Ask factory for the current technical specifications before purchase and/or use.
Should a safety concern arise regarding this product, please be sure to contact us immediately.

■ Ratings and Characteristics

Type Name	Part Number	Capacitance (pF)	Cap. Tolerance	Temp. Char	Dimensions in mm
Type BC	ECCTBC100DG	10	±0.5 pF	SL/GP	7.1L×6.3W×2.5H
	ECCTBC150JG	15	±5 %	SL/GP	
	ECCTBC220JG	22	±5 %	SL/GP	
	ECCTBC330JG	33	±5 %	SL/GP	
	ECCTBC470JG	47	±5 %	SL/GP	
	ECCTBC680JG	68	±5 %	SL/GP	
	ECKTBC101KB	100	±10 %	B/Y5P	
	ECKTBC151KB	150	±10 %	B/Y5P	
	ECKTBC221KB	220	±10 %	B/Y5P	
	ECKTBC331KB	330	±10 %	B/Y5P	
	ECKTBC471KB	470	±10 %	B/Y5P	
	ECKTBC681KB	680	±10 %	B/Y5P	
	ECKTBC102ME	1000	±20 %	E/Y5U	
	ECKTBC152ME	1500	±20 %	E/Y5U	
ECKTBC222ME	2200	±20 %	E/Y5U		
Type FC	ECCTFC100DG	10	±0.5 pF	SL/GP	5.7L×4.5W×2.3H
	ECCTFC150JG	15	±5 %	SL/GP	
	ECCTFC220JG	22	±5 %	SL/GP	
	ECCTFC330JG	33	±5 %	SL/GP	
	ECKTFC470KB	47	±10 %	B/Y5P	
	ECKTFC680KB	68	±10 %	B/Y5P	
	ECKTFC101KB	100	±10 %	B/Y5P	
	ECKTFC151KB	150	±10 %	B/Y5P	
	ECKTFC221KB	220	±10 %	B/Y5P	
	ECKTFC331KB	330	±10 %	B/Y5P	
	ECKTFC471KB	470	±10 %	B/Y5P	
	ECKTFC102ME	1000	±20 %	E/Y5U	
	ECKTFC152MF	1500	±20 %	F/Y5V	
	ECKTFC222MF	2200	±20 %	F/Y5V	

Notes * Other capacitance values are available by special order.

■ Packaging Methods (Taping)

● Minimum Quantity/Packing Unit

Type	Packaging style	Part Number	Minimum Packing Quantity	Packing Quantity in Carton	Carton Dimensions in mm (LxWxH)
Type BC	Embossed Carrier Taping	EC□TBC□□□□□□	10 to 2200 pF	2000 pcs./reel	6000 pcs. 350×350×62
Type FC	Embossed Carrier Taping	EC□TFC□□□□□□	10 to 2200 pF	3000 pcs./reel	9000 pcs. 350×350×62

● Reel

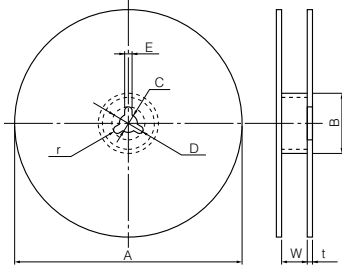

Symbol	A	B	C	D	E	W	t	r
Dim. (mm)	330±5	60 min.	13.0±0.5	21.0±1.0	2.0±0.5	13.5±1.5	2.0±0.5	R1.0

Unit: (mm)

● Embossed carrier taping

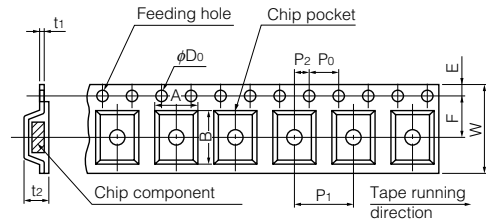

Symbol	A	B	W	F	E	P1	P2	P0	ϕD_0	t1	t2	
Dim. (mm)	Type BC	6.5 ±0.2	7.5 ±0.2	12.0 ±0.3	5.5 ±0.1	1.75 ±0.10	8.0 ±0.1	2.00 ±0.05	4.0 ±0.1	1.5 +0.1 -0	0.3 ±0.1	3.2 ±0.3
	Type FC	4.8 ±0.2	6.0 ±0.2									2.8 ±0.3

Unit: (mm)

● Leader Part and Taped End

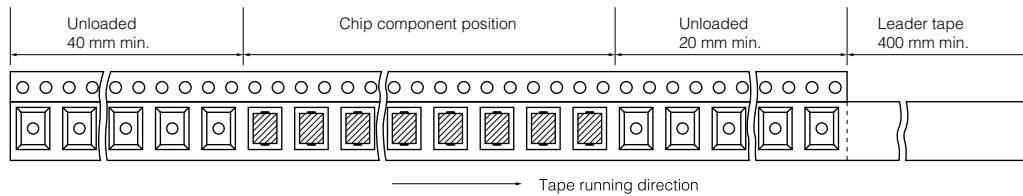

■ Typical Characteristics

● Temperature Characteristics

Char. SL/GP

(Temp. Coeff.: +350 to -1000 ppm/°C)

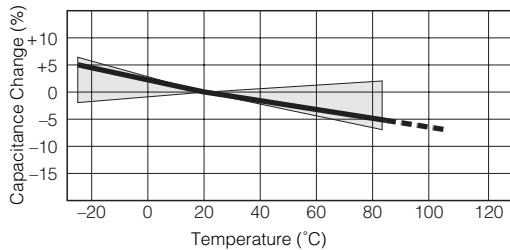

Char. B/Y5P

Temp. Range: -25 to 85 °C

Max. Cap. Change: ±10 %

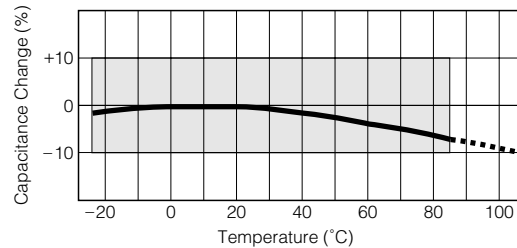

Char. E/Y5U

(Temp. Range: -25 to 85 °C
max. Cap. Change: +20, -55 %)

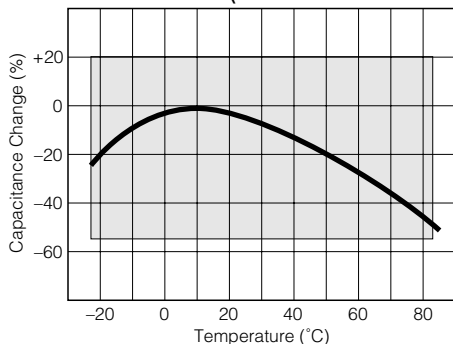

Char. F/Y5V

(Temp. Range: -25 to 85 °C
max. Cap. Change: +30, -80 %)

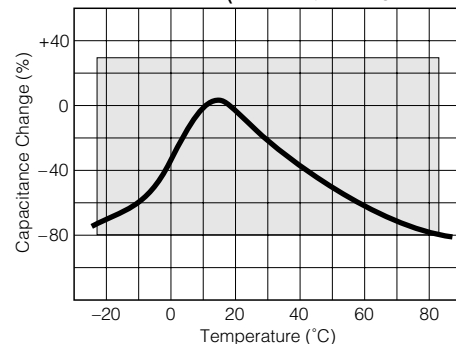

Typical Characteristics

Impedance vs. Frequency Characteristics

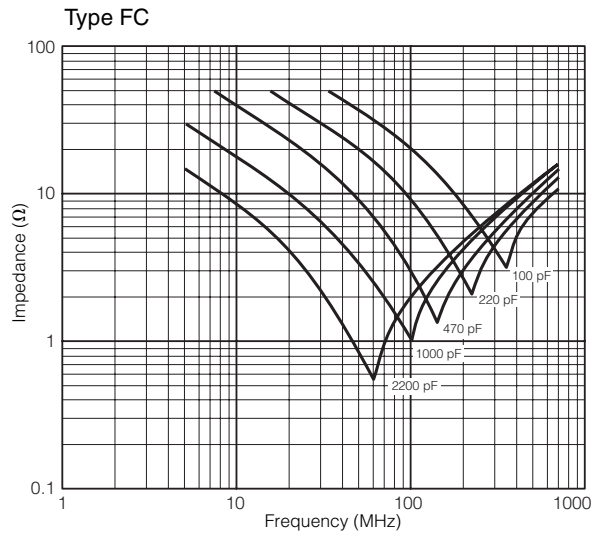
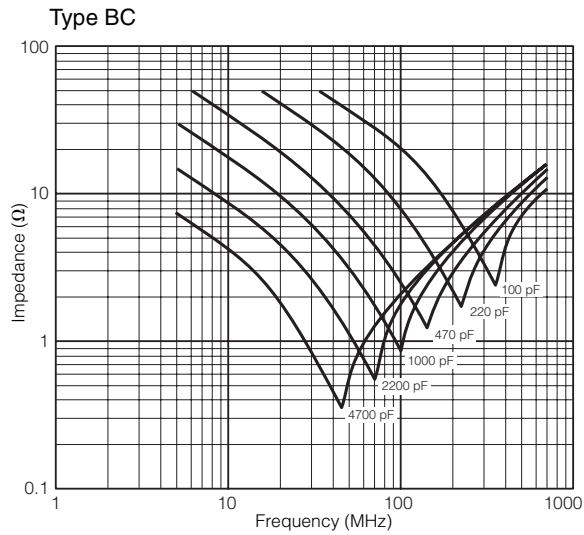

Current vs. Voltage (Leakage Current Characteristics)

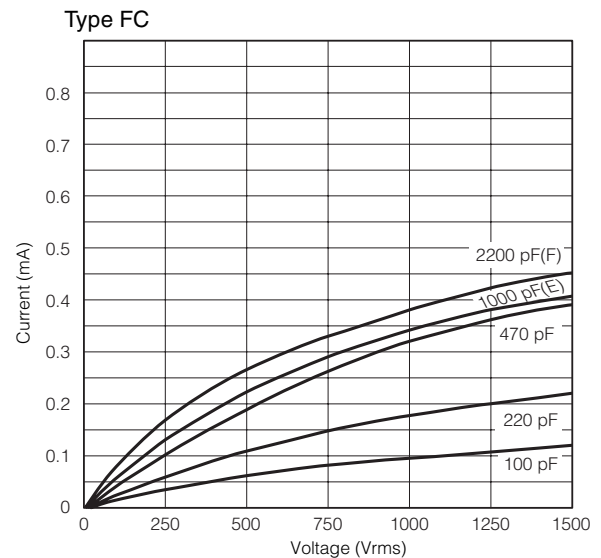
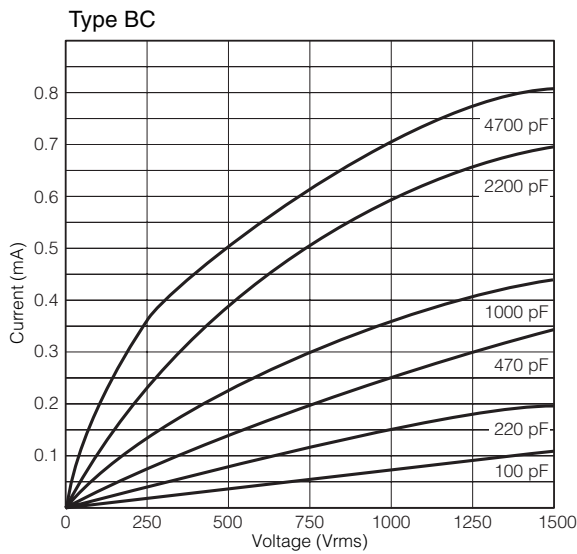

Application Examples

MODEM

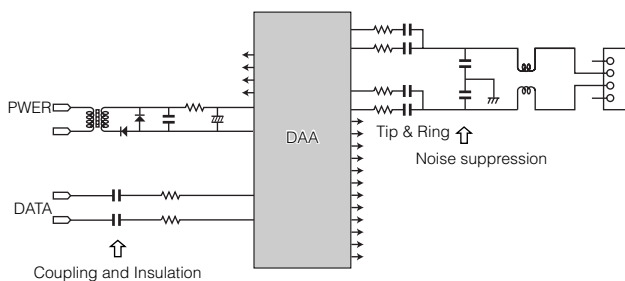

Primary circuit of Switching Power Supply

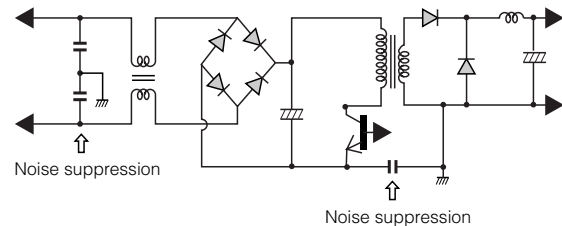

Design and specifications are each subject to change without notice. Ask factory for the current technical specifications before purchase and/or use. Should a safety concern arise regarding this product, please be sure to contact us immediately.