

Type MLP, 85 °C Flatpack, Ultra-Long Life, Aluminum

Type MLP 85 °C

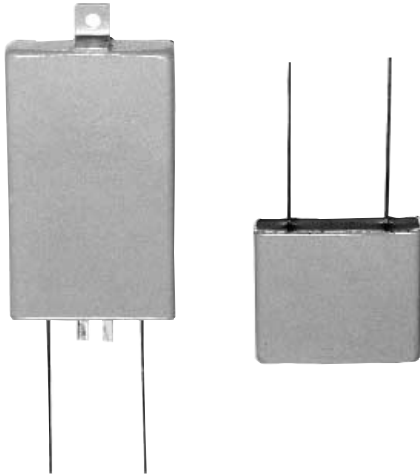

1/2-Inch Height, 50-Year Life

The MLP's high-energy storage and box-shape make it perfect for voltage holdup or filtering in military SEM-E modules, telecom circuit packs and computer cards. The MLP delivers 25 joules of energy storage in a 1/2" height with 50 year's life at +45 °C. You can readily heatsink it to double the ripple-current capability. Ratings up to 250 V can operate at 75% of rated voltage up to 125 °C if clamped or potted to prevent expanding beyond 1/2".

Highlights

- w Low-profile replacement for snap-ins
- w Double the ripple capability with a heatsink
- w Near-hermetic welded seal assures 50-year life

Specifications

Operating Temperature: -55 °C to +85 °C up to 250 Vdc, -40 °C to 85 °C 300 Vdc & up
Rated Voltage: 7.5 to 450 Vdc
Capacitance: 110 μF to 47,000 μF ±20%
Leakage Current: ≤ 0.002 CV μA @ 25 °C and 5 min
Cold Impedance: -55 °C multiple of 25 °C Z ≤ 4 for 7.5 V, 2 for 10 V to 250 V
 -20 °C multiple of 25 °C Z ≤ 4 for 300 V and up

Ripple Current Multipliers:

Case Temperature

45 °C	55 °C	65 °C	75 °C	85 °C
3.79	3.32	2.77	2.08	1.00

Ambient Temperature, No Heatsink

45 °C	55 °C	65 °C	75 °C	85 °C
1.00	0.90	0.75	0.56	0.27

Frequency

	50 Hz	60 Hz	120 Hz	360 Hz	1 kHz	5 kHz	10 kHz & up
7.5 to 63 V	.94	.95	1.00	1.04	1.05	1.06	1.06
80 to 420 V	.80	.85	1.00	1.17	1.24	1.28	1.29

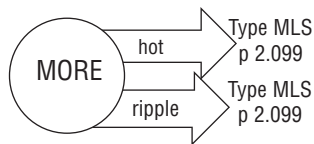

Load Life: 2,000 h @ +85 °C, Δ Capacitance ±10%, ESR 200% of limit, DCL 100% of limit, height 0.5 in. max
Shelf Life: 500 h at 85 °C, capacitance, ESR and DCL, initial requirements. Height 0.5 in max
Thermal Resistance: Maximum core temperature 88 °C
 Core to Case, bare can 1.1 °C/W
 Core to Case, insulated 1.6 °C/W
Vibration: 10 Hz to 2 kHz, 0.06" pp max and 10 g, MIL-STD-202, Meth. 204
ESL: <30 nH measured 1/4" from case at 1 MHz
Weight: Case EK 30g max.
 Case EB 66g max.

Aluminum Radial Leaded Capacitors

Type MLP, 85 °C Flatpack, Ultra-Long Life, Aluminum

Specifications

Double the Ripple Current: Attach the MLP to an external heatsink and you can easily double the ripple current capability and assure long life through cooler operation. The broad, flat top and bottom on the MLP are ideal for cooling the capacitor and removing the heat caused by ripple current.

Ripple Current Capability is set by the maximum permissible internal core temperature, 88 °C. This assures that the case does not inflate beyond 0.5 inch height.

Air Cooled. The ripple currents in the ratings tables are for 85°C case temperatures. For air temperatures without a heatsink use the multipliers **Ambient Temperature, No Heatsink.**

Heatsink Cooled. Temperature rise from the internal hottest spot, the core, to ambient air is:

$$\Delta T = I^2(ESR)(\theta_{cc} + \theta_{ca})$$

where θ_{cc} is the thermal resistance from core to case and θ_{ca} from case to ambient. To calculate maximum ripple capability with the MLP attached to a heatsink use the maximum core temperature and the values for θ_{cc} .

As an illustration, suppose you operate an insulated MLP in 65 °C air and attach it to a commercial heatsink with a free-air thermal resistance of 2.7 °C/W. Use a good thermal grease between the MLP and the heatsink, and the total thermal resistance is 2.7 + 1.6 or 4.3 °C/W. The power which would heat the core to 88 °C is (88-65)/4.3 or 5.35 W. For an ESR of 100 mΩ, 5.35 W equates to a ripple current of 6.5A.

Outline Drawings

Aluminum Radial Leaded Capacitors

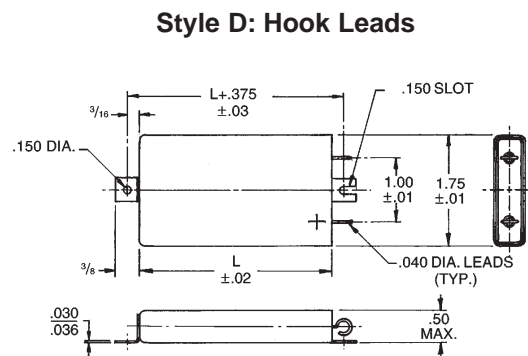
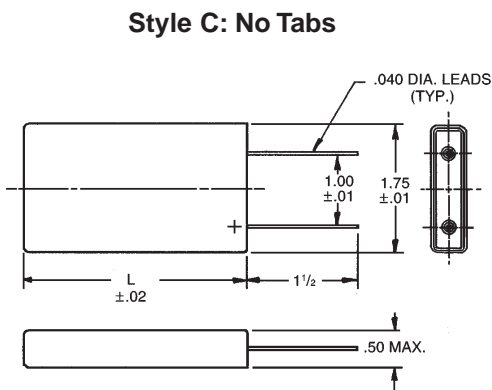
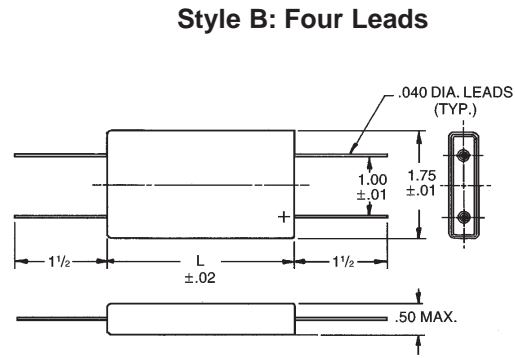
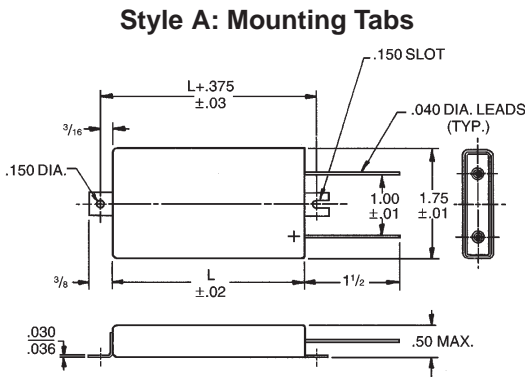

Case Code	L Length	Weight g
EK	1.50	30
EB	3.00	66

Type MLP, 85 °C Flatpack, Ultra-Long Life, Aluminum

Part Numbering System

MLP	102	M	200	EB	0	A
Type	Capacitance	Tolerance	Rated Voltage	Case Code	Insulation	Mounting Style
MLP	821=820 μ F 102=1000 μ F	M = \pm 20%	Vdc	EK, L = 1.5 in. EB, L = 3.0 in.	0 = bare can 1 = polyester	A = mounting tabs B = four leads C = two leads/no tabs D = hook leads/tabs E = hook leads/no tabs

Typical Performance Curves

Impedance vs. Frequency and Temperature
47,000 μ F 7.5 VDC

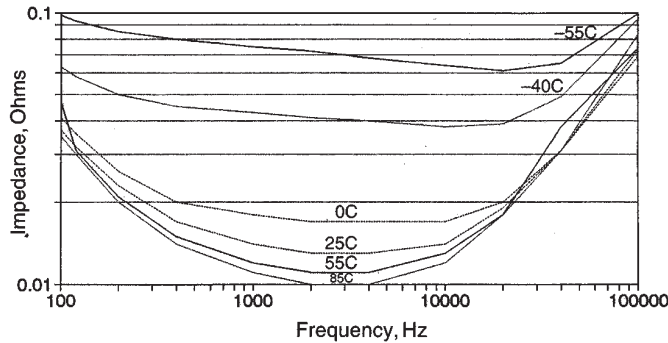

Impedance vs. Frequency and Temperature
47,000 μ F 75 VDC

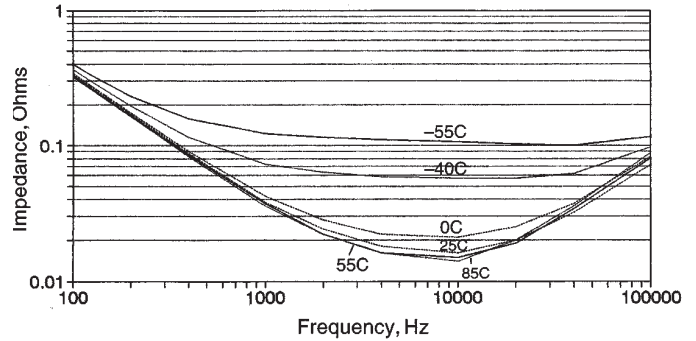

Note: Impedance measured at ends of leads.

MLP 4400 μ F 50 V Life Test 85°C

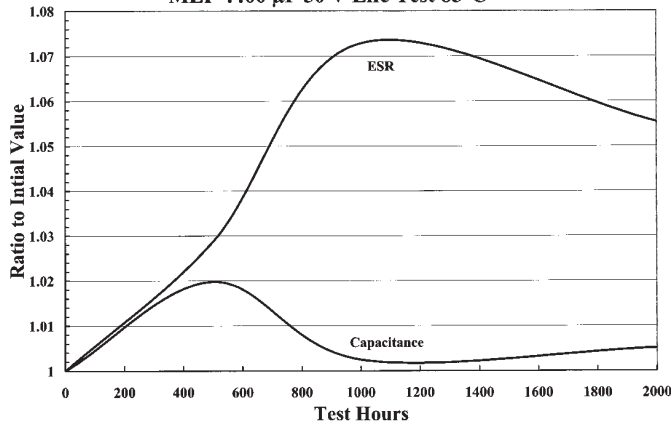

MLP 300 μ F 400 V Life Test 105°C

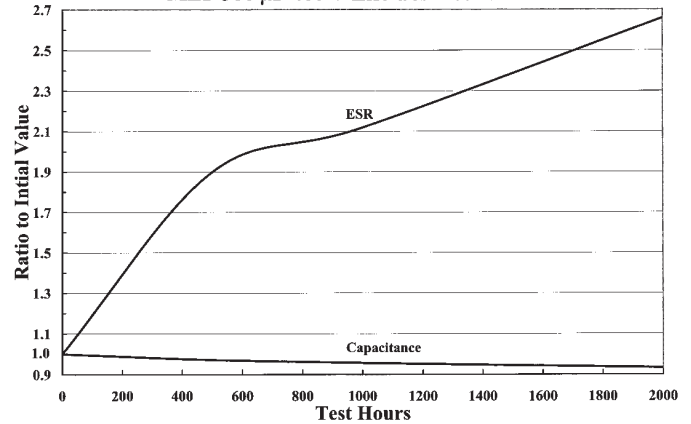

MLP 4400 μ F 50V Ripple Life Test 85°C

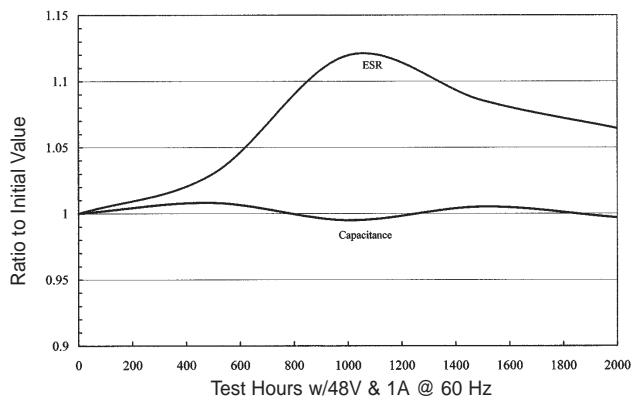

MLP 300 μ F 400V Ripple Life Test 85°C

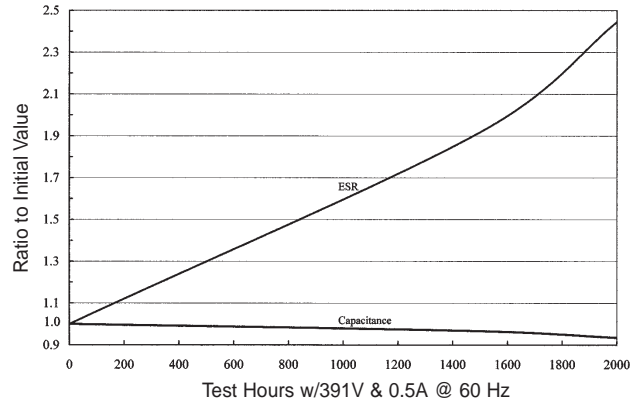

Aluminum Radial Leaded Capacitors

Type MLP, 85 °C Flatpack, Ultra-Long Life, Aluminum

Typical Performance Curves

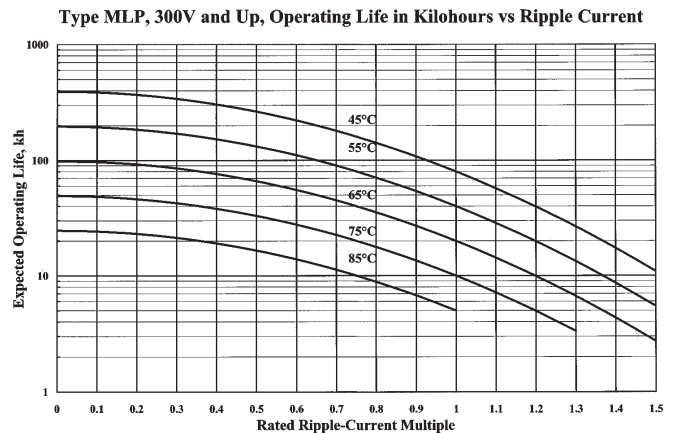
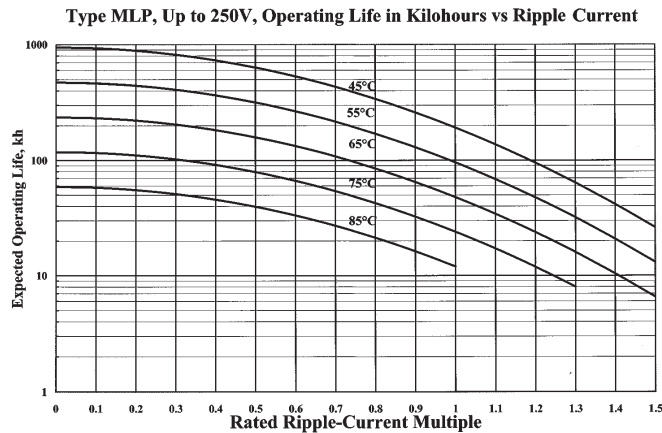

Ratings

Cap. μF	Catalog Number	ESR max mΩ		Ripple Amps Max. @ 85 °C		Case Code
		120 Hz	20 kHz	120 Hz	20 kHz	
7.5 Vdc (10 Vdc Surge)						
19,000	MLP193M7R5EK0A	76	66	4.2	4.5	EK
47,000	MLP473M7R5EB0A	30	26	9.1	9.8	EB
10 Vdc (13 Vdc Surge)						
17,000	MLP173M010EK0A	77	67	4.2	4.5	EK
43,000	MLP433M010EB0A	31	27	9.0	9.6	EB
16 Vdc (20 Vdc Surge)						
13,000	MLP133M016EK0A	81	69	4.1	4.4	EK
38,000	MLP383M016EB0A	31	27	9.0	9.6	EB
20 Vdc (25 Vdc Surge)						
9,600	MLP962M020EK0A	84	69	4.0	4.4	EK
24,000	MLP243M020EB0A	33	27	8.7	9.6	EB
25 Vdc (30 Vdc Surge)						
8,000	MLP802M025EK0A	87	69	3.9	4.4	EK
20,000	MLP203M025EB0A	34	27	8.6	9.6	EB
35 Vdc (50 Vdc Surge)						
5,600	MLP562M035EK0A	90	70	3.4	4.4	EK
14,000	MLP143M035EB0A	35	27	8.4	9.6	EB
50 Vdc (63 Vdc Surge)						
4,400	MLP442M050EK0A	97	70	3.7	4.4	EK
11,000	MLP113M050EB0A	36	27	8.3	9.6	EB
63 Vdc (75 Vdc Surge)						
2,200	MLP222M063EK0A	101	76	3.7	4.2	EK
5,600	MLP562M063EB0A	36	29	8.3	9.3	EB
80 Vdc (100 Vdc Surge)						
1,500	MLP152M080EK0A	106	77	3.6	4.2	EK
3,300	MLP332M080EB0A	44	31	7.5	9.0	EB

Cap. μF	Catalog Number	ESR max mΩ		Ripple Amps Max. @ 85 °C		Case Code
		120 Hz	20 kHz	120 Hz	20 kHz	
100 Vdc (125 Vdc Surge)						
1,100	MLP112M100EK0A	112	78	3.5	4.2	EK
2,700	MLP272M100EB0A	46	33	7.4	8.7	EB
150 Vdc (180 Vdc Surge)						
500	MLP501M150EK0A	355	248	1.9	2.3	EK
1,300	MLP132M150EB0A	143	100	4.2	5.0	EB
200 Vdc (250 Vdc Surge)						
400	MLP401M200EK0A	388	253	1.9	2.3	EK
1,000	MLP102M200EB0A	158	100	3.8	5.0	EB
250 Vdc (300 Vdc Surge)						
330	MLP331M250EK0A	426	258	1.8	2.3	EK
820	MLP821M250EB0A	172	103	3.8	4.9	EB
300 Vdc (350 Vdc Surge)						
220	MLP221M300EK0A	597	393	1.5	1.9	EK
560	MLP561M300EB0A	240	157	3.2	4.0	EB
350 Vdc (400 Vdc Surge)						
150	MLP151M350EK0A	1000	735	1.2	1.4	EK
370	MLP371M350EB0A	420	310	2.3	2.8	EB
400 Vdc (450 Vdc Surge)						
130	MLP131M400EK0A	1320	970	1.0	1.2	EK
330	MLP331M400EB0A	530	390	2.1	2.5	EB
420 Vdc (475 Vdc Surge)						
130	MLP131M420EK0A	1320	970	1.0	1.2	EK
330	MLP331M420EB0A	530	390	2.1	2.5	EB
450 Vdc (500 Vdc Surge)						
110	MLP111M450EK0A	1456	1190	.96	1.1	EK
280	MLP281M450EB0A	585	480	2.0	2.3	EB

Aluminum Radial Leaded Capacitors

Type MLS, 125 °C Stainless Flatpack, Ultra-Long Life, Aluminum

Type MLS 125 °C

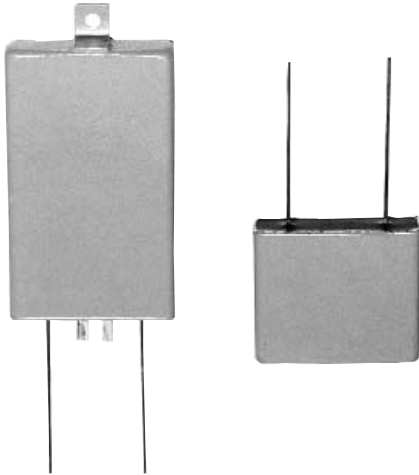

The Type MLS extends the super performance of the MLP from a maximum operating temperature of 85 °C to 125 °C. While the MLP is inherently capable of operation at 125 °C, its flat aluminum case can't withstand the higher temperature without inflating from internal pressure. The MLS incorporates a rugged, stainless steel case which assures flatness to beyond 125 °C. The MLS is perfect for hi-rel military systems and applications operating above 85 °C.

Highlights

- w Near-hermetic welded seal
- w Stainless-steel case
- w 100 years expected operating life

Specifications

Operating Temperature:	-55 °C to +125 °C
Rated Voltage:	5.0 to 250 Vdc
Capacitance:	220 to 47,000 $\mu\text{F} \pm 20\%$
Load Life:	2,000 h @ +125 °C
Leakage Current:	0.002 CV μA @ 25 °C and 5 min
Cold Impedance:	-55 °C multiple of 25 °C $Z \leq 4$ for 5 V, 2 for 7.5 V and up
Ripple Current Multipliers:	Case Temperature

45 °C	55 °C	65 °C	75 °C	85 °C	95 °C	105 °C	115 °C	125 °C
1.41	1.32	1.22	1.12	1.00	0.87	0.71	0.50	0.00

Ambient Temperature, No Heatsink

45 °C	55 °C	65 °C	75 °C	85 °C	95 °C	105 °C	115 °C	125 °C
0.63	0.58	0.54	0.49	0.44	0.38	0.31	0.22	0.00

Frequency

	50 Hz	60 Hz	120 Hz	360 Hz	1 kHz	5 kHz	10 kHz & up
5 to 40 V	.95	.96	1.00	1.03	1.04	1.04	1.04
60 to 250 V	.80	.84	1.00	1.18	1.25	1.30	1.30

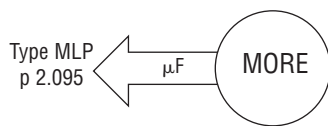

EIA Ripple Life:	10,000 h full load at 85 °C per EIA IS-749 Δ capacitance $\pm 10\%$ ESR 200% of limit DCL 100% of limit
Shelf Life:	500 h at 125 °C, capacitance, ESR & DCL, initial requirements
Thermal Resistance:	Maximum core temperature 125 °C Core to Case, bare can 3.4 °C/W Core to Case, insulated 3.9 °C/W
Vibration:	10 Hz to 2 kHz 0.06" pp max and 10 g, MIL-STD-202, Meth. 204
ESL:	< 30 nH measured 1/4" from case at 1 MHz
Weight:	Case EK 43g max. Case EB 88g max.

Aluminum Radial Leaded Capacitors

Type MLS, 125 °C Stainless Flatpack, Ultra-Long Life, Aluminum

Specifications

Ripple Current Capability is set by the maximum permissible internal core temperature, 125 °C.

Air Cooled. The ripple currents in the ratings tables are for 85°C case temperatures. For air temperatures without a heatsink use the Ambient Temperature, No Heatsink multipliers.

Heatsink Cooled. Temperature rise from the internal hottest spot, the core, to ambient air is:

$$\Delta T = I^2(ESR)(\theta_{cc} + \theta_{ca})$$

where θ_{cc} is the thermal resistance from core to case and θ_{ca} from case to ambient. To calculate maximum ripple

capability with the MLP attached to a heatsink use the maximum core temperature and the values for θ_{cc} .

As an illustration, suppose you operate an insulated MLS in 65 °C air and attach it to a commercial heatsink with a free-air thermal resistance of 2.7 °C/W. Use a good thermal grease between the MLS and the heatsink, and the total thermal resistance is 2.7 + 3.9 or 6.6 °C/W. The power which would heat the core to 125 °C is (125-65)/6.6 or 9.09W. For an ESR of 100 mΩ, 9.09W equates to a ripple current of 9.5A.

Outline Drawings

Style A: Mounting Tabs

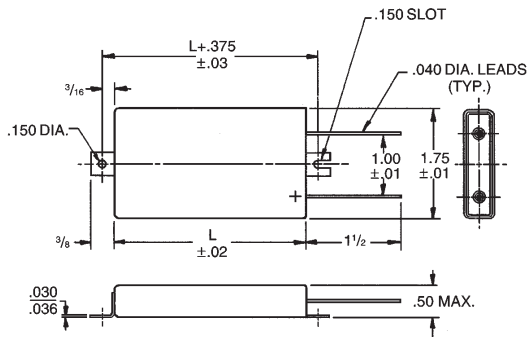

Case Code	L Length	Weight g
EK	1.50	43
EB	3.00	88

Style C: No Tabs

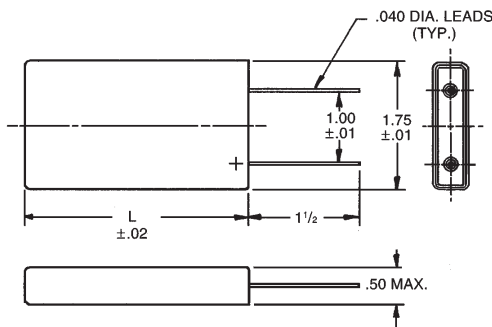

Style D: Hook Leads

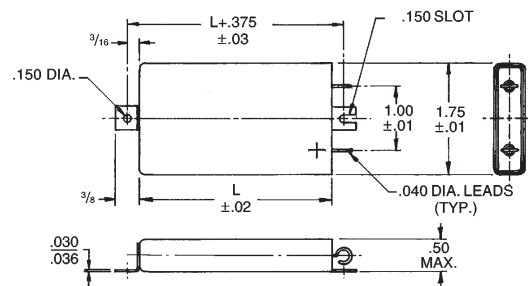

Aluminum Radial Leaded Capacitors

Type MLS, 125 °C Stainless Flatpack, Ultra-Long Life, Aluminum

Part Numbering System

MLS	821	M	200	EB	0	A
Type MLS	Capacitance 821=820 μ F 102=1000 μ F	Tolerance M = \pm 20%	Rated Voltage Vdc	Case Code EK, L = 1.5 in. EB, L = 3.0 in.	Insulation 0 = bare can 1 = polyester	Mounting Style A = mounting tabs C = two leads/no tabs D = hook leads/tabs E = hook leads/no tabs

Typical Performance Curves

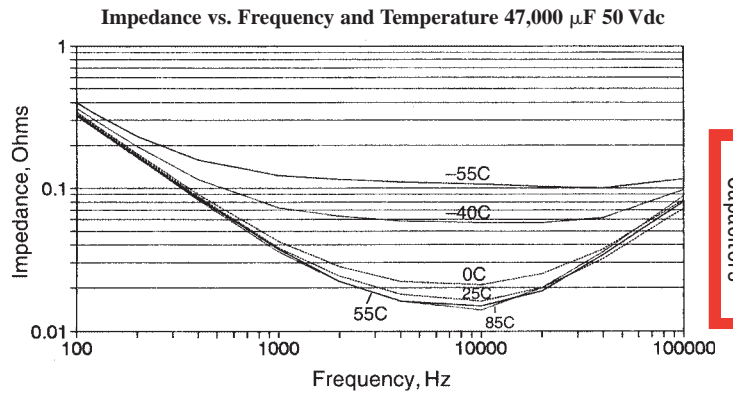
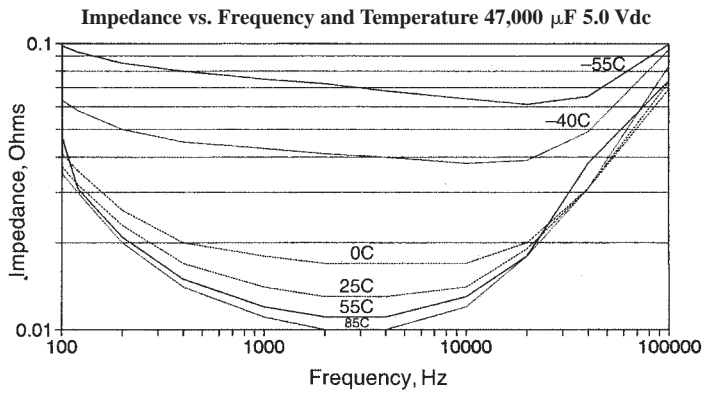

Aluminum Radial Leaded Capacitors

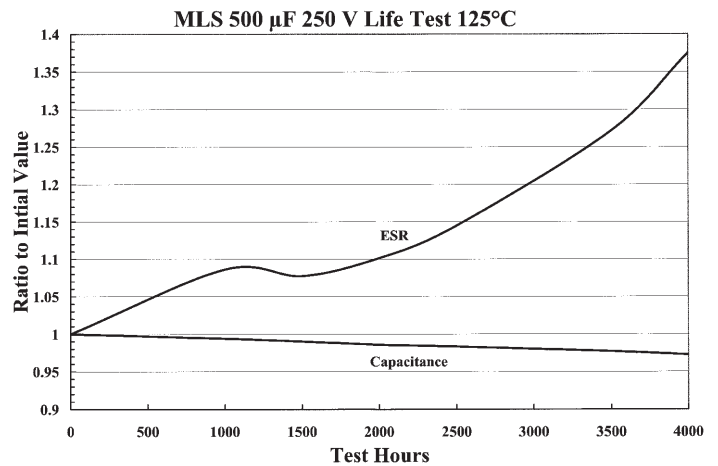
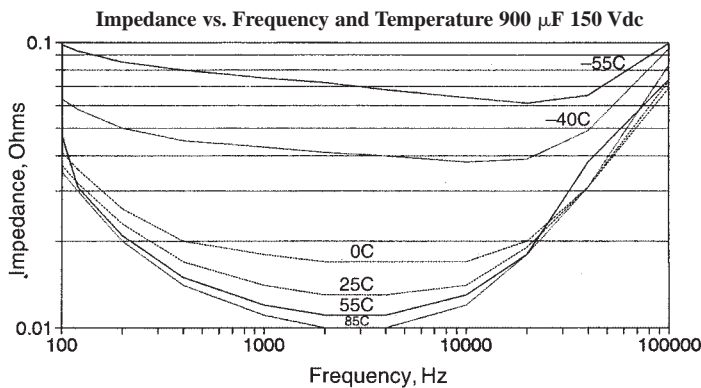

Type MLS, 125 °C Stainless Flatpack, Ultra-Long Life, Aluminum

Typical Performance Curves

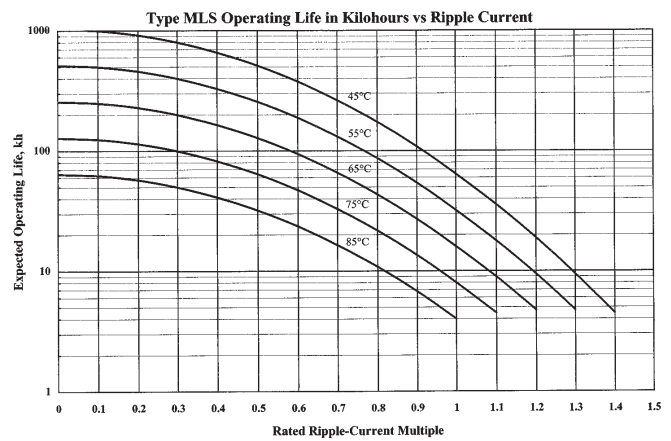
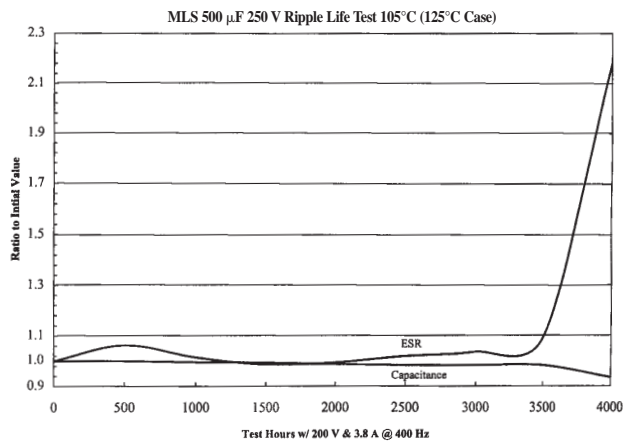

Ratings

Cap. µF	Catalog Number	ESR max mΩ		Ripple Amps Max. @ 85 °C		Case Code
		120 Hz	20 kHz	120 Hz	20 kHz	
5 Vdc (7.5 Vdc Surge)						
19,000	MLS193M5R0EK0C	76	66	11.6	12.5	EK
47,000	MLS473M5R0EB0C	30	26	18.5	19.9	EB
7.5 Vdc (10 Vdc Surge)						
17,000	MLS173M7R0EK0C	77	67	11.5	12.4	EK
43,000	MLS433M7R0EB0C	31	27	18.2	19.5	EB
10 Vdc (15 Vdc Surge)						
13,000	MLS133M010EK0C	81	69	11.3	12.2	EK
38,000	MLS383M010EB0C	31	27	18.2	19.5	EB
20 Vdc (30 Vdc Surge)						
6,800	MLS682M020EK0C	84	69	11.0	12.2	EK
17,000	MLS173M020EB0C	33	27	17.6	19.5	EB
40 Vdc (50 Vdc Surge)						
4,400	MLS442M040EK0C	97	70	10.3	12.1	EK
11,000	MLS113M040EB0C	36	27	16.9	19.5	EB
60 Vdc (75 Vdc Surge)						
1,500	MLS152M060EK0C	106	77	9.8	11.5	EK
3,300	MLS332M060EB0C	44	31	15.3	18.2	EB
75 Vdc (100 Vdc Surge)						
1,100	MLS112M075EK0C	112	78	9.6	11.5	EK
2,700	MLS272M075EB0C	46	33	14.9	17.6	EB

Cap. µF	Catalog Number	ESR max mΩ		Ripple Amps Max. @ 85 °C		Case Code
		120 Hz	20 kHz	120 Hz	20 kHz	
100 Vdc (125 Vdc Surge)						
500	MLS501M100EK0C	355	248	5.4	6.4	EK
1,300	MLS132M100EB0C	143	100	8.5	10.1	EB
150 Vdc (175 Vdc Surge)						
400	MLS401M150EK0C	388	253	5.1	6.4	EK
1,000	MLS102M150EB0C	158	100	8.1	10.1	EB
200 Vdc (225 Vdc Surge)						
330	MLS331M200EK0C	426	258	4.9	6.3	EK
820	MLS821M200EB0C	172	103	7.7	10.0	EB
250 Vdc (275 Vdc Surge)						
220	MLS221M250EK0C	597	393	4.1	5.1	EK
560	MLS561M250EB0C	240	157	6.5	8.1	EB

Aluminum Radial Leaded Capacitors