



Aluminum electrolytic capacitors

Axial-lead and soldering star capacitors

Series/Type: B41694, B41794

Date: November 2008

Applications

- For automotive applications with high EMV requirements

Features

- Very high ripple current capability
- Very low ESR at temperatures down to -55 °C
- High vibration resistance
- High reliability of 1000 h at up to 140 °C
- Shelf life up to 15 years at storage temperatures up to 40 °C .
To ensure solderability, the capacitors should be built into the application within one year of delivery. After a total of two years' storage, the operating voltage must be applied for one hour to ensure the specified leakage current.

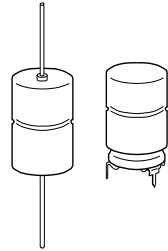

Construction

- Charge/discharge-proof, polar
- Aluminum case with insulating sleeve
- Negative pole connected to case

Terminals

- Axial leads, welded to ensure perfect electrical contact
- Also available with soldering stars

Taping and Packing

- Axial-lead capacitors will be delivered in pallet package.
Capacitors with $d \times l \leq 16 \times 30\text{ mm}$ are also available taped on reel.
- Soldering star capacitors are packed in cardboard.

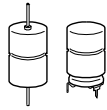
Specifications and characteristics in brief

| | | | | | | | |
|---|--|---|----|----|----|-------|------------------|
| Rated voltage V_R | 25 and 40 V DC | | | | | | |
| Surge voltage V_S | $1.15 \cdot V_R$ | | | | | | |
| Rated capacitance C_R | 330 ... 3900 μ F | | | | | | |
| Capacitance tolerance | -10/+30% \triangle Q | | | | | | |
| Leakage current I_{leak} (5 min, 20 °C) | $I_{leak} \leq 0.006 \mu A \cdot \left(\frac{C_R}{\mu F} \cdot \frac{V_R}{V} \right) + 4 \mu A$ | | | | | | |
| Self-inductance ESL ¹⁾ | Diameter d (mm) | 12 | 14 | 16 | 18 | 20/21 | |
| | Terminals | Length l (mm) | | | | | Approx. ESL (nH) |
| | axial | 25 | – | 22 | 26 | – | – |
| | | 29 | – | – | – | – | 38 |
| | | 30 | 21 | 24 | 29 | 34 | – |
| | | 39 | – | – | 33 | 38 | 45 |
| | | 49 | – | – | – | – | 50 |
| | soldering star | 25 | – | 6 | 7 | – | – |
| | | 30 | 6 | 7 | 8 | 10 | – |
| 39 | | – | – | 9 | 11 | – | |
| Useful life 140 °C; V_R ; $I_{AC,R}$ 125 °C; V_R ; $I_{AC,R}$ 85 °C; V_R ; $I_{AC,max}$ 40 °C; V_R ; $2.1 \cdot I_{AC,R}$ | > 1000 h | Requirements: $\Delta C/C \leq \pm 30\%$ of initial value ESR ≤ 3 times initial specified limit $I_{leak} \leq$ initial specified limit | | | | | |
| | > 3000 h | | | | | | |
| | > 8000 h | | | | | | |
| | > 200000 h | | | | | | |
| Voltage endurance test 125 °C; V_R | 2000 h | Post test requirements: $\Delta C/C \leq \pm 10\%$ of initial value ESR $\leq 1.3\%$ initial specified limit $I_{leak} \leq$ initial specified limit | | | | | |
| | | Vibration resistance test To IEC 60068-2-6, test Fc: Displacement amplitude 1.5 mm, at 10 Hz ... 2 kHz, acceleration max. 20 g, duration 3 \times 2 h. Capacitor mounted by its wire leads at a distance of (6 \pm 1) mm from the case and additionally clamped by the case. | | | | | |
| IEC climatic category | To IEC 60068-1: 55/125/56 (–55 °C/+125 °C/56 days damp heat test) | | | | | | |
| Detail specification | Similar to CECC 30301-802 | | | | | | |
| Sectional specification | IEC 60384-4 | | | | | | |

1) If optimum circuit design is used, the values are lower by 30%.

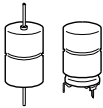

B41694, B41794

Low ESR – up to 140 °C

Axial-lead capacitors

Dimensional drawing

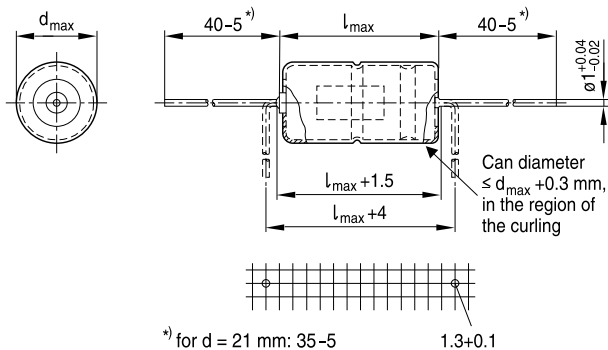

KAL0524-S-E

Dimensions, weights and packing units

| $d \times l$ mm | $d_{\max} \times l_{\max}$ mm | Approx. weight g | Packing units (pcs.) | |
|--------------------|----------------------------------|---------------------|----------------------|------|
| | | | Pallet | Reel |
| 12 × 30 | 12.5 × 30.5 | 5.1 | 288 | 450 |
| 14 × 25 | 14.5 × 25.5 | 5.7 | 200 | 350 |
| 14 × 30 | 14.5 × 30.5 | 6.8 | 200 | 350 |
| 16 × 30 | 16.5 × 30.5 | 8.9 | 180 | 250 |
| 16 × 39 | 16.5 × 40 | 11.7 | 180 | — |
| 18 × 30 | 18.5 × 30.5 | 11.1 | 160 | — |
| 18 × 39 | 18.5 × 40 | 14.7 | 160 | — |
| 20 × 29 | 20.5 × 29.5 | 13.5 | 140 | — |
| 21 × 39 | 21.5 × 40 | 20.0 | 140 | — |
| 21 × 49 | 21.5 × 50 | 25.0 | 110 | — |

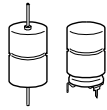

Soldering star capacitors

Dimensional drawing

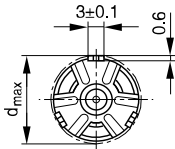

Mounting holes
d = 12 mm ... 14 mm

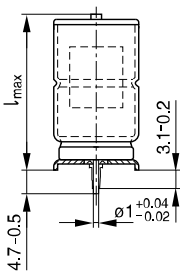
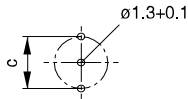

Mounting holes
d = 16 mm ... 18 mm

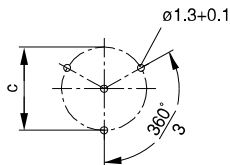

KAL0666-9

Dimensions, weights and packing units

| d × l mm | d _{max} × l _{max} mm | c ±0.1 mm | Approx. weight g | Packing units pcs. |
|-------------|---|--------------|---------------------|-----------------------|
| 12 × 30 | 13.5 × 32 | 12.5 | 5.4 | 480 |
| 14 × 25 | 15.5 × 27 | 14.5 | 6.1 | 480 |
| 14 × 30 | 15.5 × 32 | 14.5 | 7.2 | 480 |
| 16 × 30 | 17.5 × 32 | 16.5 | 9.4 | 300 |
| 16 × 39 | 17.5 × 41.5 | 16.5 | 12.2 | 200 |
| 18 × 30 | 19.5 × 32 | 18.5 | 11.8 | 300 |
| 18 × 39 | 19.5 × 41.5 | 18.5 | 15.4 | 200 |

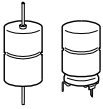

B41694, B41794

Low ESR – up to 140 °C

Overview of available types

| V_R (V DC) | 25 | 40 |
|-------------------------|-----------------------------------|---------|
| | Case dimensions $d \times l$ (mm) | |
| C_R (μF) | | |
| 330 | | 12 × 30 |
| 470 | 14 × 25 | 14 × 30 |
| 680 | | 16 × 30 |
| 1000 | 16 × 30 | 18 × 30 |
| 1200 | | 20 × 29 |
| 1500 | 16 × 39 18 × 30 | 18 × 39 |
| 1800 | 20 × 29 | |
| 2200 | 18 × 39 | 21 × 39 |
| 2700 | | 21 × 49 |
| 3300 | 21 × 39 | |
| 3900 | 21 × 49 | |

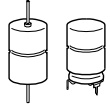
Case dimensions and ordering codes

| V_R | C_R | Case dimensions $d \times l$ mm | Ordering code Axial pallet | Ordering code Axial reel | Ordering code Soldering star |
|-------|---------|---------------------------------------|-------------------------------|-----------------------------|---------------------------------|
| V DC | μF | | | | |
| 25 | 470 | 14 × 25 | B41694A5477Q007 | B41694A5477Q009 | B41794A5477Q000 |
| | 1000 | 16 × 30 | B41694A5108Q007 | B41694A5108Q009 | B41794A5108Q000 |
| | 1500 | 16 × 39 | B41694A5158Q007 | | B41794A5158Q000 |
| | 1500 ▽ | 18 × 30 | B41694C5158Q007 | | B41794C5158Q000 |
| | 1800 | 20 × 29 | B41694A5188Q007 | | |
| | 2200 | 18 × 39 | B41694A5228Q007 | | B41794A5228Q000 |
| | 3300 | 21 × 39 | B41694A5338Q007 | | |
| | 3900 | 21 × 49 | B41694A5398Q007 | | |
| 40 | 330 | 12 × 30 | B41694A7337Q007 | B41694A7337Q009 | B41794A7337Q000 |
| | 470 | 14 × 30 | B41694B7477Q007 | B41694B7477Q009 | B41794B7477Q000 |
| | 680 | 16 × 30 | B41694A7687Q007 | B41694A7687Q009 | B41794A7687Q000 |
| | 1000 | 18 × 30 | B41694B7108Q007 | | B41794B7108Q000 |
| | 1200 | 20 × 29 | B41694A7128Q007 | | |
| | 1500 | 18 × 39 | B41694B7158Q007 | | B41794B7158Q000 |
| | 2200 | 21 × 39 | B41694A7228Q007 | | |
| | 2700 | 21 × 49 | B41694A7278Q007 | | |

▽ Variant with different case dimensions

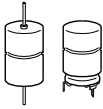

B41694, B41794

Low ESR – up to 140 °C

Technical data

| C_R | ESR _{typ} | ESR _{max} | ESR _{max} | ESR _{max} | Z _{max} | I _{AC,max} | I _{AC,max} | I _{AC,max} | I _{AC,R} | I _{AC,max} |
|--------------------------------|--------------------|--------------------|--------------------|--------------------|------------------|---------------------|---------------------|---------------------|-------------------|---------------------|
| 100 Hz | 100 Hz | 100 Hz | 100 Hz | 10 kHz | 100 kHz | 10 kHz | 10 kHz | 10 kHz | 10 kHz | 10 kHz |
| 20 °C | 20 °C | 20 °C | -40 °C | 20 °C | 20 °C | 85 °C | 105 °C | 125 °C | 125 °C | 140 °C |
| μF | mΩ | mΩ | mΩ | mΩ | mΩ | A | A | A | A | A |
| V_R = 25 V DC | | | | | | | | | | |
| 470 | 100 | 160 | 400 | 65 | 60 | 5.3 | 4.6 | 3.6 | 2.35 | 2.35 |
| 1000 | 50 | 80 | 200 | 38 | 35 | 7.3 | 6.3 | 4.9 | 3.2 | 3.2 |
| 1500 | 35 | 55 | 150 | 26 | 24 | 10.0 | 8.7 | 6.8 | 4.4 | 4.4 |
| 1500 ▽ | 32 | 51 | 150 | 22 | 20 | 10.7 | 9.3 | 7.3 | 4.7 | 4.7 |
| 1800 | 27 | 44 | 130 | 19 | 19 | 11.3 | 9.9 | 7.7 | 5.0 | 5.0 |
| 2200 | 22 | 35 | 110 | 15 | 14 | 14.6 | 12.7 | 9.9 | 6.4 | 6.4 |
| 3300 | 17 | 27 | 80 | 13 | 13 | 15.7 | 13.6 | 10.7 | 6.9 | 6.9 |
| 3900 | 14 | 22 | 60 | 10 | 10 | 19.8 | 17.2 | 13.5 | 8.7 | 8.7 |
| V_R = 40 V DC | | | | | | | | | | |
| 330 | 120 | 200 | 450 | 65 | 60 | 5.7 | 4.9 | 3.9 | 2.5 | 2.5 |
| 470 | 85 | 140 | 350 | 47 | 44 | 6.6 | 5.8 | 4.5 | 2.9 | 2.9 |
| 680 | 60 | 100 | 250 | 38 | 36 | 7.3 | 6.3 | 5.0 | 3.2 | 3.2 |
| 1000 | 40 | 65 | 180 | 23 | 22 | 10.6 | 9.2 | 7.2 | 4.6 | 4.6 |
| 1200 | 35 | 57 | 140 | 21 | 20 | 11.4 | 9.8 | 7.7 | 5.0 | 5.0 |
| 1500 | 27 | 45 | 120 | 16 | 15 | 14.5 | 12.6 | 9.9 | 6.3 | 6.3 |
| 2200 | 21 | 33 | 85 | 13 | 13 | 15.8 | 13.8 | 10.8 | 6.9 | 6.9 |
| 2700 | 17 | 27 | 65 | 11 | 11 | 19.9 | 17.3 | 13.5 | 8.7 | 8.7 |

▽ Variant with different case dimensions

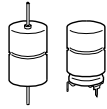

Useful life

depending on ambient temperature T_A under ripple current operating conditions at $V_R^{1)}$

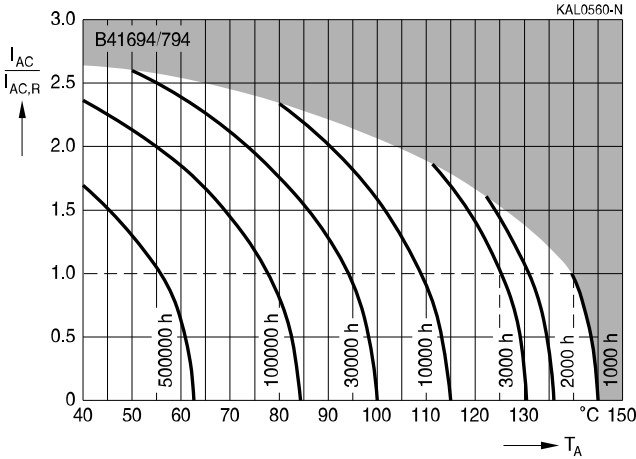

Useful life

depending on case temperature T_C under ripple current operating conditions at $V_R^{1)}$

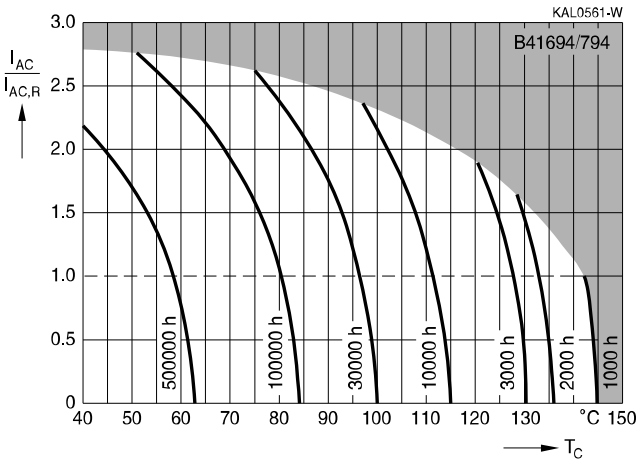

1) Refer to chapter "General technical information, 5.3 Calculation of useful life" for an explanation on how to interpret the useful life graphs.

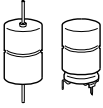

B41694, B41794

Low ESR – up to 140 °C

Frequency factor of permissible ripple current I_{AC} versus frequency f

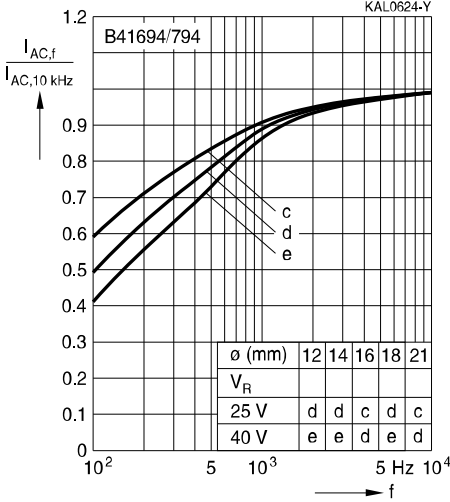

Frequency characteristics of ESR

Typical behavior

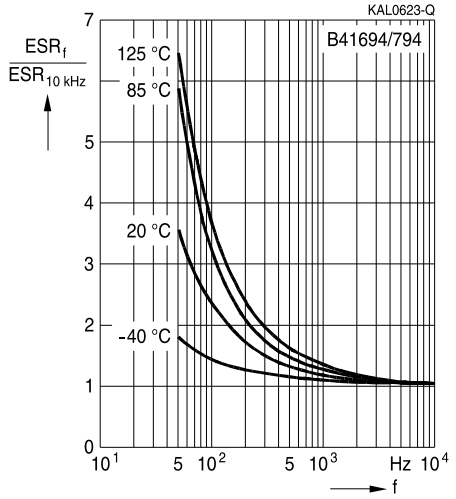

Equivalent series resistance ESR versus frequency f

Typical behavior for 1000 μ F/40 V

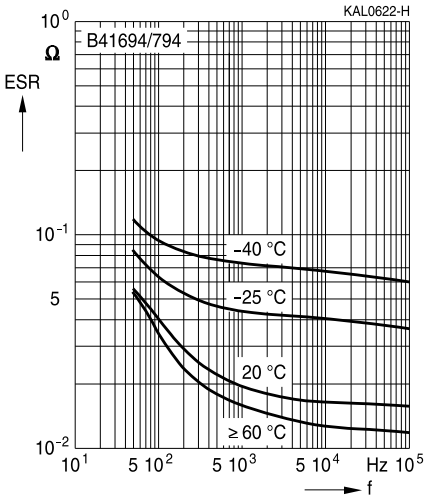

Impedance Z versus frequency f

Typical behavior for 1000 μ F/40 V

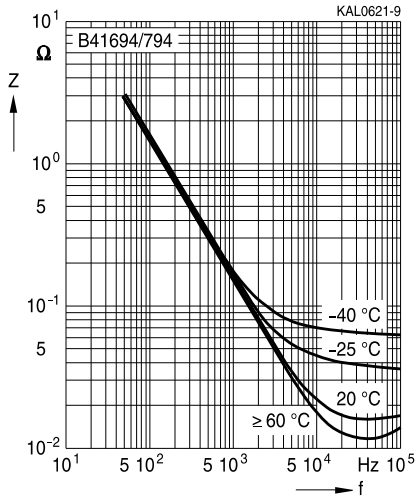

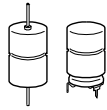

Cautions and warnings

Personal safety

The electrolytes used by EPCOS have not only been optimized with a view to the intended application, but also with regard to health and environmental compatibility. They do not contain any solvents that are detrimental to health, e.g. dimethyl formamide (DMF) or dimethyl acetamide (DMAC).

Furthermore, part of the high-voltage electrolytes used by EPCOS are self-extinguishing. They contain flame-retarding substances which will quickly extinguish any flame that may have been ignited.

As far as possible, EPCOS does not use any dangerous chemicals or compounds to produce operating electrolytes. However, in exceptional cases, such materials must be used in order to achieve specific physical and electrical properties because no safe substitute materials are currently known. However, the amount of dangerous materials used in our products has been limited to an absolute minimum. Nevertheless, the following rules should be observed when handling Al electrolytic capacitors:

- Any escaping electrolyte should not come into contact with eyes or skin.
- If electrolyte does come into contact with the skin, wash the affected parts immediately with running water. If the eyes are affected, rinse them for 10 minutes with plenty of water. If symptoms persist, seek medical treatment.
- Avoid breathing in electrolyte vapor or mists. Workplaces and other affected areas should be well ventilated. Clothing that has been contaminated by electrolyte must be changed and rinsed in water.

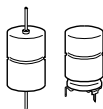
B41694, B41794
Low ESR – up to 140 °C

Product safety

The table below summarize the safety instructions that must be observed without fail. A detailed description can be found in the relevant sections of chapter "General technical information".

| Topic | Safety information | Reference Chapter "General technical information" |
|--|---|---|
| Polarity | Make sure that polar capacitors are connected with the right polarity. | 1 "Basic construction of aluminum electrolytic capacitors" |
| Reverse voltage | Voltages polarity classes should be prevented by connecting a diode. | 3.1.6 "Reverse voltage" |
| Upper category temperature | Do not exceed the upper category temperatur. | 7.2 "Maximum permissible operating temperature" |
| Maintenance | Make periodic inspections of the capacitors. Before the inspection, make sure that the power supply is turned off and carefully discharge the electricity of the capacitors. Do not apply any mechanical stress to the capacitor terminals. | 10 "Maintenance" |
| Mounting position of screw terminal capacitors | Do not mount the capacitor with the terminals (safety vent) upside down. | 11.1 "Mounting positions of capacitors with screw terminals" |
| Mounting of single-ended capacitors | The internal structure of single-ended capacitors might be damaged if excessive force is applied to the lead wires. Avoid any compressive, tensile or flexural stress. Do not move the capacitor after soldering to PC board. Do not pick up the PC board by the soldered capacitor. Do not insert the capacitor on the PC board with a hole space different to the lead space specified. | 11.4 "Mounting considerations for single-ended capacitors" |
| Robustness of terminals | The following maximum tightening torques must not be exceeded when connecting screw terminals: M5: 2 Nm M6: 2.5 Nm | 11.3 "Mounting torques" |
| Soldering | Do not exceed the specified time or temperature limits during soldering. | 11.5 "Soldering" |

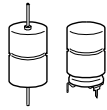

| Topic | Safety information | Reference Chapter "General technical information" |
|--|---|---|
| Soldering, cleaning agents | Do not allow halogenated hydrocarbons to come into contact with aluminum electrolytic capacitors. | 11.6 "Cleaning agents" |
| Passive flammability | Avoid external energy, such as fire or electricity. | 8.1 "Passive flammability" |
| Active flammability | Avoid overload of the capacitors. | 8.2 "Active flammability" |
| | | Reference Chapter "Capacitors with screw terminals" |
| Breakdown strength of insulating sleeves | Do not damage the insulating sleeve, especially when ring clips are used for mounting. | "Screw terminals - accessories" |

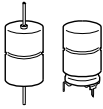
B41694, B41794
Low ESR – up to 140 °C
Symbols and terms

| Symbol | English | German |
|----------------|---|---|
| C | Capacitance | Kapazität |
| C_R | Rated capacitance | Nennkapazität |
| C_S | Series capacitance | Serienkapazität |
| $C_{S,T}$ | Series capacitance at temperature T | Serienkapazität bei Temperatur T |
| C_f | Capacitance at frequency f | Kapazität bei Frequenz f |
| d | Case diameter, nominal dimension | Gehäusedurchmesser, Nennmaß |
| d_{max} | Maximum case diameter | Maximaler Gehäusedurchmesser |
| ESL | Self-inductance | Eigeninduktivität |
| ESR | Equivalent series resistance | Ersatzserienwiderstand |
| ESR_f | Equivalent series resistance at frequency f | Ersatzserienwiderstand bei Frequenz f |
| ESR_T | Equivalent series resistance at temperature T | Ersatzserienwiderstand bei Temperatur T |
| f | Frequency | Frequenz |
| I | Current | Strom |
| I_{AC} | Alternating current (ripple current) | Wechselstrom |
| $I_{AC,rms}$ | Root-mean-square value of alternating current | Wechselstrom, Effektivwert |
| $I_{AC,f}$ | Ripple current at frequency f | Wechselstrom bei Frequenz f |
| $I_{AC,max}$ | Maximum permissible ripple current | Maximal zulässiger Wechselstrom |
| $I_{AC,R}$ | Rated ripple current | Nennwechselstrom |
| $I_{AC,R} (B)$ | Rated ripple current for base cooling | Nennwechselstromstrom für Bodenkühlung |
| I_{leak} | Leakage current | Ableitstrom |
| $I_{leak,op}$ | Operating leakage current | Ableitstrom bei Betrieb |
| l | Case length, nominal dimension | Gehäuselänge, Nennmaß |
| l_{max} | Maximum case length (without terminals and mounting stud) | Maximale Gehäuselänge (ohne Anschlüsse und Gewindebolzen) |
| R | Resistance | Widerstand |
| R_{ins} | Insulation resistance | Isolationswiderstand |
| R_{symm} | Balancing resistance | Symmetrierwiderstand |
| T | Temperature | Temperatur |
| ΔT | Temperature difference | Temperaturdifferenz |
| T_A | Ambient temperature | Umgebungstemperatur |
| T_C | Case temperature | Gehäusetemperatur |
| T_B | Capacitor base temperature | Temperatur des Becherbodens |
| t | Time | Zeit |
| Δt | Period | Zeitraum |
| t_b | Service life (operating hours) | Brauchbarkeitsdauer (Betriebszeit) |

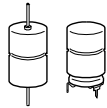

| Symbol | English | German |
|-----------------|-----------------------------|-----------------------------------|
| V | Voltage | Spannung |
| V _F | Forming voltage | Formierspannung |
| V _{op} | Operating voltage | Betriebsspannung |
| V _R | Rated voltage, DC voltage | Nennspannung, Gleichspannung |
| V _S | Surge voltage | Spitzenspannung |
| X _C | Capacitive reactance | Kapazitiver Blindwiderstand |
| X _L | Inductive reactance | Induktiver Blindwiderstand |
| Z | Impedance | Scheinwiderstand |
| Z _T | Impedance at temperature T | Scheinwiderstand bei Temperatur T |
| tan δ | Dissipation factor | Verlustfaktor |
| λ | Failure rate | Ausfallrate |
| ε ₀ | Absolute permittivity | Elektrische Feldkonstante |
| ε _r | Relative permittivity | Dielektrizitätszahl |
| ω | Angular velocity; 2 · π · f | Kreisfrequenz; 2 · π · f |

Notes

All dimensions are given in mm.

Important notes

The following applies to all products named in this publication:

1. Some parts of this publication contain **statements about the suitability of our products for certain areas of application**. These statements are based on our knowledge of typical requirements that are often placed on our products in the areas of application concerned. We nevertheless expressly point out **that such statements cannot be regarded as binding statements about the suitability of our products for a particular customer application**. As a rule, EPCOS is either unfamiliar with individual customer applications or less familiar with them than the customers themselves. For these reasons, it is always ultimately incumbent on the customer to check and decide whether an EPCOS product with the properties described in the product specification is suitable for use in a particular customer application.
2. We also point out that **in individual cases, a malfunction of electronic components or failure before the end of their usual service life cannot be completely ruled out in the current state of the art, even if they are operated as specified**. In customer applications requiring a very high level of operational safety and especially in customer applications in which the malfunction or failure of an electronic component could endanger human life or health (e.g. in accident prevention or lifesaving systems), it must therefore be ensured by means of suitable design of the customer application or other action taken by the customer (e.g. installation of protective circuitry or redundancy) that no injury or damage is sustained by third parties in the event of malfunction or failure of an electronic component.
3. **The warnings, cautions and product-specific notes must be observed.**
4. In order to satisfy certain technical requirements, **some of the products described in this publication may contain substances subject to restrictions in certain jurisdictions (e.g. because they are classed as hazardous)**. Useful information on this will be found in our Material Data Sheets on the Internet (www.epcos.com/material). Should you have any more detailed questions, please contact our sales offices.
5. We constantly strive to improve our products. Consequently, **the products described in this publication may change from time to time**. The same is true of the corresponding product specifications. Please check therefore to what extent product descriptions and specifications contained in this publication are still applicable before or when you place an order. We also **reserve the right to discontinue production and delivery of products**. Consequently, we cannot guarantee that all products named in this publication will always be available. The aforementioned does not apply in the case of individual agreements deviating from the foregoing for customer-specific products.
6. Unless otherwise agreed in individual contracts, **all orders are subject to the current version of the "General Terms of Delivery for Products and Services in the Electrical Industry" published by the German Electrical and Electronics Industry Association (ZVEI)**.
7. The trade names EPCOS, BAOKE, Alu-X, CeraDiode, CSSP, CTVS, DSSP, MiniBlue, MKK, MLSC, MotorCap, PCC, PhaseCap, PhaseMod, SIFERRIT, SIFI, SIKOREL, SilverCap, SIMDAD, SIMID, SineFormer, SIOV, SIP5D, SIP5K, ThermoFuse, WindCap are **trademarks registered or pending** in Europe and in other countries. Further information will be found on the Internet at www.epcos.com/trademarks.