

### VPT36-4440

#### Electrical Specifications (@25C)

1. Maximum Power: 160VA
2. Input Voltage: **Series:** 230VAC, 50/60Hz  
**Parallel:** 115VAC, 50/60Hz
3. Output Voltage: **Series:** 36VAC CT @ 4.44A  
**Parallel:** 18.0VAC @ 8.88A
4. Voltage Regulation: 8% TYP from full load to no load
5. Temperature Rise: 50°C TYP
6. Hipot: 4000VAC, Primary to Secondary
7. Efficiency: 89% TYP. @ full load

#### Construction:

The toroidal construction inherently helps reduce stray fields, increases efficiency and minimizes size compared to traditional EI transformers. Built with Class B (130°) insulation system.

#### Safety:

World Series Transformers are designed and manufactured to meet most International Safety agency standards.

#### Agency File:

UL: File E122529, UL 506  
CE: EN 61558-1:2005, EN 61558-2-6:1995, Low Voltage Directive (LVD)  
EN 6-000-6-6:2001+A11:2004, EN 55014-1:2000+A1:2001+A2:2002, EN  
6100-6-1:2001, EN 55014-2:1997+A1:2001, Electromagnetic Compatibility (EMC)



#### Dimensions (mm):

H	I.D.	O.D.
48.0	32.0	103.0

Weight: 1.6Kg

#### Mounting:

Transformer is provided with one metal mounting plate, two rubber pads, M6 x 60mm bolt, nut, spring and flat washer.

#### Connections:

Transformer is provided with 8" (200mm) long, 0.25" (6mm) stripped and tinned, stranded UL 1015 lead wire.

**Input<sup>1</sup>:** Series – BLUE and BROWN, Jumper GRAY to VIOLET  
Parallel – BLUE and BROWN, Jumper BLUE to VIOLET, GRAY to BROWN

**Output<sup>1</sup>:** Series – BLACK and YELLOW, Jumper RED to ORANGE  
Parallel – BLACK and YELLOW, Jumper BLACK to ORANGE, RED to YELLOW

**RoHS Compliance:** Product meets the requirements of 2002/95/EC, known as the RoHS initiative.

\* Upon printing, this document is considered "uncontrolled". Please contact Triad Magnetics' website for the most current version.

<sup>1</sup> Primary and secondary windings are designed to be connected in series or parallel. Windings are not intended to be used independently.

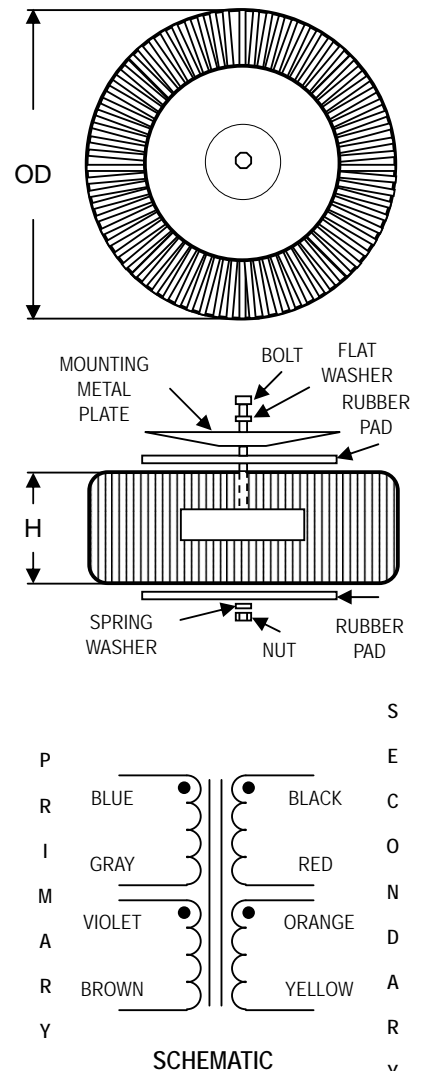

Web: [www.TriadMagnetics.com](http://www.TriadMagnetics.com)  
Phone 951-277-0757  
Fax 951-277-2757

22520B Temescal Canyon Road  
Corona, California  
92883

Release Date: June 12, 2009