

VPT48-10400

Electrical Specifications (@25C)

1. Maximum Power: 500VA
2. Input Voltage: **Series:** 230VAC, 50/60Hz
Parallel: 115VAC, 50/60Hz
3. Output Voltage: **Series:** 48VAC CT @ 10.4A
Parallel: 24.0VAC @ 20.8A
4. Voltage Regulation: 5% TYP from full load to no load
5. Temperature Rise: 50°C TYP
6. Hipot: 4000VAC, Primary to Secondary
7. Efficiency: 94% TYP. @ full load

Construction:

The toroidal construction inherently helps reduce stray fields, increases efficiency and minimizes size compared to traditional EI transformers. Built with Class B (130°) insulation system.

Safety:

World Series Transformers are designed and manufactured to meet most International Safety agency standards.

Agency File:

UL: File E122529, UL 506
CE: EN 61558-1:2005, EN 61558-2-6:1995, Low Voltage Directive (LVD)
EN 6-000-6-6:2001+A11:2004, EN 55014-1:2000+A1:2001+A2:2002, EN
6100-6-1:2001, EN 55014-2:1997+A1:2001, Electromagnetic Compatibility (EMC)



Dimensions (mm):

H	I.D.	O.D.
60.0	46.0	140.0

Weight: 4.2Kg

Mounting:

Transformer is provided with one metal mounting plate, two rubber pads, M8 x 70mm bolt, nut, spring and flat washer.

Connections:

Transformer is provided with 12" (305mm) long, 0.50" (12.7mm) stripped and tinned, stranded UL 1015 lead wire.

Input¹: Series – BLUE and BROWN, Jumper GRAY to VIOLET
Parallel – BLUE and BROWN, Jumper BLUE to VIOLET, GRAY to BROWN

Output¹: Series – BLACK and YELLOW, Jumper RED to ORANGE
Parallel – BLACK and YELLOW, Jumper BLACK to ORANGE, RED to YELLOW

RoHS Compliance: Product meets the requirements of 2002/95/EC, known as the RoHS initiative.

* Upon printing, this document is considered "uncontrolled". Please contact Triad Magnetics' website for the most current version.

¹ Primary and secondary windings are designed to be connected in series or parallel. Windings are not intended to be used independently.

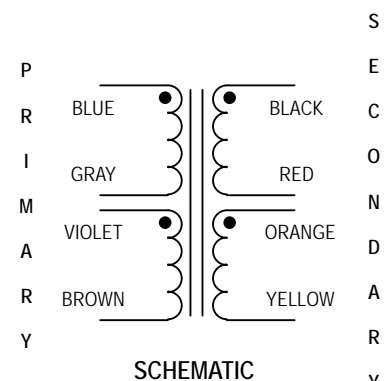
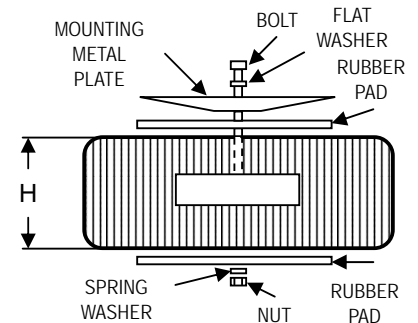
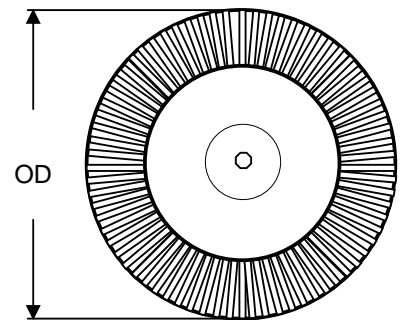

Web: www.TriadMagnetics.com
Phone 951-277-0757
Fax 951-277-2757

22520B Temescal Canyon Road
Corona, California
92883

Release Date: June 12, 2009