



LOW PROFILE, THREE FLANGE 2.5VA POWER TRANSFORMER APPROVED TO UL506 AND CSA C22.2 NO. 66-1988 AND USES A UL CLASS B (130°C) APPROVED INSULATION SYSTEM

REV. Status

REVISION -
09/23/99/ TS

REVISION A
ADDED RoHS
05/10/06 MP

REVISION B
ADDED THRU HOLE
DIMS. CLARIFIED
SCHEMATIC
05/01/07 MP

A. Electrical Specifications (@25°C)

1. Maximum Power: 2.5VA
2. Primary Voltage and Frequency: 115/230VAC 50/60Hz.
3. Secondary RMS Rating: See Table A on sheet 2
4. voltage Regulation: 35% TYP @ full load to no load
5. Temperature Rise: 25°C TYP (40°C MAX)
6. Insulation Resistance:
100MΩ MIN @ 500VDC, Pri to Sec, Pri to Core
100MΩ MIN @ 500VDC, Sec to core
7. Dielectric Withstand:
1500Vrms 1 minute @ Pri to Sec, Pri to Core
1500Vrms 1 minute @ Sec to Core



MODEL NUMBER

3FL & PF 2.5VA

- B. Marking: TAMURA, Tamura part number (see sheet 2)
MICROTRAN, Microtran part number (see sheet 2)
date code, country of origin, safety logos
and input and output ratings (see sheet 2)

C. Safety:

UL approved, UL506 File E145619, E79781
Insulation Class B (130°C) File No E92957
CSA Certified, C22.2 No. 66 File 081383
(3FL Series)

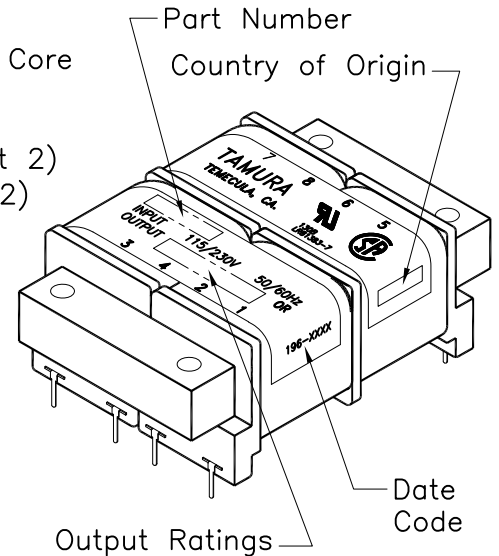

D. Mechanical Specifications:

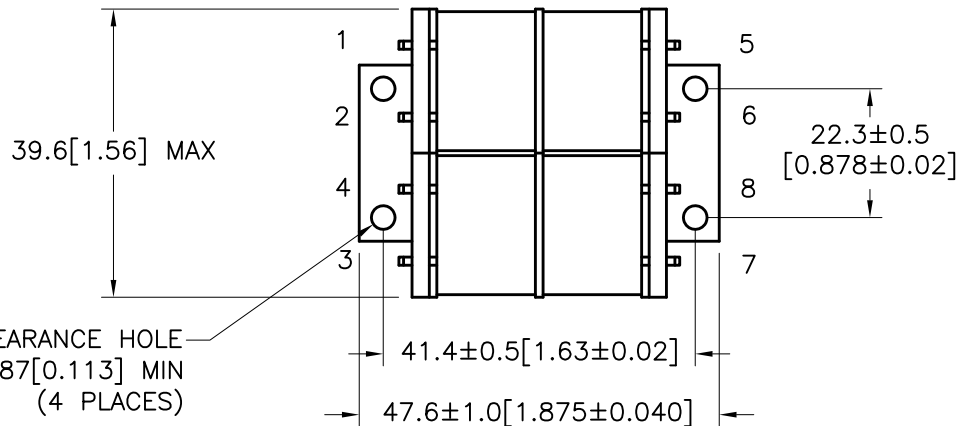
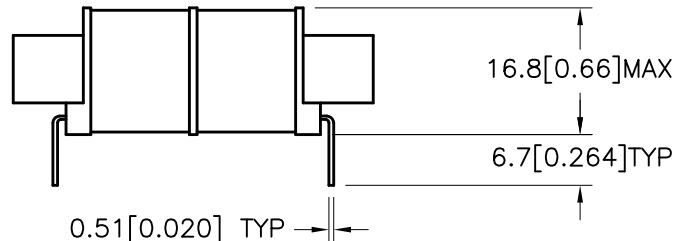
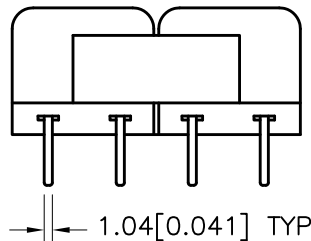

TOLERANCES (mm)	
≤ 4	± 0.2
4 ≤ 20	± 0.3
20 ≤ 50	± 0.4

PREPARED BY:

K. BRENNAN

ENGINEER:

M. PITCHAI

SAFETY ENGINEER

T. CLEM

APPROVED:

Y. SEKIGUCHI

DWG CONTROL NO.
P-A1-10568
ACAD\3F\A1105681.DWG

REV
B

2.5VA 3FL & PF SERIES
POWER TRANSFORMER

CONTENTS OF THIS DRAWING ARE
SUBJECT TO CHANGE WITHOUT
PRIOR NOTICE

TAMURA CORPORATION OF AMERICA
43352 BUSINESS PARK DRIVE, TEMECULA, CA. 92590-6624
(951) 699-1270 FAX 9516769482

3FL & PF 2.5VA

MODEL SPECIFICATION

DIM: mm [In] SCL: 1/1 SH: 1 OF 2

PROPRIETARY NOTICE: THIS DRAWING PRINT OR DOCUMENT AND SUBJECT MATTER DISCLOSED HEREIN ARE PROPRIETARY ITEMS TO WHICH TAMURA RETAINS THE EXCLUSIVE RIGHT OF DISSEMINATION, REPRODUCTION, MANUFACTURE AND SALE. THIS DRAWING, PRINT OR DOCUMENT IS SUBMITTED IN CONFIDENCE FOR CONSIDERATION BY THE RECIPIENT ALONE UNLESS PERMISSION FOR FURTHER DISCLOSURE IS EXPRESSLY GRANTED IN WRITING.

E. Mounting Footprint:

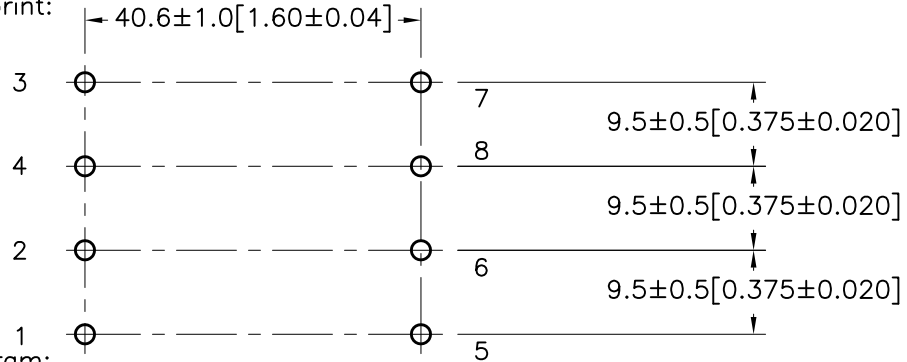

F. Schematic Diagram:

PRIMARY INPUT CONNECTIONS

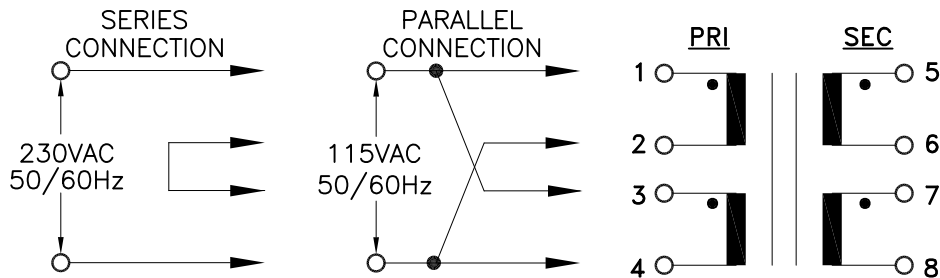

SECONDARY OUTPUT CONNECTIONS

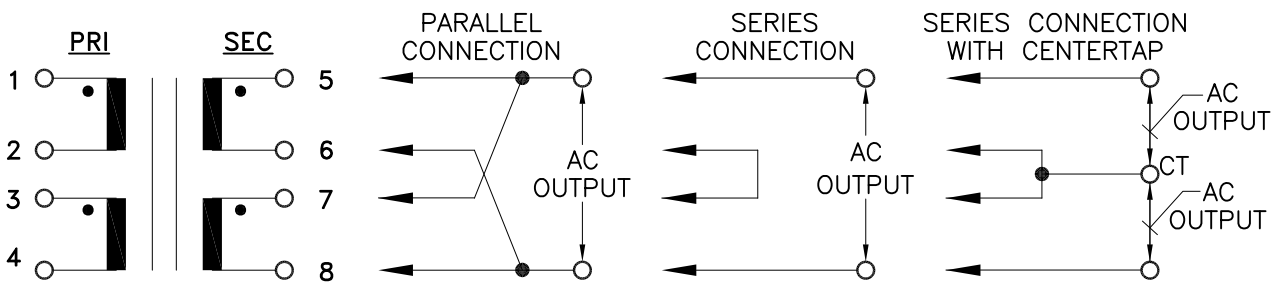

G. Table A:

TAMURA PART NO.	MICROTRAN PART NO.	PARALLEL CONNECTION		SERIES CONNECTION		SERIES CONNECTION WITH CT	
		AC VOLTS	RMS AMPS	AC VOLTS	RMS AMPS	AC VOLTS	RMS AMPS
3FL10-250	PF2.5-10	5.0	0.500	10.0	0.250	5.0-CT-5.0	0.250
3FL12-200	PF2.5-12	6.3	0.400	12.6	0.200	6.3-CT-6.3	0.200
3FL16-150	PF2.5-16	8.0	0.300	16.0	0.150	8.0-CT-8.0	0.150
3FL20-125	PF2.5-20	10.0	0.250	20.0	0.125	10.0-CT-10.0	0.125
3FL24-100	PF2.5-24	12.0	0.200	24.0	0.100	12.0-CT-12.0	0.100
3FL30-85	PF2.5-30	15.0	0.170	30.0	0.085	15.0-CT-15.0	0.085
3FL34-75	PF2.5-34	17.0	0.150	34.0	0.075	17.0-CT-17.0	0.075
3FL40-60	N/A	20.0	0.120	40.0	0.060	20.0-CT-20.0	0.060
3FL56-45	PF2.5-56	28.0	0.090	56.0	0.045	28.0-CT-28.0	0.045
3FL88-28	N/A	44.0	0.056	88.0	0.028	44.0-CT-44.0	0.028
3FL120-20	N/A	60.0	0.040	120.0	0.020	60.0-CT-60.0	0.020
3FL230-10	N/A	115.0	0.020	230.0	0.010	115.0-CT-115.0	0.010

PREPARED BY:

K. BRENNAN

ENGINEER:

M. PITCHAI

SAFETY ENGINEER:

T. CLEM

APPROVED:

Y. SEKIGUCHI

DWG CONTROL NO. P-A1-10568
ACAD\3F\A1105681.DWG
REV B

2.5VA 3FL & PF SERIES
POWER TRANSFORMER

TAMURA CORPORATION OF AMERICA
43352 BUSINESS PARK DRIVE, TEMECULA, CA. 92590-6624
(951) 699-1270 FAX 9516769482

3FL & PF 2.5VA

MODEL SPECIFICATION

DIM: mm[In] SCL: 1/1 SH: 2 OF 2

PROPRIETARY NOTICE: THIS DRAWING PRINT OR DOCUMENT AND SUBJECT MATTER DISCLOSED HEREIN ARE PROPRIETARY ITEMS TO WHICH TAMURA RETAINS THE EXCLUSIVE RIGHT OF DISSEMINATION, REPRODUCTION, MANUFACTURE AND SALE. THIS DRAWING, PRINT OR DOCUMENT IS SUBMITTED IN CONFIDENCE FOR CONSIDERATION BY THE RECIPIENT ALONE UNLESS PERMISSION FOR FURTHER DISCLOSURE IS EXPRESSLY GRANTED IN WRITING.

MODEL NUMBER
3FL & PF 2.5VA