

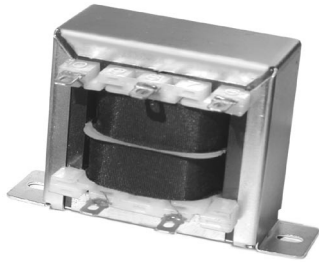









# LAMINATED TRANSFORMERS

## Low Frequency, Open-Style Laminated, Chassis-Tran Series



**AGENCY APPROVALS** 

- UL, 506, File E73539
- UL 1446, File E179499
- CSA 22.2#66, File LR68051-2 
- UL Recognized Class B

-  Channel frame mounting
-  Split bobbin. High isolation (2500V). 2500VRMS Hipot
-  Non-concentric design - eliminates ESS
-  No crossover between primary/secondary winding leads
-  Vacuum impregnated - withstands board washing systems and reduces audible noise
-  Baked resin provides environmentally-resistant finish
-  Center tapped secondary offers dual outputs
-  Terminals suitable for either hard wiring or quick connect

Part Number		Secondary RMS Rating
Single 115V	Dual 115/230V	
241-3-10A1	(not available)	10V C.T. @ 0.25A
241-4-10A11	DP 241-4-10A11	10V C.T. @ 0.6A
241-5-10A21	DP 241-5-10A21	10V C.T. @ 1.2A
241-6-10A31	DP 241-6-10A31	10V C.T. @ 3.0A
241-7-10A41	DP 241-7-10A41	10V C.T. @ 5.0A
241-8-10A51	DP 241-8-10A51	10V C.T. @ 10A
241-3-12A2	(not available)	12.6V C.T. @ 0.2A
241-4-12A12	DP 241-4-12A12	12.6V C.T. @ 0.5A
241-5-12A22	DP 241-5-12A22	12.6V C.T. @ 1.0A
241-6-12A32	DP 241-6-12A32	12.6V C.T. @ 2.5A
241-7-12A42	DP 241-7-12A42	12.6V C.T. @ 4.0A
241-8-12A52	DP 241-8-12A52	12.6V C.T. @ 8.0A
241-3-16A3	(not available)	16V C.T. @ 0.15A
241-4-16A13	DP 241-4-16A13	16V C.T. @ 0.4A
241-5-16A23	DP 241-5-16A23	16V C.T. @ 0.8A
241-6-16A33	DP 241-6-16A33	16V C.T. @ 2.0A
241-7-16A43	DP 241-7-16A43	16V C.T. @ 3.5A
241-8-16A53	DP 241-8-16A53	16V C.T. @ 6.25A
241-3-20A4	(not available)	20V C.T. @ 0.12A
241-4-20A14	DP 241-4-20A14	20V C.T. @ 0.3A
241-5-20A24	DP 241-5-20A24	20V C.T. @ 0.6A
241-6-20A34	DP 241-6-20A34	20V C.T. @ 1.5A
241-7-20A44	DP 241-7-20A44	20V C.T. @ 2.8A
241-8-20A54	DP 241-8-20A54	20V C.T. @ 5.0A
241-3-24A5	(not available)	24V C.T. @ 0.1A
241-4-24A15	DP 241-4-24A15	24V C.T. @ 0.25A
241-5-24A25	DP 241-5-24A25	24V C.T. @ 0.5A
241-6-24A35	DP 241-6-24A35	24V C.T. @ 1.25A
241-7-24A45	DP 241-7-24A45	24V C.T. @ 2.4A
241-8-24A55	DP 241-8-24A55	24V C.T. @ 4.0A
241-3-28A6	(not available)	28V C.T. @ 0.085A
241-4-28A16	DP 241-4-28A16	28V C.T. @ 0.2A
241-5-28A26	DP 241-5-28A26	28V C.T. @ 0.42A
241-6-28A36	DP 241-6-28A36	28V C.T. @ 1.1A
241-7-28A46	DP 241-7-28A46	28V C.T. @ 2.0A
241-8-28A56	DP 241-8-28A56	28V C.T. @ 3.6A
241-3-36A7	(not available)	36V C.T. @ 0.065A
241-4-36A17	DP 241-4-36A17	36V C.T. @ 0.17A
241-5-36A27	DP 241-5-36A27	36V C.T. @ 0.35A
241-6-36A37	DP 241-6-36A37	36V C.T. @ 0.85A
241-7-36A47	DP 241-7-36A47	36V C.T. @ 1.5A
241-8-36A57	DP 241-8-36A57	36V C.T. @ 2.8A
241-3-48A8	(not available)	48V C.T. @ 0.05A
241-4-48A18	DP 241-4-48A18	48V C.T. @ 0.125A
241-5-48A28	DP 241-5-48A28	48V C.T. @ 0.25A
241-6-48A38	DP 241-6-48A38	48V C.T. @ 0.63A
241-7-48A48	DP 241-7-48A48	48V C.T. @ 1.2A
241-8-48A58	DP 241-8-48A58	48V C.T. @ 2.0A
241-3-56A9	(not available)	56V C.T. @ 0.045A
241-4-56A19	DP 241-4-56A19	56V C.T. @ 0.11A
241-5-56A29	DP 241-5-56A29	56V C.T. @ 0.22A
241-6-56A39	DP 241-6-56A39	56V C.T. @ 0.54A
241-7-56A49	DP 241-7-56A49	56V C.T. @ 1.0A
241-8-56A59	DP 241-8-56A59	56V C.T. @ 1.8A
241-3-120A10	(not available)	120V C.T. @ 0.02A
241-4-120A20	DP 241-4-120A20	120V C.T. @ 0.05A
241-5-120A30	DP 241-5-120A30	120V C.T. @ 0.1A
241-6-120A40	DP 241-6-120A40	120V C.T. @ 0.25A
241-7-120A50	DP 241-7-120A50	120V C.T. @ 0.5A
241-8-120A60	DP 241-8-120A60	120V C.T. @ 0.85A

### Mechanicals

### Schematics

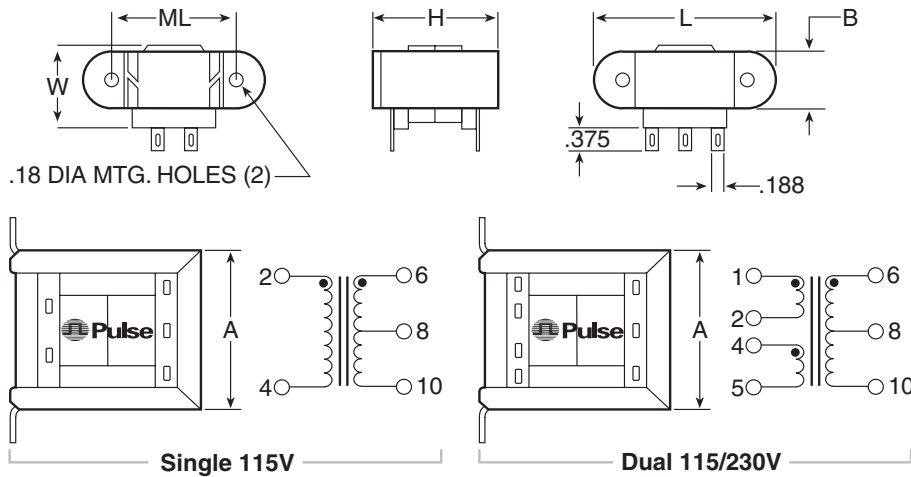

### Dimensions (inches)

Size	VA	L	W	H	A	B	ML	Wt. (lb.)
3	2.4	2.06	1.06	1.19	1.62	0.56	1.75	0.25
4	6	2.38	1.25	1.38	1.69	0.69	2.00	0.44
5	12	2.81	1.38	1.63	1.94	0.81	2.38	0.70
6	30	3.25	1.69	1.94	2.31	1.06	2.81	1.10
7	56	3.69	1.81	2.25	2.69	1.06	3.13	1.70
8	100	4.03	2.25	2.56	3.06	1.31	3.56	2.75