

5 0 Y E A R S O F E X C E L L E N C E

PANAVISE[®]
Innovative Holding Solutions[™]

PANAVISE[®]

The Industry Leader In:

> Work Holding Tools > CCTV Camera Mounts > Audio / Video Mounts > Mobile Electronics Mounts





Vision to Vise

PanaVise Products, Inc. was founded in 1956 by tool and die maker Otto Colbert.



PanaVise Products, Inc. designs, engineers and manufactures its "innovative holding solutions" in Reno, Nevada. Our 58,000 square foot facility contains our corporate offices, as well as manufacturing, warehousing and shipping facilities.

New product design is the responsibility of our engineering department. Special customer generated (OEM) projects are expertly guided through the engineering process, then carefully manufactured to meet your exact specifications. A wide range of equipment, including computerized lathes, sheet metal stamping machinery, bending, deburring, painting, and powder coating stations, means we can control the manufacturing process from beginning to end.

If you have a specific project in mind, don't hesitate to consult our engineering department at **1.800.759.7535**.

In 1956, Mr. Colbert needed an easy way to inspect and work on his dies. To make his work more productive, he invented and patented the famous "**split-ball**." The split-ball is a clever adaptation that allows a vise head to move easily through three planes (Tilt, Turn & Rotate) and to lock securely into position with a single control knob. To this day, his invention still forms the core of our product line.

Following in Mr. Colbert's footsteps, PanaVise continues to design and manufacture products that solve practical problems. Over the years, a natural outgrowth of our work holding expertise has been to develop other items which hold things securely and offer a wide range of motion. Our Mobile Electronics, CCTV Camera Mounts, and Audio/Video Mounts are perfect examples of how we've applied Mr. Colbert's philosophy to solve practical, real-world problems. Our dedication to finding innovative holding solutions has earned us the nickname "**the hold it anywhere you want it company.**"

PanaVise Products, Inc. is located in beautiful northern Nevada and operates in a 58,000 square foot facility (see photo, right). Our on-site engineering and manufacturing facilities give us complete control over product design, development, and production. We still believe in manufacturing quality products, and are dedicated to making the world's most "**Innovative Holding Solutions.**"

If you have questions about any of the products contained within this catalog, please call a PanaVise Representative at **1.800.759.7535**. Additional information can be found at our website, **www.panavise.com**.

Table of Contents

> Innovative Holding Solutions™

Limited Lifetime Warranty

All PanaVise products are warranted against defective materials and/or workmanship to all original consumer owners from the date of original consumer purchase for the lifetime of ownership by the original consumer owner. In the event of defective materials and/or workmanship, PanaVise Products, Inc. will, without charge, repair or replace, at its option, the defective product within 60-days from the receipt of the defective product at the following address:

PanaVise Products, Inc.
ATTN: Warranty Department
7540 Colbert Drive
Reno, NV 89511-1225

In order to make a claim under this Warranty and to obtain performance of any obligation under warranty, the consumer must call PanaVise's Warranty Department at 1.800.759.7535. Questions will be answered and/or instructions given on how to return the defective product to PanaVise.

The Warranty does not apply to damage not resulting from defective materials and/or workmanship while in the possession of the original consumer or to unreasonable use by the original consumer, which includes but is not limited to improper installation, or failure to provide reasonable and necessary maintenance. (Due to normal wear and tear, vise jaws, suction cups and vacuum pads are not covered by this Warranty.) PanaVise Products, Inc. is not liable for any incidental or consequential damages. Some states do not allow the exclusion or limitation of incidental or consequential damages, so the above limitation or exclusion may not apply to you. This Warranty gives you specific legal rights, and you may also have other rights which vary from state to state.

Patents, Trademarks & Copyright

PanaVise's products are protected under one or more of the following U.S. Patents: 2,898,068; 3,661,376; 5,118,058; 5,187,744; 5,465,932; D390,849. Patents pending on additional products in the U.S. and in other countries.

PanaVise, PanaPress, PV, PV Jr., Posi-Stop, Slimline, Slimline 2000, Uniflex, Stay-Put, PortaGrip, PortaGrip 2000, InDash, WindowGrip Deluxe, Multi Media Mount, ClipCaddy, and ViseBuddy are registered trademarks or trademarks of PanaVise Products, Inc. in the U.S. and in other countries.

All materials contained in this catalog (such as text, graphics, logos, pictures, and images) are protected by United States copyright law and may not be reproduced, distributed, transmitted, displayed, published, or broadcast without the prior written permission of PanaVise Products, Inc. You may not remove or alter any copyright, patent, trademark, or other notice from this material.

©2006 PanaVise Products, Inc.

Product specifications are subject to change without notice.

Work Holding Tools : Vise Combinations, Heads, Bases & Arbor Presses

Work Holding Tools Introduction	4-5
Precision Vise Combinations	6-8
Component Interchangeability Chart	9
Vise Heads	10-12
Vise Bases	13
Vise Base Mounts	14-15
Circuit Board Holders	16-17
Circuit Board Accessories	17
PanaPress Arbor Press	18
PanaPress Retrofit Kits and Accessories	18-19
IDC Assembly Press Accessories	20
Heavy Duty Vise	21
Vise Accessories	22-23

CCTV Camera Mounts : For Professional Installers

CCTV Camera Mounts Introduction	24-25
Small Camera Mounts	26-27
J-Box Mounts	28-29
Standard Camera Mounts	30-31
Specialty Camera Mounts	32-33
Custom Component System	34-35

Audio/Video Mounts : For Speakers & Flat Panel Displays

Audio/Video Mounts Introduction	36-37
Small Speaker Mounts (up to 20 lbs.)	38-39
Large Speaker Mounts (up to 40 lbs.)	40-41
Flat Screen Mounts	42-43

Mobile Electronics Mounts : For Satellite Radios, GPS, Etc

Mobile Electronics Mounts Introduction	44-45
Window Mounts	46-47
Custom Dash Mounts and Accessories	48-49
Mounting Accessories	50-51
Mobile Electronics Holders	51
Pedestal Mounts	52-53
Radio and Communications Mounts	54
Custom Communications Mounting System	55
Mobile Data Terminal Mounts	56-58
Flex Mounts	59

Product Index : Quick Reference Guide

Index by Model Number	60
Index by Product Name	61



PARAVISE®

Work Holding Tools

> Innovative Holding Solutions™

Tilt, Turn & Rotate

PanaVise's patented "split-ball" allows the vise head to move smoothly through 3-planes: Tilts 90°, Turns & Rotates 360° to position the vise head exactly where you want it.



Accessories

Unique vise accessories (pages 22-23) help keep you organized! Here the Wire Manager, Model 358, keeps the leads under control, and when combined with the Solder Station, Model 371, makes a neat, efficient work station.

Interchangeability

All 300 series Vise Heads (pages 10-12) fit all 300 series Vise Bases (page 13). Work on a circuit board in the morning and a model train in the afternoon! If you already own a PanaVise, you can easily expand its capabilities by adding another Vise Head.



Base Mounts

Because you work in different environments, PanaVise Base Mounts help you work more efficiently. Base Mounts (pages 14-15) include mounting screws and fit the PV Jr. Model 201, 300 and 305 Bases.

One Knob; 3-planes

A single knob controls the Vise Head. Loosen the knob and the Vise Head moves smoothly into position; tighten it and the Vise Head locks into place.

NEXT >>>

Precision Vise Combinations

PanaVise vises and work holding tools have hundreds of uses limited only by your imagination! Each vise allows the head to "Tilt, Turn & Rotate" and position your work anywhere you want it. Our precision vises make any project more productive — PanaVise: "Better than a third hand!"

PV Jr. Model 201

The AMAZING Mini-Vise: perfect for arts and crafts, model making, electronics and other small projects!



Model 201 Features:

- > The easy-to-use single knob controls head movement through 3-planes: 210° Tilt, 360° Turn & 360° Rotation
- > Fine/coarse adjusting knob controls jaw pressure for delicate work
- > Grooved jaws are excellent for holding small objects and are made of reinforced thermal composite plastic [continuous heat tolerance to 350°F (177°C), intermittent heat up to 450°F (204°C)]
- > Jaws are 2" (50.8mm) tall, 1" (25.4mm) wide, and open to 2.875" (73mm)
Neoprene jaw pads are available (page 22) for holding extremely delicate items
- > Base features 4.3125" (109.5mm) bolt circle countersunk for three 1/4" (6.3mm) flat-head screws (not included); compatible with all PanaVise Base Mounts (pages 14-15)
- > **Height:** 6.75" (173mm), **Weight:** 1.2 lbs. (0.6kg)

Vacuum Base PV Jr. Model 209

The most PORTABLE precision vise you'll ever own! Ideal for light-duty field repairs, electronics, hobbies and more!



Model 209 Features:

- > The easy-to-use single knob controls head movement through 3-planes: 210° Tilt, 360° Turn & 360° Rotation
- > Fine/coarse adjusting knob controls jaw pressure for delicate work
- > Grooved jaws are excellent for holding small objects and are made of reinforced thermal composite plastic [continuous heat tolerance to 350°F (177°C), intermittent heat up to 450°F (204°C)]
- > Jaws are 2" (50.8mm) tall, 1" (25.4mm) wide, and open to 2.875" (73mm)
- > Arm movement is 140°; positive indents control movement to prevent "flopping"; the control knob locks the arm firmly into place
- > Lever locks vacuum pad into place on any smooth, flat, non-porous surface; lift tab to release vise from surface
- > **Base Diameter:** 3.4" (86.4mm), **Height:** 7.5" (173mm), **Weight:** 0.8 lbs. (0.4kg)

All PanaVise 300 series Vises have interchangeable components (see chart page 9). You can easily add another Head (pages 10-12) or Base Mount (pages 14-15). All PanaVise work holding tools will make your work space more efficient and productive — and they'll provide a lifetime of service.

Standard PanaVise Model 301

The ORIGINAL work holding tool for hobbies, electronics, small home repairs and work bench environments!



Model 301 Features:

- > The easy-to-use single knob controls head movement through 3-planes: 90° Tilt, 360° Turn & 360° Rotation
- > Jaws are 2.5" (63.5mm) wide, 0.5" (12.6mm) tall and open to 2.25" (57.1mm)
- > Nylon jaws offer excellent electrical insulation and gentle holding power [continuous heat tolerance up to 200°F (93°C), intermittent heat to 300°F (149°C)]. Interchangeable jaws available (page 22)
- > Base accepts all 300 series Heads and any 5/8" (15.9mm) diameter shaft
- > Base features 4.3125" (109.5 mm) bolt circle countersunk for three 1/4" (6.3mm) flat-head screws (not included)
- > **Height:** 6.25" (171.4mm), **Weight:** 2.7 lbs. (1.2kg)

Vacuum Base PanaVise Model 381

The world's most PORTABLE work holding tool for hobbies, electronics and small home repairs!



Model 381 Features:

- > Our Vacuum Base PanaVise is widely used for portable applications. Simply flip the lever to activate the rubber base and attach the unit to any smooth, flat, non-porous surface
- > Single knob controls head movement through 3-planes: 90° Tilt, 360° Turn & 360° Rotation
- > Jaws are 2.5" (63.5mm) wide, 0.5" (12.6mm) tall and open to 2.25" (57.1mm)
- > Nylon jaws offer excellent electrical insulation and gentle holding power [continuous heat tolerance up to 200°F (93°C), intermittent heat to 300°F (149°C)]. Interchangeable jaws available (page 22)
- > Base accepts all 300 series Heads and any 5/8" (15.9mm) diameter shaft
- > Pad footprint measures 5.125" x 4.25" (130.2mm x 108mm)
- > **Height:** 6.125" (155.6mm), **Weight:** 2.8 lbs. (1.3kg)

Precision Vise Combinations

We've selected some of our more specialized Heads, Bases and even a Base Mount to create two unique Vise combinations. These specialty tools are ready for a lifetime of service, plus they're compatible with all 300 series interchangeable components (chart page 9), and include the patented "split-ball" which allows a Head to be positioned through 3-planes: 90° Tilt, 360° Turn & 360° Rotation.

Multi-Purpose Work Center Model 350

The MULTI-PURPOSE work holding tool for larger, heavier objects. It's perfect for home repair or hobby needs!



Model 350 Features:

- > Self-centering, extra-wide opening jaws open a full 9" (228.6mm) and hold heavier objects by centering weight over base
- > Parts Tray Base Mount adds stability [8.5" (215.9mm) diameter] and has six individual trays to neatly hold small parts and tools. Includes six non-marring, anti-skid pads
- > Ribbed, neoprene jaw pads are 1.875" (47.6mm) high x 1.5" (38.1mm) wide and provide a sure grip; reverse the pads and the wide "V" holds cylindrical objects
- > Single knob controls head movement through 3-planes: 90° Tilt, 360° Turn & 360° Rotation
- > "Double-action" jaws open/close quickly. Can be reversed to provide 'zero' closure
- > Base accepts all 300 series Heads and any 5/8" (15.9mm) diameter shaft
- > **Height:** 7.875" (200mm), **Weight:** 5.0 lbs. (2.3kg)

Wide Opening Head PanaVise Model 396

The work holding tool with EXPANDED capabilities, perfect for holding larger objects!



Model 396 Features:

- > Wide opening jaws open a generous 6" (152.4mm)
- > Ribbed, neoprene jaw pads are 1.875" (47.6mm) high x 1.5" (38.1mm) wide and provide a sure grip to hold and insulate PC boards and other larger objects; reverse the pads and the wide "V" holds delicate cylindrical objects
- > Single knob controls head movement through 3-planes: 90° Tilt, 360° Turn & 360° Rotation
- > Base accepts all 300 series Heads and any 5/8" (15.9mm) diameter shaft
- > Base features 4.3125" (109.5mm) bolt circle countersunk for three 1/4" (6.3mm) flathead screws (not included)
- > **Height:** 7.3125" (185.7mm), **Weight:** 3.0 lbs. (1.4kg)

Unique Component System

Create a custom work holding tool for your specific needs with the PanaVise system of interchangeable Heads, Bases and Base Mounts. All PanaVise Bases include the patented "split-ball" which allows a Head to be positioned through 3-planes: 90° Tilt, 360° Turn & 360° Rotation. All 300 series Bases accept any 300 series Head — a multitude of useful options at your fingertips!

Heads



PV Jr. Head
Model 203



Standard Head
Model 303



Low Profile Head
Model 304



Circuit Board Holder
Model 315



Fixturing Head
Model 337



Wide Opening Head
Model 366



Extra-Wide Opening Head
Model 376



Micrometer Holder
Model 385

Bases



Low Profile Base
Model 305



Standard Base
Model 300



Vacuum Base
Model 380

Base Mounts



Weighted Base Mount
Model 308



Surface Plate Base Mount
Model 310



Bench Clamp Base Mount
Model 311



Parts Tray Base Mount
Model 312



Magnetic Base Mount
Model 335

Accessories



Jaw Pads
Models 204 & 346



Vise Jaws
Models 343, 344, 352, 353 & 354



Wire Manager
Model 358



Soldering Kit
Model 371

Vise Heads

A new Head will add extra versatility and productivity to your existing Vise, or start here to build your own custom combination! All shafts are 5/8" (15.9mm) in diameter and are compatible with the 300 Standard Base, the 305 Low-Profile Base, and the 380 Vacuum Base (page 13). All of our Vise Heads offer a lifetime of trouble-free service!

PV Jr. Head Model 203

Our most popular Vise Head for arts and crafts, model making, electronics and other small projects!

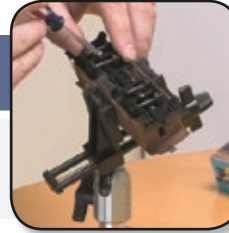

Model 203 Features:

- > We've adapted the PV Jr. Head to fit all 300 series Bases
- > Fine/coarse adjusting knob controls jaw pressure
- > Jaws feature horizontal grooves perfect for holding small tubes, rods, or small circuit boards firmly in place and are made of reinforced thermal composite plastic [continuous heat tolerance to 350°F (177°C), intermittent heat up to 450°F (204°C)]
- > Neoprene Jaw Pads (page 22) are available for holding delicate items
- > Jaws are 2" (50.8mm) tall, 1" (25.4mm) wide and open to 2.875" (73mm)
- > **Height:** 3.75" (95.2mm), **Weight:** 0.4 lbs. (0.2kg)

Standard Head Model 303

Our best selling general purpose Vise Head for hobbies, electronics and small home repairs!



Model 303 Features:

- > Jaws are 2.5" (63.5mm) wide, 0.5" (12.6mm) tall and open to 2.25" (57.1mm)
- > Nylon jaws offer excellent electrical insulation and gentle holding power [continuous heat tolerance up to 200°F (93°C), intermittent heat to 300°F (149°C)]
- > Additional jaws are available for this Head (page 22)
- > Throat depth: 1.375" (34.9mm)
- > **Height:** 4.25" (108.0mm), **Weight:** 1.5 lbs. (0.7kg)

You might consider adding...



Wire Manager Model 358

Keep your wire leads and tools organized! Slides onto 366 Wide Opening Head and 376 Extra-Wide Opening Head (page 11). See page 23 for full specifications.

Low-Profile Head Model 304

Popular for jewelry making, watch repair and lapidary work!



Model 304 Features:

- > Same basic function as the 303 Standard Head (page 10), except that the shaft is cast into the back of the Head. This allows the Head to be positioned more closely to the work surface — great for use under a magnifying light
- > When used with a 305 Low Profile Base (page 13), you can create a very low-profile Vise
- > Features steel jaws. Additional jaws are available for this Head (page 22)
- > Throat depth: 1.375" (34.9mm)
- > **Length:** 7.75" (196.8mm), **Weight:** 1.4 lbs. (0.6kg)

Wide Opening Head Model 366

Hold large objects with this general purpose Vise Head!



Model 366 Features:

- > Jaws pads are 1.875" (47.6mm) high x 1.5" (38.1mm) wide. Opens to 6" (152.4mm) with jaw pads and 6.25" (158.8mm) without jaw pads
- > Ribbed, neoprene jaw pads provide a sure grip and can hold and insulate PC boards and other larger objects; reverse the pads and the wide "V" holds delicate cylindrical objects such as coils and tuners
- > Remove jaw pads from steel jaws when working with high heat
- > Black oxide coating reduces glare and promotes eye comfort
- > **Head Length:** 11" (279.4mm)
- > **Height** (shaft to top of jaw pads): 5.125" (130.2mm), **Weight:** 1.6 lbs (0.7kg)

Extra-Wide Opening Head Model 376

Hold large, heavy objects with this general purpose Vise Head!

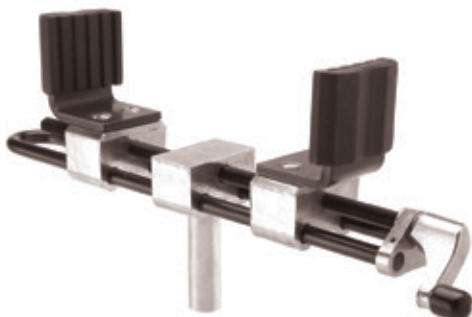

Model 376 Features:

- > Self-centering, extra-wide opening jaws open a full 9" (228.6mm) and hold heavy objects by centering weight over the base
- > Ribbed, neoprene jaw pads are 1.875" (47.6mm) high x 1.5" (38.1mm) wide and provide a sure grip; reverse the pads and the wide "V" holds round or elliptical objects
- > "Double action" jaws open/close quickly. Jaws can be reversed to provide 0" closure
- > Black oxide coating reduces glare and promotes eye comfort
- > **Head Length:** 11.5" (292.1mm)
- > **Height** (shaft to top of jaw pads): 5.25" (133.3mm), **Weight:** 1.9 lbs. (0.9kg)

Circuit Board Holder Model 315

PanaVise Circuit Board Holders help you work quicker & smarter!



Model 315 Features:

- > The two moveable arms extend 6" (154mm) from the cross bar and have "V" shaped grooves which securely hold the board edges
- > One arm is spring tensioned to equalize holding pressure, and includes a lever which locks the internal spring "open" for quick board insertion and removal
- > "V" notches positioned laterally near the arms' tips securely and conveniently hold small electronic parts
- > Shaft is 4.125" (104.8mm) long and 5/8" (15.9mm) in diameter; compatible with all 300 series Bases; accessories available (page 17)
- > **Height** (bottom of shaft to tip of arms): 10.875" (276.2mm), **Weight:** 1.0 lb. (0.5kg)

Fixturing Head Model 337

Exceptional choice for woodworkers and pattern makers!

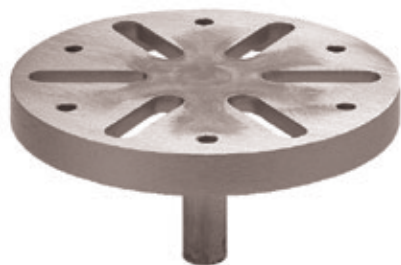

Model 337 Features:

- > Work can be attached easily to this universal Fixturing Head
- > Six slots are 0.4375" (11.1mm) wide and 1.1875" (30.2mm) long; six 0.25" (6.3mm) bolt holes are evenly spaced on a 4.375" (111.1mm) bolt circle
- > Flat surface: 5.375" (136.5mm) in diameter
- > Shaft is 4.125" (104.8mm) long and 5/8" (15.9mm) in diameter; compatible with all 300 series Bases
- > **Height** (shaft to top of head): 3.75" (95.2mm), **Weight:** 11.5oz. (1.3kg)

Micrometer Holder Model 385

Holds a micrometer or small item exactly where YOU want it!

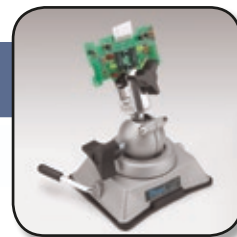
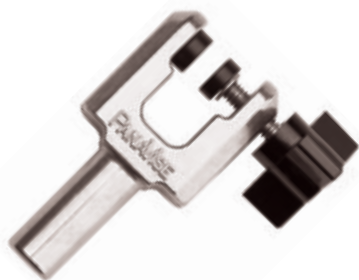

Model 385 Features:

- > Gently, yet firmly, holds micrometers of all sizes. Can also hold small PC boards and other objects
- > Delrin® pads open 0.5" (12.7mm) and close to 0" for holding thin items
- > Throat depth: 0.95" (24.1mm)
- > **Height** (shaft to top of jaws): 3.14" (79.8mm), **Weight:** 0.23 lbs. (0.1kg)

Micrometer Stand Combination Model 391

The 385 Micrometer Holder & 305 Low-Profile Base are available as a pre-selected Micrometer Stand Combination, Model 391.

Vise Bases

Our patented "split-ball" technology is built into every 300 series Vise Base so you can easily "Tilt, Turn & Rotate" your work. Bases are compatible with all 300 series Vise Heads (pages 10-12) and accept any 5/8" (15.9mm) diameter shaft. Models 300 and 305 are compatible with all 300 series Base Mounts (pages 14-15). Mix and match to create the perfect combination!

Standard Base Model 300

Our most popular base!



Model 300 Features:

- > Accepts all 300 series Heads and any 5/8" (15.9mm) diameter shaft
- > Create a versatile work holding system by selecting two or three different Heads!
- > Single control knob and exclusive "split-ball" lock Head firmly in place
- > Base features 4.3125" (109.5mm) bolt circle countersunk for three 1/4" (6.3mm) flat-head screws (not included)
- > **Height:** 3.75" (95.2mm), **Weight:** 1.4 lbs. (0.6kg)



Low-Profile Base Model 305

Lowest Profile Base on the market!



Model 305 Features:

- > Designed for working close to the bench surface
- > Accepts all 300 series Heads and any 5/8" (15.9mm) diameter shaft
- > Use with the 304 Low-Profile Head (page 11) to create a very low-profile vise
- > Single control knob and exclusive "split-ball" locks Head firmly in place
- > Base features 4.3125" (109.5mm) bolt circle countersunk for three 1/4" (6.3mm) flat-head screws (not included)
- > **Height:** 2.5" (63.5mm), **Weight:** 1.3 lbs. (0.6kg)



Vacuum Base Model 380

Create the world's most PORTABLE work holding tool!



Model 380 Features:

- > Our Vacuum Base is in wide use for portable applications. Simply flip the lever to "activate" the rubber pad and attach the unit to any smooth, non-porous surface
- > Accepts all 300 series Heads and any 5/8" (15.9mm) diameter shaft
- > Pad footprint measures 5.125" x 4.25" (130.2mm x 108mm)
- > Single control knob and exclusive "split-ball" locks Head firmly in place
- > **Height:** 3.25" (82.5mm), **Weight:** 1.7 lbs. (0.8kg)



Vise Base Mounts

Whether you already own a 300 series Vise or are selecting components to build your own custom work holding tool, our Base Mounts will add versatility and productivity to your next PanaVise project! **All Base Mounts include three flathead mounting screws.**

Weighted Base Mount Model 308

Add portability & stability to your Vise for light duty work!

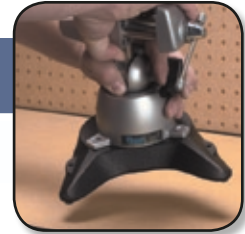

Model 308 Features:

- > This husky, cast iron Base Mount is compact and features two extensions for extra stability
- > Compatible with the 201 PV Jr. Vise (page 6) and 300 & 305 Bases (page 13)
- > Includes four non-marring, anti-skid pads
- > Two 1/4-20 holes are drilled and tapped on the side extensions for mounting accessories such as the 371 Solder Station (page 23)
- > **Overall dimensions:** 6.875" deep x 7.5" wide (174.6mm x 190.5mm)
- > **Height** (with pads): 1.1875" (30.2mm), **Weight:** 5.0 lbs. (2.3kg)

Surface Plate Base Mount Model 310

When you need a portable, stable Vise!

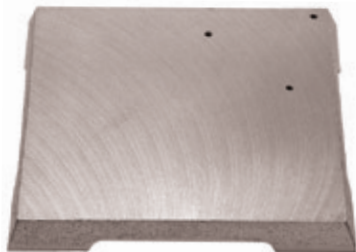

Model 310 Features:

- > The 310 Surface Plate Base Mount has a precision cast iron flat surface (Blanchard ground) which is ideal for layout work and for use as a portable work station
- > Square surface: 10.75" x 10.75" (273.1mm x 273.1mm)
- > Compatible with the 201 PV Jr. Vise (page 6) and 300 & 305 Bases (page 13)
- > Includes four non-marring, anti-skid pads
- > **Height:** 1.25" (31.8mm), **Weight:** 10.0 lbs. (4.5kg)

Bench Clamp Base Mount Model 311

Clamp your Vise to a table, workbench or ladder...



Model 311 Features:

- > Clamps to anything up to 3.4375" (87.3mm) thick
- > Compatible with the 201 PV Jr. Vise (page 6) and 300 & 305 Bases (page 13)
- > Includes four non-marring, anti-skid neoprene pads for additional anti-slip characteristics without excessive tightening of the clamping screw. Finger grip for added convenience
- > Throat depth from center of clamping screw: 2.3125" (58.7mm)
- > **Weight:** 2.4 lbs. (1.1kg)

PanaVise Base Mounts can be added to any Vise combination that includes our 300 Standard Base or our 305 Low-Profile Base; they are also compatible with the 201 PV Jr. Vise. All Base Mounts are guaranteed to deliver a lifetime of quality service!

Parts Tray Base Mount Model 312

Neatly organizes your small parts and tools!



Model 312 Features:

- > Cast aluminum Base Mount adds stability and has six integral parts wells with rounded and sloped walls for easy parts removal
- > Compatible with the 201 PV Jr. Vise (page 6) and 300 & 305 Bases (page 13)
- > Includes six non-marring, anti-skid pads
- > Three 1/4-20 holes are drilled and tapped on the outer lip for mounting accessories such as the 371 Solder Station (page 23)
- > **Overall diameter:** 8.5" (215.9mm)
- > **Height:** 0.75" (19.1mm), **Weight:** 1.9 lbs. (0.9kg)

Magnetic Base Mount Model 335

Magnetically attach your PanaVise to any flat, ferrous metal surface!



Model 335 Features:

- > Compatible with the 201 PV Jr. Vise (page 6) and 300 & 305 Bases (page 13)
- > Perfect for attaching work holding tools on machinery, truck beds, tool boxes, file cabinets... anywhere magnets are not a problem
- > Magnet is slightly recessed into Base Mount to avoid scratching metal surfaces
- > Magnetic power holds up to 5 lbs. (2.3kg) at 90°
- > **Overall diameter:** 4.32" (2.28mm)
- > **Height:** 0.5" (12.7mm), **Weight:** 1.0 lbs. (0.4kg)

You might consider adding...



Solder Station Model 371

Keep your iron and solder close at hand! Designed for use with the 312 Parts Tray Base Mount (see above) and the 308 Weighted Base Mount (see page 14). Combines a soldering iron holder, controlled-feed solder/wire holder (for standard sized spools), and two nib sponges with self-purging slits. See page 23 for full specifications.

Circuit Board Holders

The moveable arms on all PanaVise Circuit Board Holders extend 6" (152.4 mm) from the cross bar. "V" shaped grooves securely hold the board edge. The spring-tensioned arm equalizes holding pressure and the lever locks the arm open for quick board insertion and removal. "V" notches positioned near the arms' tips conveniently hold small electronic parts.

Circuit Board Holder Model 315

PanaVise Circuit Board Holders help you work quicker and smarter!



Model 315 Features:

- > Hold circuit boards up to 12" (304.8mm) wide and up to 0.156" (4mm) thick
 - Arms move independently
- > Ratcheted pivot holds board horizontally, vertically or any angle in between
- > See Circuit Board Accessories (page 17)
- > Shaft is 4.125" (104.8mm) long and 5/8" (15.9mm) in diameter; compatible with all 300 series Bases
- > **Height** (bottom of shaft to tip of arms): 10.875" (276.2mm),
- > **Weight:** 1.0 lb. (0.5kg)

Electronic Work Center Model 324

Make work areas more efficient and manageable!



Model 324 Features:

- > The PanaVise Electronic Work Center is a complete and economical work station combination
- > This practical, pre-assembled combination includes a 315 Circuit Board Holder (see above), a 300 Standard Base (page 13), a 312 Parts Tray Base Mount (page 15), and a 371 Solder Station (page 23)
- > Single control knob and exclusive "split-ball" lock the Circuit Board Holder firmly into place
- > Release the knob pressure and Circuit Board Holder Tilts 90°, Turns 360° & Rotates 360° and can be easily removed from the base. Base is compatible with all 300 series Heads (pages 10-12)
- > **Height:** 13.5" (342.9mm)
- > **Weight:** 4.5 lbs. (2kg)

All PanaVise Circuit Board Holders have plenty of head movement, including the ability to rotate quickly and easily from front to back. This makes it easy to insert and solder components, and to flip the board around for QC work. All Circuit Board Holders will provide a lifetime of superior service.

Rapid Assembly Circuit Board Holder Model 333

Speed your production work!

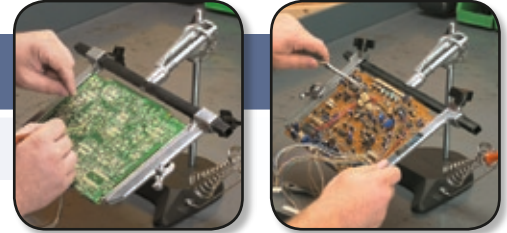

Model 333 Features:

- > For quick circuit board rotation and component insertion/soldering, the Rapid Assembly Circuit Board Holder features eight rotating adjustment positions at the head, six positive lock positions in the vertical plane, and variable height adjustment
- > Hold circuit boards up to 12" (304.8mm) wide and up to 0.156" (4mm) thick. — Arms move independently
- > "V" notches positioned laterally near the arms' tips securely and conveniently hold small electronic parts
- > 5.0 lb Weighted Base is extremely stable
- > **Height** (base to top of vertical shaft): 10" (254mm), **Weight:** 6.4 lbs. (2.9kg)

Circuit Board Accessories

Expand the capability of your PanaVise Circuit Board Holder with these outstanding accessories!

Circuit Board Arms Model 316

Add a set of arms to work on multiple boards!



- > Compatible with all Circuit Board Holders
- > Includes left and right arm
- > Arms extend 6" (152.4mm) from cross bar

Replacement Knobs Model 319

Missing a knob? Replacements are available!



- > For use with the:
 - 315 Circuit Board Holder
 - 333 Rapid Assembly Circuit Board Holder
 - 324 Electronic Work Center

Circuit Board Cross Bars Models 318-14 thru 318-30

Add longer cross bars for wider circuit boards!



- > For use with the 315 Circuit Board Holder, 333 Rapid Assembly Circuit Board Holder, and 324 Electronic Work Center
- > Available in 4" (101.6mm) increments from 14" (304.8mm) to 30" (762mm)
- > When selecting a crossbar, add a minimum of 2" (50.8mm) to your widest circuit board width to accommodate Circuit Board Arms

PanaPress and Accessories

Our precision 1/4 ton (227kg) PanaPress (arbor press) is extremely useful in manufacturing or as a repair tool. By adding Retrofit Kits, you can quickly and efficiently convert a standard PanaPress into an IDC Bench Assembly Press or a Crimp Press.

PanaPress Model 502

Ideal for pressing bearings, sleeves, collars, forming and assembling small parts, broaching, staking, etc...

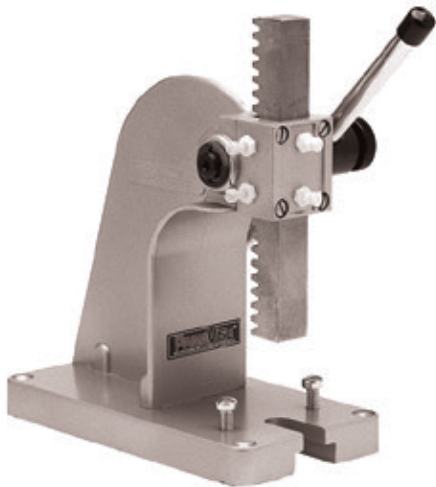
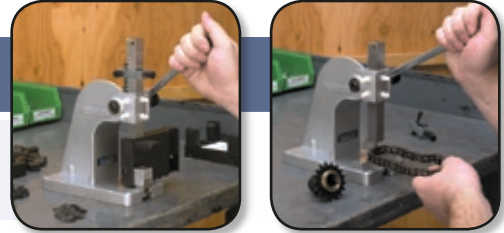

Model 502 Features:

- > Reversible ram applies up to 1/4 ton (500 lbs. / 227kg) of pressure and is 0.75" x 0.75" (19.1mm x 19.1mm) square and 5.875" (149.2mm) long
- > One end of the ram is reamed 0.251" (6.4mm) for adding tooling
- > Four adjustable nylon gibs provide exceptional ram control
- > Arm is 8" (203.2mm) long
- > Base footprint is 3.7" x 7" (94mm x 177.8mm) and includes four 0.25" (6.3mm) holes countersunk at the corners for bolting to a work surface
- > Two additional holes for mounting Retrofit Kits on the base are pre-drilled and tapped 1/4-20 and may be used for customer tooling
- > **Height** (from base to top of back – not including variable ram height or arm length): 7" (177.8mm), **Weight:** 5.4 lbs. (2.5kg)

IDC Bench Assembly Retrofit Kit Model 506

Convert any PanaPress into a rugged Insulation Displacement Connector (IDC) Assembly Press!



506 Kit installed on 502 PanaPress



Model 506 Features:

- > Perfect for independent repair technicians and in-house service departments; perfect for low volume, mass termination of various IDC connectors on ribbon cable
- > Retrofit Kit includes IDC base (for holding IDC Base Plates), ram adapter (for applying even pressure across a connector), cable guide, mounting screws and allen wrench
- > Smoothly and securely terminates up to 64-pin conductor cable
- > More effective than hand crimpers (eliminates the "scissor effect")
- > Helps prevent injuries to wrist, hands, nerves and tendons
- > Interchangeable base plates and flat ribbon cable cutter are available (page 20)

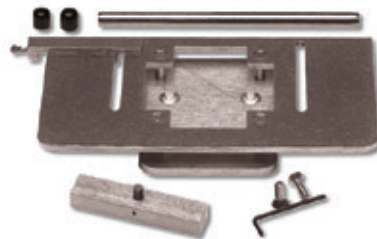

506 Retrofit Kit.
(PanaPress sold separately.)

The PanaPress can be found in a variety of work environments including manufacturing, jewelry/watch repair, and service centers. PanaPress accessories expand the capabilities of your PanaPress and will deliver a lifetime of quality service.

Crimp Press Retrofit Kit Model 561

Convert any PanaPress into a convenient Crimp Press to eliminate wrist fatigue!



561 Kit installed on 502 PanaPress



Model 561 Features:

- > Includes longer, 12" lever for increased leverage ratio over standard 502 PanaPress, crimp die holders, all mounting hardware and two allen wrenches to ease installation
- > Designed to assist in-house service departments, independent technicians, and medium-volume manufacturers

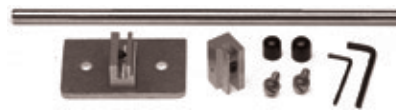

561 Retrofit Kit.
(PanaPress sold separately.)

- > Accepts all industry standard crimp die sets
- > High leverage ratio helps prevent injuries to the wrist, hands, nerves and tendons
- > More effective than hand crimpers (completely eliminates the "scissor effect")

PanaPress Posi-Stop Model 570

Adjustable Positive Stop for ALL PanaVise Presses precisely controls ram depth!

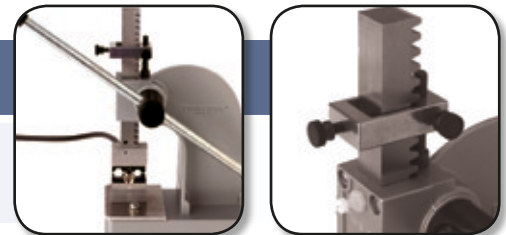

Model 570 Features:

- > Accurately controls where the ram will stop its motion
- > Quickly and easily slips over ram
- > Easy-to-use coarse adjustment firmly locks the Posi-Stop in place
- > Fine precision adjustment stops the ram exactly where you want it

Replacement Guide Arm Model 532

Add an extra guide arm when precision is critical!



- > Use two guide arms for precise cable alignment
- > Identical to the Guide Arm included with the 506 Retrofit Kit

IDC Assembly Press Accessories

A complete selection of IDC Base Plates, Cutters and Replacement Blades are available for the IDC Bench Assembly Press [(502 PanaPress with 506 Retrofit Kit (page 18)]. Useful for all independent technicians, in-house repair departments, or short run manufacturers!

IDC Base Plates Models 510-513

Interchangeable IDC Base Plates for quick cable termination!

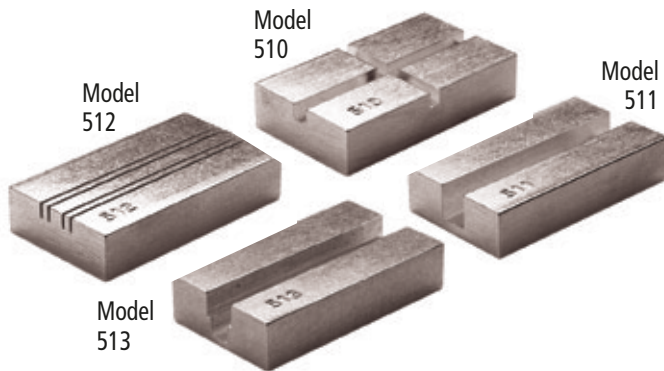

Model 510-513 Features:

- > IDC Base Plates are custom cut to hold a wide variety of connectors
- > Base Plates fit into IDC Base (included with 506 Retrofit Kit); insert and remove various Base Plates as needed

Female Socket Transition Connectors	510 series
Card Edge Connectors	511 series
DIP Plugs	512 series
D-Sub Connectors	513 series

For specific applications: call PanaVise for a dimension specification sheet which is used to determine the correct Base Plate for your needs. If you require a Base Plate that is not currently produced, call or e-mail us for information on how we can make a base plate to satisfy your requirements (Toll Free: 1.800.759.7535 -or- email: sales@panavise.com).

Flat Ribbon Cable Cutter Model 507

Perfect right angle cuts, every time!

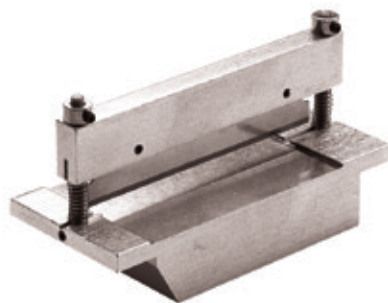

Model 507 Features:

- > Accommodates up to 68-pin conductor cable
- > More efficient than hand scissors; won't pull inner wires
- > Easy to use and operate, slips into the 502 PanaPress with the 506 Retrofit Kit
- > Spring-loaded blade arm returns quickly to original position
- > Accommodates ribbon cable up to 3.21875" (81.8mm) wide and up to 14-gauge thick

Replacement Blades Model 530

Keep a sharp edge for precision cuts!

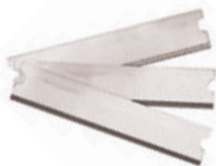

- > Replacement blades available for the 507 Cable Cutter
- > Three per blister pack

Heavy Duty Vise

For working on heavier objects such as lawn mower and electrical motors, or for wood carving and chiseling, we recommend 400 Heavy Duty Vise series components. The Heavy Duty Base provides all the "Tilt, Turn & Rotate" found in the 300 series, but with extra holding power! The Heavy Duty Head provides an exceptional work platform.

Heavy Duty Base Model 400

For heavy duty projects requiring added holding power!



Model 400 Features:

- > Recent engineering improvements allow the 400 Base to support weights up to 75 lbs. (34.0kg) at 45°
- > Recommended for use with the 437 Heavy Duty Fixturing Head (see below)
- > Accepts any 1" (25.4mm) diameter shaft to a depth of 1.7" (43.2mm)
- > Single knob controls head movement through 3-planes: 90° Tilt, 360° Turn & 360° Rotation
- > Square base [4.125" x 4.125" (104.8mm x 104.8mm)] has four 0.3125" (7.9mm) mounting holes (mounting screws not included)
- > A hole is provided in the bottom of the base for a 1/4-20 flat head screw to permanently attach any shaft
- > **Height:** 3.25" (82.5mm), **Weight:** 1.5 lbs. (0.7kg)

Heavy Duty Head Model 437

A rugged Fixturing Head for heavy duty projects!



Model 437 Features:

- > Recommended for use with the 400 Heavy Duty Base (see above)
- > Four "universal" slots 0.29" (7.37mm) wide for attaching forms, parts, etc...
- > Flat Head is 3" x 6" (76.2mm x 152.4mm)
- > Shaft is 1" (25.4mm) in diameter and 3.25" (82.5mm) long. Shaft is drilled and tapped 1/4-20 (screw included) for permanently securing to base
- > **Height** (bottom of shaft to top of head): 4" (101.6mm), **Weight:** 0.86 lbs. (0.4kg)

Vise Accessories

Thanks to ongoing customer input, we've added important accessories to our product line and have made replacement parts available. If you have an idea or suggestion for an accessory or replacement part not shown here, please contact a PanaVise representative.

Interchangeable Jaws Models 343, 344, 352-354

Interchangeable Jaws for the 303 Standard and 304 Low-Profile Heads create the perfect Vise for the job!

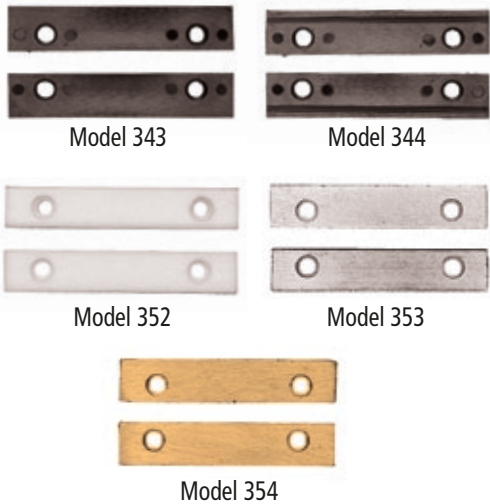

Nylon Jaws Model 343

- > Type 6/6 Nylon Jaws offer excellent electrical insulation and gentle holding power
- > Continuous heat tolerance to 200°F (93°C), intermittent heat to 300°F (149°C)

Grooved Nylon Jaws Model 344

- > Same heat properties as 343 Nylon Jaws but with thin horizontal grooves, perfect for holding small tubes, rods, or small circuit boards firmly in place

Teflon® High Heat Jaws Model 352

- > Recommended for high heat applications; won't scratch or mar delicate pieces
- > Continuous heat tolerance to 500°F (260°C)

Plated Steel Jaws Model 353

- > Designed for firmly holding heavier objects in a high heat environment

Brass Jaws Model 354

- > Non-marring alternative for heavy or high heat applications

Neoprene Jaw Pads Models 204 & 346

Neoprene Pads are soft but have plenty of holding power!

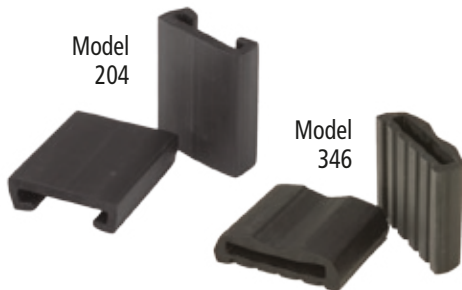

Neoprene Jaw Pads Model 204

For Models 201, 209 & 203 PV Jr. Head

- > Firmly hold your projects while protecting finished surfaces

Neoprene Jaw Pads Model 346

For Models 366 & 376 Heads

- > Thick, molded pads have a corrugated surface on one side to firmly hold the most delicate objects
- > Reverse the pads and use the wide "V" groove to hold round objects
- > Jaw Pads are 1.875" (47.63mm) wide x 1.5" (38.1mm) tall

Our Wire Manager and Solder Station are specifically designed for the electronics professional and serious hobbyist. Our goal is to make your work space more efficient — now you can take control of your wire leads and keep your soldering equipment close at hand.

Wire Manager Model 358

A handy time saver that keeps your leads and tools organized!



Model 358 Features:

- > Tempered steel spring, zinc plated
- > Pivots away from the jaws when not in use
- > Slides onto 366 Wide Opening Head and 376 Extra-Wide Opening Head (page 11)
- > **Spring width:** 3.375" (85.7mm). **Height:** 1.13" (28.7mm)



Solder Station Model 371

Keep your soldering iron and solder close at hand!



Model 371 Features:

- > Combines a soldering iron holder, controlled-feed solder/wire holder (for standard-sized spools), and two nib sponges with self-purging slits
- > Attaches easily to the 312 Parts Tray Base Mount (page 15) or to the 308 Weighted Base Mount (page 14). Mounting screws/nuts are included
- > May also be used as a freestanding unit and is easily attached to a bench or wall

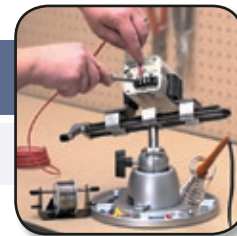

Vacuum Base Repair Kit Model 380-RK

Repair your torn or damaged Vacuum Base pad!



Model 380-RK Features:

- > To determine if your Vacuum Base needs replacing, clean the pad with a clean towel and make sure that is free of debris. Then attach it to a clean, non-porous surface (such as a window). If it still loses suction, the pad needs to be replaced.
- > Includes rubber pad, handle and lock washer
- > For 380 Vacuum Base (page 13) or 381 Vacuum Base PanaVise (page 7)





CCTV Camera Mounts

> Innovative Holding Solutions™

Tilt, Turn & Rotate

Our Visés are not the only products that Tilt, Turn & Rotate! All of our CCTV camera mounts have plenty of adjustability — right out of the box. There's a camera mount for every installation requirement.

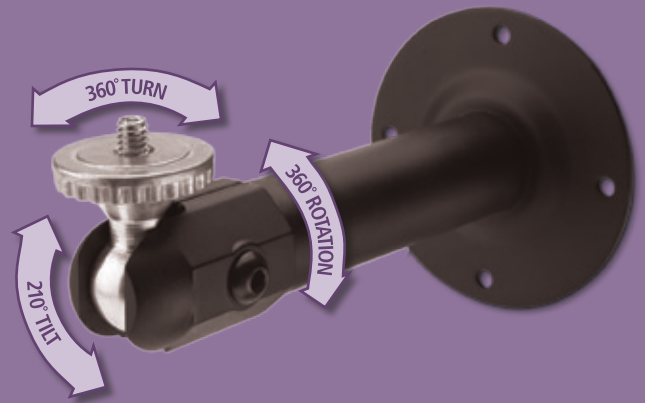

Deluxe Mounts

Our Deluxe Mounts are the only CCTV mounts with two adjusting points. Deluxe Mounts (page 30) are the most adjustable mounts on the market today!



Flex Mounts

PanaVise Flex Mounts have double-wound shafts that will stay where you put them (page 32). Perfect for navigating tricky installs.



Specialty Mounting

Our complete line of innovative CCTV Camera Mounts are designed for professional installers and will simplify the most challenging projects.



Telescoping Mounts

With PanaVise Telescoping Mounts, you can even adjust the shaft length AFTER the camera has been installed (page 31).

NEXT >>>

Small Camera Mounts

For today's smaller cameras, choose from the PanaVise Micro Mount series featuring plenty of built-in options and style. All Micro Mounts are fully adjustable, won't slip when properly installed, and are manufactured from quality components. They're the value priced solution for all your smaller camera installations!

Standard Micro Mount Models 846-06...

Excellent for any standard installation that uses smaller cameras!



Standard Micro Mount Black Model 846-06
Standard Micro Mount Cream Model 846-06W

- > 0.5" (12.7mm) diameter solid steel shaft
- > 1/4-20 mounting stud with locking
- > Fully adjustable at the camera (190° Tilt, 360° Turn & 360° Rotation)
- > Knob and tamper-resistant set-screw adjusting options included. Matching vinyl cover adds a finished look!
- > 6" (152.4mm) overall length
- > 2" (50.8mm) round base with four 0.188" (4.8mm) holes on 1.6" (40.6mm) bolt circle



Includes knob, set-screw with hex key, and vinyl base cover

Pass Thru Micro Mount Models 848-06...

A smaller mount with a hollow shaft for crisp, clean installs!



Pass Thru Micro Mount Black Model 848-06
Pass Thru Micro Mount Cream Model 848-06W

- > Hollow aluminum shaft [0.5" (12.7mm) outside diameter; 0.375" (9.5mm) inside diameter] with slot for cable pass thru
- > Pass thru slot is 0.375" x 0.625" (9.5mm x 15.9mm)
- > 1/4-20 stud with locking
- > Fully adjustable at the camera (190° Tilt, 360° Turn & 360° Rotation)
- > Knob and tamper-resistant set-screw adjusting options included. Matching vinyl cover adds a finished look!
- > 6" (152.4mm) overall length
- > 2" (50.8mm) round base with four 0.1875" (4.8mm) holes on a 1.6" (40.6mm) bolt circle



Includes knob, set-screw with hex key, and vinyl base cover

PanaVise recommends a maximum camera weight of three pounds when using our Micro Mounts series (pages 26-28). Every mount is designed for a perfect installation. When you're on your way to the next job, take along PanaVise CCTV camera mounts — they're ready to install when you are!

Deluxe Micro Mount Models 845-246...

Our most versatile mount ever... twelve different options with one amazing result!



Deluxe Micro Mount Black Model 845-246

Deluxe Micro Mount Cream Model 845-246W

- > Modular system: Base, Shaft and Head screw together
- > Solid steel Shafts [0.5" (12.7mm) diameter] will make a 2" (50.8mm), 4" (101.6mm) or 6" (152.4mm) long mount. 1/4-20 stud with locking
- > Fully adjustable at the camera (190° Tilt, 360° Turn & 360° Rotation)
- > Knob and tamper-resistant set-screw adjusting options included. Matching vinyl cover adds a finished look!
- > Includes 2" (50.8 mm) round Base with four 0.188" (4.8mm) holes on 1.6" (40.6mm) bolt circle for solid surface mounting, and a T-Bar Clip for drop ceiling rails

The Model 845-246 kit makes any one of these 12 mounting combinations!

Angle Micro Mount Models 846L...

Another great choice for the perfect camera installation!

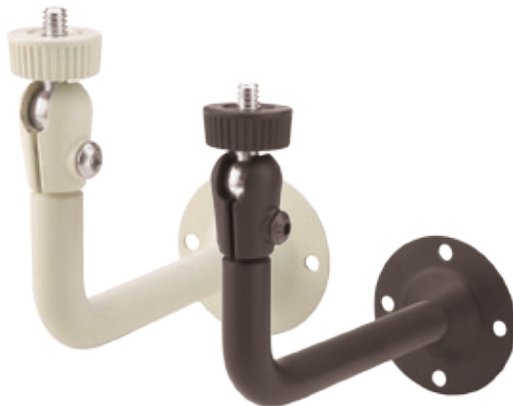

Angle Micro Mount Black Model 846L

Angle Micro Mount Cream Model 846LW

- > 0.5" (12.7mm) diameter solid steel shaft
- > Length of mount from base to front of mount: 4.0" (102mm)
- > Length of mount from bottom of angle to top of mount: 3.375" (85.7mm)
- > 1/4-20 stud with locking; adjustable at the camera (190° Tilt, 360° Turn & 360° Rotation)
- > Knob and tamper-resistant set-screw adjusting options included. Matching vinyl cover adds a finished look!
- > 2" (50.8mm) round base with four 0.188" (4.8mm) holes on 1.6" (40.6mm) bolt circle



Includes knob, set-screw with hex key, and vinyl base cover

J-Box Mounts

Below is complete line of quality mounts designed for single-gang electrical box or solid surface installations. If you're a professional installer, you'll appreciate the versatility and agree that PanaVise delivers the mounts you need for consistently clean, expert installations with no hassles.

Pass Thru J-Box Standard Mount Models 899-06...

Larger J-Box mount with cable pass thru!



Pass Thru J-Box Standard Mount Black Model 899-06
Pass Thru J-Box Standard Mount Cream Model 899-06W

- > Hollow aluminum shaft [1.0" (25.4mm) outside diameter; 0.875" (22.2mm) inside diameter] with slot for cable pass thru
- > Round pass thru hole is 0.625" (15.9mm) in diameter
- > 1/4-20 mounting stud with locking
- > Fully adjustable at the camera (210° Tilt, 360° Turn & 360° Rotation)
- > Integral J-Box mounting plate
- > Knob and tamper-resistant set-screw adjusting options included
- > 6" (152.4mm) overall length (from base to top of locking)



Pass Thru J-Box Micro Mount Models 898-06...

Smaller J-Box mount with cable pass thru!

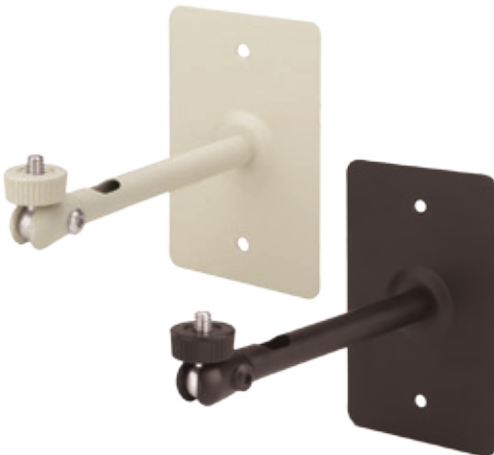
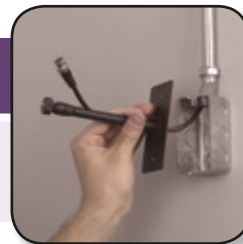

Pass Thru J-Box Micro Mount Black Model 898-06
Pass Thru J-Box Micro Mount Cream Model 898-06W

- > Hollow aluminum shaft [0.5" (12.6mm) outside diameter; 0.375" (9.5mm) inside diameter] with slot for cable pass thru
- > Pass thru slot is 0.375" x 0.625" (9.5mm x 15.9mm)
- > 1/4-20 mounting stud with locking
- > Fully adjustable at the camera (190° Tilt, 360° Turn & 360° Rotation)
- > Integral J-Box mounting plate
- > Knob and tamper-resistant set-screw adjusting options included
- > 6" (152.4mm) overall length (from base to top of locking)



PanaVise is the only camera mount manufacturer that continues to produce options based on input from professional installers. Our representatives attend major security trade shows not only to display our latest products, but to listen to input from our customers. The CCTV Camera Tree, shown on this page, was developed in response to those needs.

Standard J-Box Mount Models 897...

Our ORIGINAL J-Box mount!

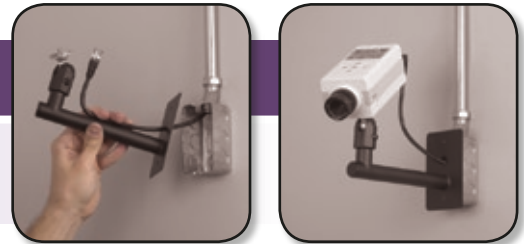

Standard J-Box Mount Black Model 897
Standard J-Box Mount Cream Model 897W

- > Steel shaft is 0.875" (22.2mm) in diameter (hollow for lighter weight)
- > 1/4-20 mounting stud with lockring
- > Fully adjustable at the camera (210° Tilt, 360° Turn & 360° Rotation)
- > Ball swivel is 6.25" (158.8mm) from wall
- > Height of adjusting point is 3.5" (89mm)
- > Integral J-Box mounting plate with 0.625" (15.9mm) cable pass thru hole
- > Knob and tamper-resistant set-screw adjusting options included



Includes knob and set-screw with hex key

CCTV Camera Tree Models 870...

A single mounting solution for multiple cameras — perfect for warehouses and auditoriums!

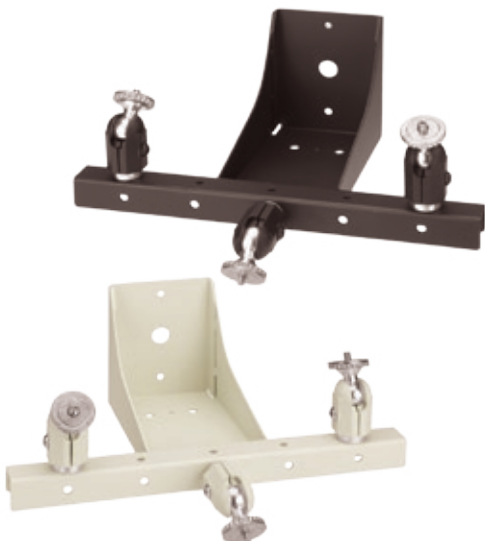

Camera Tree Black Model 870
Camera Tree Cream Model 870W

- > Heavy duty, steel construction
- > Includes three adjusting knuckles (1/4-20 studs with lockrings)
- > Fully adjustable at the cameras (210° Tilt, 360° Turn & 360° Rotation)
- > Distance from wall to center of cross bar is 6.25" (158.8mm)
- > Height of adjusting knuckles is approx. 2.75" (69.8mm)
- > Integral J-Box mounting plate with 0.625" (15.9mm) round cable pass thru hole
- > Knob and tamper-resistant set-screw adjusting options included with each knuckle
- > Cable channel includes tie-down holes. Mount bar is 12" (304.8mm) wide; adjusting knuckles can mount on top or front
- > Additional adjusting knuckles available (page 35)



Includes knob and set-screw with hex key

Standard Camera Mounts

PanaVise makes the most versatile line of CCTV Camera Mounts in the security industry and is dedicated to providing the superior quality that professional installers demand. Whether you want mounts with two adjusting points or mounts with a cable pass thru, PanaVise has the innovative solution!

Deluxe Mount Models 827...

Two adjusting points for maximum positioning power!



- Deluxe Mount 6" (152.4mm)** **Black** Model 827-06
- Deluxe Mount 6" (152.4mm)** **Cream** Model 827-06W
- Deluxe Mount 9" (228.6mm)** **Black** Model 827-09
- Deluxe Mount 9" (228.6mm)** **Cream** Model 827-09W

- > Both adjusting points have a full range of motion: 210° Tilt, 360° Turn & 360° Rotation
- > 1/4-20 mounting stud with lockring
- > Shafts are machined aluminum alloy 0.875" (22.2mm) in diameter
- > Knob and tamper-resistant set-screw adjusting options included
- > Square mounting base for solid surfaces, 2.5" x 2.5" (63.5mm x 63.5mm), with four 0.219" (5.56mm) holes on 2.0" (50.8mm) x 2.0" (50.8mm) layout



Pass Thru Standard Mount Models 849-06...

Our standard mount with cable pass thru!



- Pass Thru Standard Mount** **Black** Model 849-06
- Pass Thru Standard Mount** **Cream** Model 849-06W

- > Hollow aluminum shaft [1.0" (25.4mm) outside diameter; 0.875" (22.2mm) inside diameter] with hole for cable pass thru
- > Round pass thru hole is 0.625" (15.9mm) in diameter
- > 1/4-20 mounting stud with lockring
- > Fully adjustable at the camera: 210° Tilt, 360° Turn & 360° Rotation
- > Knob and tamper-resistant set-screw adjusting options included
- > 3" (76.2mm) round mounting base for solid surfaces with four 0.188" (4.8mm) holes on a 2.5" (63.5mm) circle
- > 6" (152.4mm) overall length (from base to top of locking)



You'll never be without the right mount when you take along Dual Option Mounts from PanaVise. Easy to use, each mount includes a solid surface and T-Bar clip base option. When you use Dual Option Mounts, you'll always have the right mounting style close at hand!

Dual Option Mount Models 883...

Avoid surprises — with two mounting options, we've got you covered!



Dual Option Mount 3" (76.2mm)	Black	Model 883-03
Dual Option Mount 3" (76.2mm)	Cream	Model 883-03W
Dual Option Mount 6" (152.4mm)	Black	Model 883-06
Dual Option Mount 6" (152.4mm)	Cream	Model 883-06W
Dual Option Mount 9" (228.6mm)	Black	Model 883-09
Dual Option Mount 9" (228.6mm)	Cream	Model 883-09W

- > Includes two mounting bases that screw easily into the machined aluminum alloy shaft [0.875" (22.2mm) in diameter]
- > Use the Tri-Foot Base [4" (101.6mm) outside diameter with three 0.265" (6.7mm) holes on a 3.25" (82.5mm) bolt circle] for solid surfaces, or the T-Bar Clip for drop ceiling rails
- > Full range of motion at the camera: 210° Tilt, 360° Turn & 360° Rotation
- > Knob and tamper-resistant set-screw adjusting options included
- > 1/4-20 mounting stud with locking



Includes knob and set-screw with hex key

Dual Option Telescoping Mount Model 883T

Adjust the shaft length after the camera is installed!



Includes knob and set-screw with hex key

Dual Option Telescoping Mount **Black Only** Model 883T

- > Adjustable shaft: overall mount length from 9.375" (238.1mm) to 13.625" (346.1mm)
- > Shaft locks tightly and is indexed to prevent rotation
- > Use the Tri-Foot Base [4" (101.6mm) outside diameter with three 0.265" (6.7mm) holes on a 3.25" (82.5mm) bolt circle] for solid surfaces, or the T-Bar Clip for drop ceiling rails
- > Full range of motion: 210° Tilt, 360° Turn & 360° Rotation
- > 1/4-20 mounting stud with locking
- > Knob and tamper-resistant set-screw adjusting options included

Specialty Camera Mounts

Our unique line of specialty camera mounts are perfect for professional installers who require innovative solutions. Whether you're installing an in-vehicle camera system for a private detective, winding your way around a permanent obstacle, or dropping cameras from warehouse ceilings, we've got a camera mount to meet your needs!

Window Mount Model 809

For temporary surveillance or in-car video systems!



CCTV Camera Window Mount Black Only Model 809

- > Quickly move cameras from vehicle-to-vehicle or location-to-location
- > Powerful suction pad attaches to any smooth, flat, non-porous surface including windshields, windows and two-way mirrors
- > Full range of motion at the camera (knob adjustment):
210° Tilt, 360° Turn & 360° Rotation — 1/4-20 stud with lockring
- > Ratcheted arm has 140° vertical motion; knob locks arm into place
- > Suction pad is 3.4" (86.4mm) in diameter
- > Overall length is approximately 4.5" (114.3mm)
- > Recommended for cameras weighing up to 3 lbs. (1.4kg)

Flex Mount Models 817...

For working around corners and other obstacles!



Includes knob and set-screw with hex key

Flex Mount, 13" (330.2mm) Black Only Model 817-13 Flex Mount, 16" (406.4mm) Black Only Model 817-16

- > Double wound shaft will not droop or require safety wires
- > Shaft is covered with durable black vinyl
- > Full range of motion at the camera: 210° Tilt, 360° Turn & 360° Rotation
- > 1/4-20 mounting stud with lockring
- > Knob and tamper-resistant set-screw adjusting options included
- > Base accepts shaft in vertical or horizontal position

You might consider adding...



Flex Adapter Model 817-A

The Flex Adapter allows you to connect the threaded end of the Flex Mount shafts shown above to any of our unique Bases (page 34), including the T-Bar Clip and Magnetic Base. Bases sold separately.

These clever Conduit Mounts allow you to create a camera mount in any length you need! Designed for long drops, simply select the length of pipe you need and the preferred diameter, and you'll have excellent cable management with a clean install. Perfect for warehouses, convention centers, auditoriums, etc...

Micro Conduit Mount Models 847...

Mount CCTV cameras to any length conduit or pipe — quickly and easily!



Micro Conduit Mount Micro Conduit Mount

Silver Only 1/2" Conduit Model 847-1/2
Silver Only 3/4" Conduit Model 847-3/4

- > For smaller CCTV cameras weighing up to 3 lbs. (1.4kg)
- > For 1/2" (12.7mm) or 3/4" (19.1mm) conduit or NPT pipe installs
- > Length from center of flange to center of shaft: 3.5" (88.9mm)
- > Overall mount length: 3.125" (79.4mm)
- > Adjusting point features 210° Tilt, 360° Turn & 360° Rotation
- > 1/4-20 mounting stud with lockring
- > Includes both knob and set-screw adjusting options
- > Steel conduit locknut required (two included)

Standard Conduit Mount Models 854...

Long drops are no problem for our new Conduit Mounts!

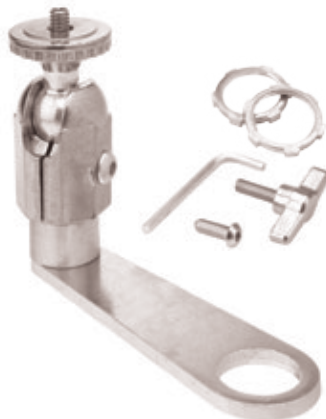

Standard Conduit Mount Standard Conduit Mount

Silver Only 1/2" Conduit Model 854-1/2
Silver Only 3/4" Conduit Model 854-3/4

- > For standard CCTV cameras weighing up to 5 lbs. (2.3kg)
- > For 1/2" (12.7mm) or 3/4" (19.1mm) conduit or NPT pipe installs
- > Length from center of flange to center of shaft: 3.5" (88.9 mm)
- > Overall mount length: 3.125" (79.4mm)
- > Adjusting point features 210° Tilt, 360° Turn & 360° Rotation
- > 1/4-20 mounting stud with lockring
- > Includes both knob and set-screw adjusting options
- > Steel conduit locknut required (two included)

You might consider adding...



Extension Shafts Model 848-03NP; 856-03NP

Add 3" (76.2mm) to the length of a Conduit Mount quickly and easily! Use the 848-03NP Shaft for the 847 series and the 856-03NP Shaft for the 854 series.

Custom Component System

With the PanaVise Custom Component System, you can build your own unique CCTV Camera Mounts or solve installation problems on the spot. With our easy-to-use modular components, it's as simple as 1-2-3: **1) Select a Base, 2) Select a Shaft, 3) Select an Adjusting Knuckle.**

1. Select a Base

Choose one of our six unique bases for mounting to a variety of surfaces!



Tri-foot Base Black Model 860
Tri-foot Base Cream Model 860W

- > Tri-foot Base with three 0.265" (6.7mm) holes on a 3.25" (82.5mm) bolt circle; 4" (101.6mm) outside diameter
- > 1/4-20 mounting stud



Square Base Black Model 861
Square Base Cream Model 861W

- > Square mounting base for solid surfaces, 2.5" x 2.5" (63.5mm x 63.5mm), with four 0.219" (5.56mm) holes on 2.0" (50.8mm) x 2.0" (50.8mm) layout
- > 1/4-20 mounting stud



T-Bar Clip Black Model 863
T-Bar Clip Cream Model 863W

- > T-Bar Clip measure 1.06" x 1.75" (26.9mm x 44.5mm)
- > 1/4-20 mounting stud



Corner/Pipe Base Black Model 865
Corner/Pipe Base Cream Model 865W

- > Perfect for external corners of wall joints or strapped to pipes at least 1.25" (31.8mm) in diameter (straps not included). Face is 0.75" (19.1mm) wide; height is 2.875" (73.0mm)
- > Corner Clamp slots accept max. strap width: 0.75" (19mm); holes dia. 0.2" (5mm)
- > 1/4-20 mounting stud



J-Box Base Black Model 862
J-Box Base Cream Model 862W

- > J-Box Plate, 2.875" wide x 4.56" (73.0mm x 115.8mm) with cable pass thru hole 0.625" (15.9mm) in diameter
- > 1/4-20 mounting stud



Magnetic Base Black Model 864
Magnetic Base Cream Model 864W

- > Magnet holds up to 5 lbs. (2.3kg) in a vertical pull. Base is 2.75" (69.8mm) in diameter and 0.385" (9.8mm) thick
- > 1/4-20 mounting stud

2. Select a Shaft

Choose one of our two shaft styles...
Fixed length or telescoping!



3" (76.2mm) Black Model 856-03

3" (76.2mm) Cream Model 856-03W

> Solid machined aluminum alloy Shafts, 0.875" (22.2mm) in diameter

> 1/4-20 mounting stud

6" (152.4mm) Black Model 856-06

6" (152.4mm) Cream Model 856-06W

> Solid machined aluminum alloy Shafts, 0.875" (22.2mm) in diameter

> 1/4-20 mounting stud

Telescoping Black Model 856T

> Telescoping Shaft extends from 6.75" (171.4mm) to 11" (279.4mm)

> Shaft locks tightly and is indexed to prevent rotation

> 1/4-20 mounting stud

3. Select a Knuckle

Add a Knuckle to Tilt, Turn & Rotate
your CCTV Camera in any direction!



Adj. Knuckle Black Model 851-00

Adj. Knuckle Cream Model 851-00W

> Quality manufactured and fully adjustable: 210° Tilt, 360° Turn & 360° Rotation

> Knob and tamper-resistant set-screw adjusting options included

> Overall knuckle height approximately 2.5" (63.5mm)

> 1/4-20 mounting stud with lockring



*Includes knob and
set-screw with hex key*

A close-up, low-angle shot of the back of a television. The focus is on the mounting area, showing a black plastic mounting bracket with a ball joint. The TV's casing has a textured, ribbed pattern. The background is a soft, out-of-focus gradient of light brown and beige.

Audio/Video Mounts

> Innovative Holding Solutions™

Tilt, Turn & Rotate

PanaVise's "Tilt, Turn & Rotate" technology has been applied to our audio/video mount line and allows you to position speakers or flat panel screens smoothly through 3-planes of motion.

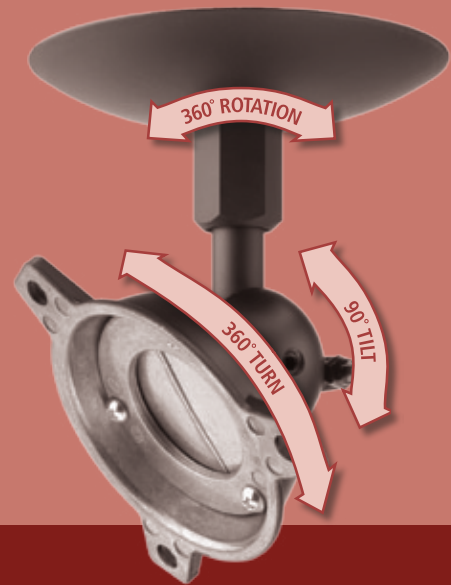

Home Theater

PanaVise Speaker Mounts provide a wide range of mounting solutions for home theater installations. Whether mounting small satellite speakers, center channel, or wall speakers, PanaVise has the right size mount for any size speaker.



Seamless Integration

The versatile adjusting options found on all PanaVise Speaker Mounts allow exact speaker positioning and are the "unseen stars" in any professional installation.



Commercial Applications

Heavy-duty specs require heavy-duty Speaker Mounts. Our 40 lb. Speakers Mounts are perfect for installations in clubs, auditoriums, convention centers, assembly halls, etc.



Flat Screen Revolution

The popularity of flat screen displays is a golden opportunity for professional retrofit installations. PanaVise Flat Screen Mounts are trouble-free and deliver perfect screen positioning.

NEXT >>>

Small Speaker Mounts

PanaVise Speaker Mounts are the convenient, reliable solution for your speaker mounting needs. Once the adjusting points are tightened, the internal mechanism prevents slippage and bracket rattle. PanaVise Speaker Mounts are perfect for home theater, bedroom, den, family room or commercial installations and will provide a lifetime of trouble free service!

8 lb. Stud Mounts Models 105108...

The perfect choice for pre-threaded speakers weighing up to 8 lbs. (3.6kg)!



8 lb. Stud Mounts Black Model 105108B
8 lb. Stud Mounts White Model 105108W

- > Especially recommended for smaller satellite speakers
- > One adjusting point offers a full range of motion: 210° Tilt, 360° Turn & 360° Rotation
- > Two speaker mounting studs supplied: 1/4-20 and 10-32 thread
- > 16-gauge steel surface mounting plate [2" x 3" (50.8mm x 76.2mm)] has two slotted holes and an extra hole for routing speaker wire up to 8mm thick
- > Nylon safety strap and mounting hardware included
- > **Overall length:** 3.625" (92.1mm)

8 lb. Speaker Mounts Models 100106...

The fully adjustable mounting choice for speakers weighing up to 8 lbs. (3.6kg)!



8 lb. Speaker Mount Black Model 100106B
8 lb. Speaker Mount White Model 100106W

- > Double-knuckle design for twice the adjustability
- > Two adjusting points offer a full range of motion: 210° Tilt, 360° Turn & 360° Rotation
- > 16-gauge steel surface mounting plate [2" x 3" (50.8mm x 76.2mm)] includes an extra hole for routing speaker wire up to 8mm thick
- > Speaker mounting plate [2" x 3" (50.8mm x 76.2mm)] includes four round holes and two slotted holes that align with mounting holes on many popular speakers
- > Nylon safety strap and mounting hardware included
- > **Overall length:** 6.25" (158.8mm)

Whether your next installation calls for shelf, wall, or ceiling mounting, PanaVise Speaker Mounts provide a full range of motion for precise speaker aiming. For living rooms, conference rooms, dens or offices — make sure you use versatile PanaVise Speaker Mounts!

20 lb. Speaker Mounts Models 110120...

The fully adjustable mounting choice for speakers weighing up to 20 lbs. (9.1kg)!



20 lb. Speaker Mount Black Model 110120B
20 lb. Speaker Mount White Model 110120W

- > Double knuckle design for twice the adjustability
- > Two adjusting points offer a full range of motion: 210° Tilt, 360° Turn & 360° Rotation
- > Cast aluminum surface mounting plates include an extra hole for routing speaker wire up to 8mm thick
- > Plastic coated, steel safety cable and mounting hardware included
- > Mounting plates are 2.25" x 3.25" (57.1mm x 82.5mm)
- > **Overall length: 7" (177.8mm)**

Mount & Point Speakers Exactly Where You Want Them...

Wall Mounting

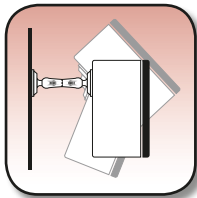

Back of Speaker

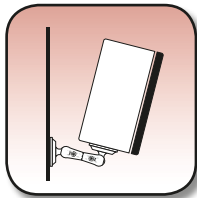

Bottom of Speaker

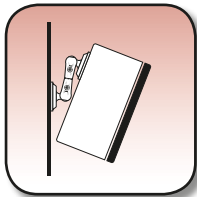

Close Surface Mounting

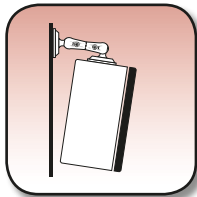

Top of Speaker

Ceiling Mounting

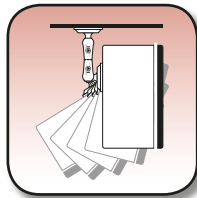

Back of Speaker

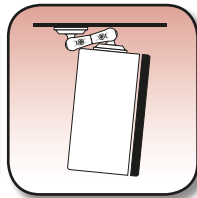

Close Surface Mounting

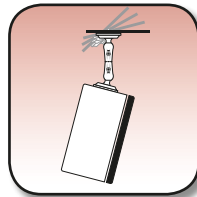

Top of Speaker on Slope

Floor Mounting

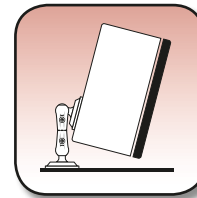

Back of Speaker

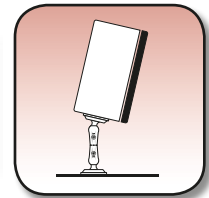

Bottom of Speaker

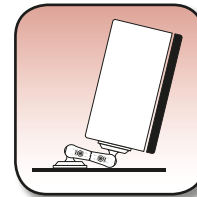

Close Surface Mounting

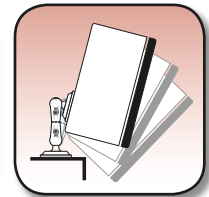

Back of Speaker Over Edge

You might consider adding...



ClipCaddy Holder Model 777

Keep all of your remotes organized and easy to find! Mounts to any smooth surface using double-sided mounting tape. Two buttons are included to convert anything to button back holding.

Large Speaker Mounts

Our unique Speaker Mount line also includes heavy-duty mounts for speakers weighing up to 40 lbs. (18.2kg). You get full PanaVise adjustability and reliability, plus added convenience — **these mounts allow one person to handle the installation!** Recommended for commercial installations such as auditoriums, theaters, restaurants and clubs.

40 lb. Short Drop Ceiling Mount Models 120140...

The versatile, commercial choice for nearly flush installs for speakers weighing up to 40 lbs. (9.1kg)!



40 lb. Short Drop Ceiling Mount Black Model 120140B
40 lb. Short Drop Ceiling Mount White Model 120140W

- > Easy "one person" installation with our unique hanging system
- > Overall length from ceiling bracket to bottom of adjusting base only 6" (152.4mm)
- > Ceiling bracket is 4" (101.6mm) in diameter with four mounting holes on a 2.6" (67mm) bolt circle
- > Includes matching bracket cover [5" (127mm) diameter] for a professional finish
- > Steel shaft is 0.625" (15.9mm) in diameter
- > Adjusting base has three feet with holes on a 4.3125" (109.5mm) bolt circle
- > Base provides 90° Tilt, 360° Turn & 360° Rotation for precise aiming
- > Base locks firmly into place for worry-free installations
- > Plastic coated, steel safety cable and mounting hardware included

40 lb. Long Drop Ceiling Mount Models 120240...

Perfect when a longer drop, and plenty of adjustability, is required for speakers weighing up to 40 lbs. (7.2kg)!

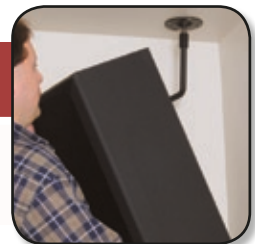

40 lb. Long Drop Ceiling Mount Black Model 120240B
40 lb. Long Drop Ceiling Mount White Model 120240W

- > Easy "one person" installation with our unique hanging system
- > Steel shaft is 0.625" (15.9mm) in diameter with 60° bend, 9.375" (238.1mm) drop and 5.375" (136.5mm) offset
- > Ceiling bracket is 4" (101.6mm) in diameter with four mounting holes on a 2.6" (67mm) bolt circle
- > Includes matching bracket cover [5" (127mm) diameter] for a professional finish
- > Adjusting base has three feet with holes on a 4.3125" (109.5mm) bolt circle
- > Base provides 90° Tilt, 360° Turn & 360° Rotation for precise aiming
- > Base locks firmly into place for worry-free installations
- > Plastic coated, steel safety cable and mounting hardware included

*Patents Pending in the USA and overseas.

40 lb. Wall Mount Models 120340...

A solid installation with plenty of aiming power for speakers weighing up to 40 lbs. (7.2kg)!



40 lb. Wall Mount Black Model 120340B

40 lb. Wall Mount White Model 120340W

- > Easy "one person" installation with our unique hanging system
- > Overall length from top of wall bracket to center of adjusting base 9.375" (238.1mm)
- > 60° bend in steel shaft places center of adjusting base approx. 5.375" (136.5mm) from wall
- > Shaft is 0.625" (15.9mm) in diameter
- > Wall bracket is 2" x 5.25" (50.8mm x 133.3mm) with two mounting holes 3.75" (95.3 mm) apart
- > Matching cover plate is 2.125" wide x 5.375" high x 2.5" deep (54mm x 136.5mm x 63.5mm)
- > Adjusting base has three feet with holes on a 4.3125" (109.5mm) bolt circle
- > Base provides 90° Tilt, 360° Turn & 360° Rotation for precise aiming
- > Base locks firmly into place for worry-free installations
- > Plastic coated, steel safety cable and mounting hardware included

How to Use...

Proper installation can be accomplished by one person, although care is needed when working with heavy speakers. Select the point of installation, ensuring the stud, ceiling or wall will hold the weight of the speaker. Choose the position of the mounting base and attach to the speaker. Insert the shaft and tighten. Simply hang the speaker in the ceiling or wall bracket as shown. It's that easy!



*Patents Pending in the USA and overseas.

Flat Screen Mounts

Flat screen monitors are a golden opportunity for installation professionals when hotels, restaurants, bars and public facilities upgrade to newer screens. PanaVise presents a superb line of flat screen mounts with exceptional adjustability and durability that will satisfy the most demanding customers.

Wall Mount with VESA Plate Models 120340B...

Fully adjustable for precise screen positioning!



Wall Mount 75mm Plate
Wall Mount 100mm Plate

Black Model 120340B-75MM
Black Model 120340B-100MM

- > Easy "one person" installation with our unique hanging system
- > Holds flat panel screens weighing up to 40 lbs. (18.2kg)
- > Overall length from top of wall bracket to center of adjusting base 9.1" (231.1mm)
- > Shaft is 0.625" (15.9mm) in diameter. Wall bracket is 2" x 5.25" (50.8 mm x 133.3mm) with two mounting holes 3.75" (95.3mm) apart
Matching cover plate is 2.125" wide x 5.375" high x 2.5" deep (5mm x 136.5mm x 63.5mm)
- > 60° bend in steel shaft places center of adjusting base approx. 5.375" (136.5mm) from wall
- > VESA compatible mounting plate. Includes hardware mounting kit

Flat Screen/Camera Mount Models 336-FPMC...

The perfect retail mounting solution for video displays showing security images!



Screen/Camera Mount 75mm **Black** Model 336-FPMC-75
Screen/Camera Mount 100mm **Black** Model 336-FPMC-100

- > Exclusive design for specialty retail installations
- > Fully adjustable at the screen, 90° Tilt, 360° Turn & 360° Rotation
- > Fully adjustable at the camera, 210° Tilt, 360° Turn & 360° Rotation
- > VESA compatible mounting plate
- > Threaded for use with 3/4" (19.1mm) rigid conduit or NPT pipe
- > Drop length determined by installer
- > Includes mounting kit and instructions
- > Holds flat panel screens weighing up to 40 lbs. (18.2kg)

*Patents Pending in the USA and overseas.

The explosion in flat screen monitors for use on desks and at work stations provides the perfect opportunity for this combination mounting system! By mixing and matching the components shown on this page, you can create the perfect mounting solution for smaller flat screens!

Flat Screen Work Station Mount Models 336...

Full monitor adjustability for your desk or work station!

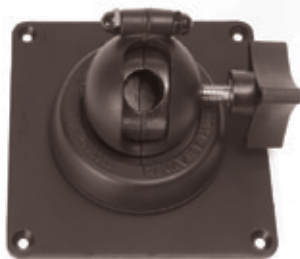
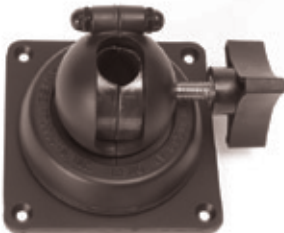
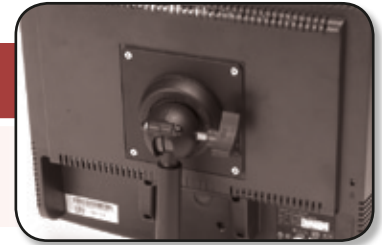

Work Station Mount 75mm Black Model 336-V75
Work Station Mount 100mm Black Model 336-V100

- > Fully adjustability — 90° Tilt, 360° Turn & 360° Rotation — for precise screen positioning
- > Includes knob or set-screw adjusting options (not pictured)
- > Accepts any 5/8" (15.9mm) diameter shaft
- > Recommended for smaller flat panel screens although maximum weight capacity is up to 40 lbs. (18.2kg)
- > VESA compatible mounting plate
- > Stands sold separately (see below)

Work Station Mount Stand Models 960...

Rugged stands for use with flat screen work station mounts!



Mount Stand, 6" (127mm) Black Model 960-06
Mount Stand, 9" (203.2mm) Black Model 960-09

- > Available in two rise heights
- > Base plate measures 4.25" x 4.25" (108mm x 108mm)
- > Base is pre-drilled with four 0.328" (8.33mm) corner holes
- > Steel shaft is 1" (25.4mm) in diameter at the base and 5/8" (15.9mm) at the top
- > Recommended for use with 336 series Work Station Mounts (sold separately, see above)

*Patents Pending in the USA and overseas.



Mobile Electronics Mounts

> Innovative Holding Solutions™

Tilt, Turn & Rotate

PanaVise offers the most complete line of Mobile Electronics Mounts in the industry. From satellite radios, to GPS units, to cell phones, you'll find the perfect mounting solution for your next installation.

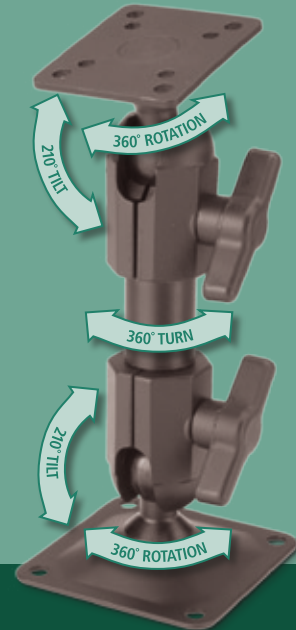

Fully Adjustable

PanaVise mounts bring full adjustability and convenience to heavy-duty installations such as mobile two-way radios and mobile data terminals.

AMPS-Compatible

An industry-wide mounting standard since the 1980s, the rectangular AMPS-compatible pattern measures 30mm x 38mm (1.181" x 1.496") on-center. Hole diameter is 0.18" (4.6mm).



Continual Innovation

PanaVise continues to develop mounts for current generation vehicles and mobile electronics products. Designed, engineered and manufactured to the highest quality standards, PanaVise Mobile Communications Mounts continue to be the industry leaders in performance and ergonomics.

NEXT >>>

Powerful Window Mounts

With the explosion in mobile electronics – especially satellite radios and GPS units — there’s an industry-wide need for a complete line of reliable window mounts. Responding to the needs of our customers, PanaVise designed a powerful line of window mounts with plenty of adjustability. Our 709B and 809 series even passed a 35mph crash test!

Larger Window Mounts Models 809...

Powerful suction pad securely adheres larger electronics to any flat glass surface!



All Model 809 series Mounts Feature:

- > Powerful suction pad attaches to any smooth, flat, non-porous surface including windshields and side windows
- > Easily move electronics from vehicle-to-vehicle or remove for security
- > Full range of motion at the head plate (knob adjustment): 210° Tilt, 360° Turn & 360° Rotation
- > Ratcheted arm has 140° motion; knob locks arm into place
- > Suction pad is 3.4" (86.4mm) in diameter with quick release tab
- > Recommended for electronics weighing up to 3.0 lbs. (1.4kg)
- > Overall length is approximately 5.25" (133.3mm)

CCTV Camera Window Mount

Model 809

- > Perfect for in-vehicle camera systems
- > 1/4-20 mounting stud with locking

Standard AMPS Window Mount

Model 809-AMP

- > For electronics with AMPS-compatible mounting (page 45)

Window Mount w/Electronics Holder Model 809-PG

- > Includes Model 703 PortaGrip adjustable electronics holder (page 51)

Quick Release Window Mount

Model 809-QR

- > Quickly release electronics from mount
- > For electronics with AMPS-compatible mounting (page 45)
- > Includes 675-BT Quick Release (page 50)

T-Bolt Window Mount

Model 809-TS

- > For electronics with T-Slot mounting
- > T-Bolt measures 0.5" x 0.5" (12.7mm x 12.7mm)



Smaller Window Mounts Models 810...

Powerful window mounts for today's smaller electronics!



All Model 810 series Mounts Feature:

- > Powerful suction pad attaches to any smooth, flat, non-porous surface — including windshields and side windows
- > Easily move electronics from vehicle-to-vehicle or remove for security
- > Electronics mounting plate tilts up and down (locks with knob) and features 20° Tilt in all directions
- > Ratchet arm has 140° motion; knob locks arm into place
- > Suction pad is 2.8" (71mm) in diameter
- > Recommended for electronics weighing less than 2.0 lbs. (0.9kg)
- > Quick release suction cup tab

Standard AMPS Window Mount Model 810-AMP

- > For electronics with AMPS-compatible mounting (page 45)

Button-Style Window Mount Model 810-BT2

- > For electronics with button-style mounting

Quick Release Window Mount Model 810-QR

- > Quickly release electronics from mount
- > For electronics with AMPS-compatible mounting (page 45)
- > Includes 675-BT Quick Release (page 50)

WindowGrip Deluxe Model 709B

Telescoping window mount — perfect for long dashboards!



WindowGrip Deluxe Features...

- > Telescoping arm adjusts from 13.25" (336.6mm) to 18" (457.2mm). Locks into position and is indexed to prevent rotation
- > Aircraft grade aluminum alloy shaft
- > Arm has 140° motion; knob locks arm into place
- > Full range of motion at the head plate (knob adjustment): 210° Tilt, 360° Turn & 360° Rotation
- > For electronics with AMPS-compatible mounting (page 45)

Custom Dash Mounts

Custom dash mounts from PanaVise are vehicle-specific and are carefully engineered in our factory in Reno, Nevada. Ergonomically designed, InDash mounts will not interfere with gauges, vents or air bag deployment. Mounts are available for passenger vehicles, SUVs, vans, light & medium duty trucks and semi's — the latest models are always available!

InDash Custom Dash Mounts

For that factory-installed look — InDash is your solution!



InDash Custom Dash Mounts Feature:

- > Custom designed for specific passenger vehicles, SUVs, vans, light & medium duty trucks and semi's
- > An excellent choice for a wide variety of mobile electronics including satellite radios, GPS units, mobile video screens, etc...
- > Made from high grade steel for maximum strength
- > For electronics with AMPS-compatible mounting (page 45)
- > Full range of mounting accessories for the perfection installation (pages 49-51)
- > Complete mounting instructions and screw kit included with every mount
- > Log onto our website www.panavise.com/indash.html for the latest applications listing, updates and part # searches

Universal Dash Mounts

For custom mounting solutions — right in the installation bay!

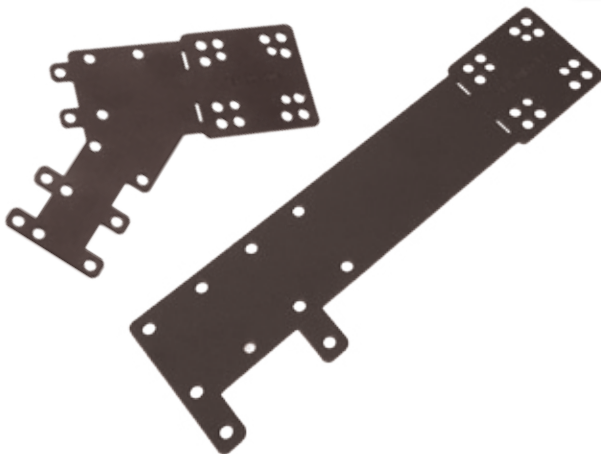

All Universal Dash Mounts Feature:

- > If you're confronted with a rush situation and timing is critical, our Universal Dash Mounts can be cut, bent and installed to fit any vehicle.
- > Includes template and instructions
- > Sturdy 18-gauge steel mount

Angle Universal Mount Model 75-UNI-A

- > 45° angle

Straight Universal Mount Model 75-UNI-B

- > Extra-long 9.125" (231.8mm) bracket

PanaVise provides a wide range of specialty plates and adapters to make every InDash installation the perfect mounting choice. Whether you need a surface moved slightly to the right or left, up or down, or want a little more adjustability, our extensive selection will satisfy the most demanding customer!

InDash Mounting Accessories

The little extras that add even more custom mounting choices!



All InDash Mounting Accessories Feature:

- > AMPS Hole Patterns: use with any AMPS compatible mounting plates and devices (page 45)
- > Allows greater flexibility for installing odd shaped and multiple devices
- > Aluminum alloy Brackets minimize weight and vibration

"Wedgie" Model 762

- > Angles 30° to improve viewing angle on flip-style phones
- > Low profile solution; clean installation; steel construction
- > Can also be used as a wire guide

3" Adjustable Mounting Bracket Model 767-AL03

- > Allows you to shift your device 1/2 AMPS pattern (1.25") up, down, right or left

4" Adjustable Mounting Bracket Model 767-AL04

- > Allows you to shift your device 1 full AMPS pattern (2") up, down, right or left. Makes it possible to mount 2 devices side by side
- > Includes cover plate with studs and nuts for a quick, clean install

5" Adjustable Mounting Bracket Model 767-AL05

- > Allows you to shift your device 1-1/2 AMPS pattern (3") up, down, right or left. Makes it possible to mount 2 devices side by side
- > Includes cover plate with studs and nuts for a quick, clean install

4" Extension Bracket Model 768-AL

- > Allows you to shift your device 1 AMPS pattern (2") and includes studs for a clean looking installation

"Z" Extension Bracket Model 769-AL

- > Allows you to shift your device 1-1/2 AMPS pattern (3") up, down, right or left
- > Includes cover plate with studs and nuts for a quick, clean install

Tipppers Model 685

- > Adds 30 degree tilt in any direction for increased flexibility
- > Four models to choose from (page 51)

Mounting Accessories

Our complete line of mounting accessories brings a new dimension to customer service and satisfaction. Whether you're adding a quick release solution, providing extra adjusting power, or holding mobile electronics gently, yet firmly, this line of accessories expands the installer's options with unprecedented choices.

Adjusting Knuckles Models 651...

Add 210° Tilt, 360° Turn & 360° Rotation to any installation!

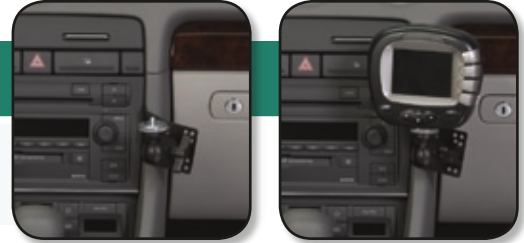

Includes knob and set-screw with hex key

1/4-20 Stud Adjusting Knuckle Model 651-S T-Bolt Adjusting Knuckle Model 651-TS

- > Full adjustability with knob and set-screw options and locking included
- > Overall knuckle height approximately 2.5" (63.5mm)
- > Base drilled and tapped 1/4-20

Quick Release Interface Model 675-BT

A quick change artist for today's mobile electronics!



Quick Release Interface Model 675-BT

- > Base and top are AMPS-compatible (page 45) and provide a quick release interface for a wide variety of electronics including satellite radios and GPS units
- > Quickly remove electronics for security or move them from vehicle-to-vehicle
- > Top firmly attaches to the base with a solid "click"
- > Made of black, high-impact polycarbonate plastic
- > Simply lift the latch to remove the electronics

Satellite Radio Adapter Plate Model 670-A

An easy mounting solution for XM satellite radios!



Satellite Radio Adapter Plate Model 670-A

- > AMPS-compatible adapter plate converts any AMPS-compatible (page 45) mount into an XM-style satellite radio mount!
- > Suitable for any XM satellite radio or electronics with a T-Button mounting system
- > Compatible with all similar systems
- > Made of durable glass fiber-reinforced composite plastic

Tipplers Models 685...

Add user adjustability to any installation... quickly & easily!



AMPS Tipper Model 685-PM

- > Users can easily position and reposition their electronics (30° Tilt & 360° Rotation)
- > Smooth adjusting action holds electronics firmly in place
- > Extends approximately 1.5" (38.1mm) from face of mount
- > Body made of black, high-impact polycarbonate plastic with aluminum ball & head plate
- > Interfaces between AMPS-compatible mounting plate and AMPS-compatible electronics

Offset Tipper Model 685-OS

- > Interfaces between AMPS-compatible mounting plate and AMPS-compatible electronics
- > Mounting plate is offset 0.75" (19.1mm) from center point

T-Bolt Tipper Model 685-TS

- > T-Bolt measures 0.5" x 0.5" (12.7mm x 12.7mm)
- > Interfaces between AMPS-compatible mounting plate (page 45) and T-Slot

1/4-20 Stud Tipper Model 685-S

- > Interfaces between AMPS-compatible mounting plate (page 45) and 1/4-20 thread

PortaGrip 2000 Holders Models 702 & 703

The only portable holders fully with adjustable width & length!



Flat Base PortaGrip 2000 Model 702

Cup Base PortaGrip 2000 Model 703

- > Width adjusts to accommodate electronics from 1.16" (29.5mm) to 2.5" (63.5mm)
- > Vertical adjustment of 1.4" (35.6mm) allows the user to adjust holder to avoid side buttons, ports and knobs
- > No tools required to adjust the jaws; jaws open with a quick release button
- > Sure grip soft jaws hold firmly, but gently — won't scratch
- > Attaches easily to any AMPS-compatible mount (page 45) (mount required for installation; sold separately)

You might consider adding...



ClipCaddy Holder Model 777

Holds belt clips up to 1.2" (30.5mm) wide. Mounts to any smooth surface using double-sided mounting tape. Two buttons are included to convert anything to button back holding.

Pedestal Mounts

A variety of pedestal mount configurations deliver custom mounting solutions with off-the-shelf convenience. The small foot size is especially recommended for under the dash installations or wherever space is at a premium. Interchangeable shafts are a convenient accessory that deliver the ability to adjust a mounting height in seconds. PanaVise pedestal mounts: the first choice for professionals.

Slimline Pedestal Mounts Models 727...

The world's first choice for reliable, quality pedestal mounts!

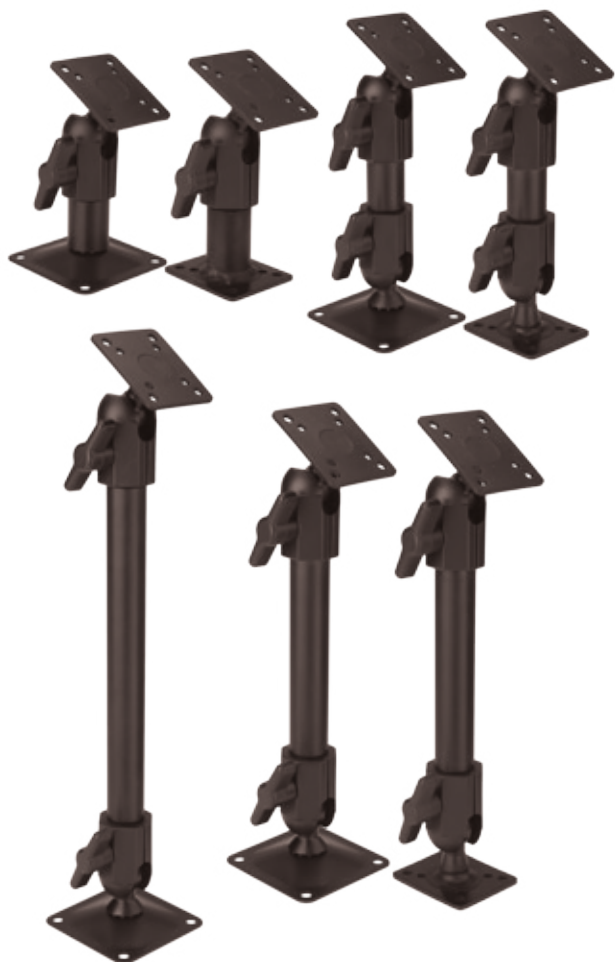

- Slimline 4" (101.6mm) Standard Foot** Model 727-04
- Slimline 4" (101.6mm) Small Foot** Model 727-04SF
- Slimline 6" (152.4mm) Standard Foot** Model 727-06
- Slimline 6" (152.4mm) Small Foot** Model 727-06SF
- Slimline 9" (228.6mm) Standard Foot** Model 727-09
- Slimline 9" (228.6mm) Small Foot** Model 727-09SF
- Slimline 12" (304.8mm) Standard Foot** Model 727-12

- > 210° Tilt, 360° Turn & 360° Rotation at both ends
- > Aluminum, zinc and steel construction
- > AMPS-compatible mounting pattern (page 45)
- > Concave Standard Foot evenly distributes the mounting load, accommodates slightly irregular surfaces, will not crack, and measures 2.5 x 2.5" (63.5mm x 63.5mm)
- > Small Foot measures 1.625" x 2" (41.3mm x 50.8mm)

Note: pedestal mount measurements refer to the overall rise height, not to the length of the shaft.



Includes knobs and set-screws with hex key



You might consider adding...

Interchangeable Shafts Models 730-06, 730-09, 730-12

Replacement steel shafts allow an installer to quickly change the rise height of a pedestal mount to 6" (152.4mm), 9" (228.6mm) or 12" (304.8mm). Compatible with all 727 series Pedestal Mounts (except -04).

Note: shaft descriptions indicate the final mount's overall rise height (when used with the head and foot assemblies), and not to the length of the shaft.

Pedestal mounts from PanaVise are the industry standard! A wide range of styles and overall installation heights deliver solid, trouble-free performance. First introduced in 1988, our pedestal mounts are characterized by superior engineering, ease of use and installation, and exceptional adjustability.

T-Bolt Pedestal Models 627...

The perfect pedestal for T-Slot components!



T-Bolt Pedestal 6" (152.4mm) Standard Foot Model 627-06
T-Bolt Pedestal 6" (152.4mm) Small Foot Model 627-06SF

- > T-Bolt measures 0.5" x 0.5" (12.7mm x 12.7mm)
- > 210° Tilt, 360° Turn and 360° Rotation at both ends
- > Aluminum, zinc and steel construction
- > Concave Standard Foot evenly distributes the mounting load, accommodates slightly irregular surfaces, will not crack, and measures 2.5 x 2.5" (63.5mm x 63.5mm)
- > Small Foot measures 1.625" x 2" (41.3mm x 50.8mm)



Includes knobs and set-screws with hex key

Slimline 2000 Pedestal Mounts Models 717...

The value priced pedestal mount!



Slimline 2000 6" (152.4mm) Model 717-06
Slimline 2000 9" (228.6mm) Model 717-09

- > 210° Tilt, 360° Turn and 360° Rotation at both ends
- > Head plate is molded of durable glass fiber-reinforced composite plastic
- > Aluminum alloy shaft
- > Housings at the head and foot incorporate a serrated contact design that increases gripping power at the adjusting points
- > AMPS-compatible mounting pattern (page 45)
- > Foot is molded of durable long glass fiber-reinforced composite plastic
- > Concave foot design evenly distributes the mounting load for maximum stability and eliminates "carpet float"
- > Foot measures 2.5" x 2.5" (63.5mm x 63.5mm)



Includes knobs and set-screws with hex key

Radio & Communications Mounts

These heavy-duty communications mounts first appeared in the mid-1980s and have been going strong ever since! Based on the famous "split-ball" incorporated into our work holding vises, these mounts are perfect for heavier electronics and active work situations — built tough with plenty of options and adjustability.

Universal Radio Mount Models 950 & 951

The preferred choice for in-vehicle two-way radios!



- Radio Mount, 0-90° tilt, 6" (152.4mm) rise Model 950-06
- Radio Mount, 0-90° tilt, 9" (228.6mm) rise Model 950-09
- Radio Mount, 45-45° tilt, 6" (152.4mm) rise Model 951-06
- Radio Mount, 45-45° tilt, 9" (228.6mm) rise Model 951-09

- > Universal slotted head plate measures 7.5" x 2.5" (190.5mm x 63.5mm) with 0.25" side slots (slot length varies)
- > Maximum holding power: up to 10 lbs. (4.5kg)
- > Base footprint has four 0.219" (5.56mm) holes on a 4.23" (107.5mm) circle
- > Includes knob and set-screw adjusting options



Includes knob and set-screw with hex key

Communications Mounts Models 320 & 322

Big and bold, when you need maximum hold!



- Mount w/Straight Shaft, 6" (152.4mm) rise Model 320
- Mount w/Adjustable Head, 6" (152.4mm) rise Model 322

- > AMPS-compatible mounting plate (page 45)
- > 5/8" (15.9mm) shafts are easily removed and are interchangeable
- > Base includes knob or tamper-resistant set-screw adjusting options
- > Base adjusting can be from either side of ball housing
- > Base footprint has four 0.219" (5.56mm) on a 4.23" (107.5mm) circle
- > Head on 322 series features 210° Tilt, 360° Turn & 360° Rotation and includes knob and set-screw adjusting options



322 Head includes knob and set-screw with hex key



Bases include knob and set-screw with hex key

Custom Component System

PanaVise provides installers with the ability to build custom mounting solutions with off the shelf convenience! These components feature individual shafts and our heavy-duty bases, perfect for fleet operations and tough work environments. Special arrangements can be made to provide custom rises or hole patterns (minimum quantities apply).

1. Select a Base...

Heavy duty bases take on the toughest challenges!



Includes knob and set-screw with hex key

Standard Base, 90° tilt Model 328
Standard Base, 45-45° tilt Model 329

- > Model 328: 90° Tilt, 360° Turn & 360° Rotation
- > Model 329: 45-45° Tilt over center with 360° Turn & 360° Rotation
- > Footprint has four 0.219" (5.6mm) holes on a 4.23" (107.5mm) circle
- > Includes knob or set-screw adjusting options. Knob or set-screw may be used from either the right or left-side of the housing
- > Accepts any 5/8" (15.9mm) diameter shaft

2. Select a Shaft...

A variety of rise selections — choose the perfect solution!



Includes knob and set-screw with hex key

Straight Shaft, 6" (152.4mm) rise Model 326-06
Straight Shaft, 12" (304.8mm) rise Model 326-12

- > AMPS-compatible mounting plate (page 45)
- > 5/8" (15.9mm) shafts are easily removed and interchangeable

Deluxe Shaft, 6" (152.4mm) rise Model 327-06
Deluxe Shaft, 12" (304.8mm) rise Model 327-12

- > AMPS-compatible mounting plate (page 45)
- > Features 210° Tilt, 360° Turn & 360° Rotation for added adjustability
- > 5/8" (15.9mm) diameter shafts are easily removed and interchangeable

Note: shaft descriptions indicate the final mount's overall rise height (when used with the head and foot assemblies), and not to the length of the shaft.

Communications Mount Component Compatibility Chart

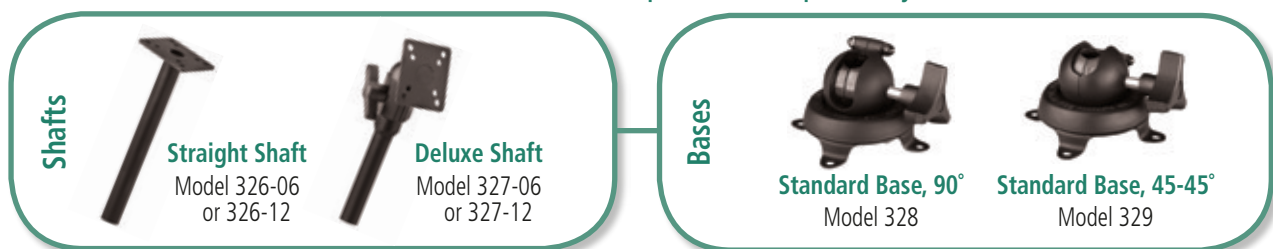

Premier MDT Component System

The ability to provide custom mountings solutions for nearly every application means that the ability to mix and match components is the key to our success. The MDT configurations on this page couple extreme adjustability with extreme reliability into one outstanding product!

Premier MDT Component System

Full adjustability at both ends with plenty of options!



Premier MDT Component System Features:

- > Mix and match heads and base plates as needed
- > Steel and zinc construction for heavy-duty work environments
- > Fully adjustable at both ends
- > Components sold separately

MDT Component Compatibility Chart

MDT Heads



MDT Head 90° Tilt
Model 336MDT



MDT Head/Base 90° Tilt w/Mount Holes
Model 305MDT

MDT Shafts



Premier MDT Shaft, 6"/>"
Model 909-06 or 909-09



Solo MDT Shaft, 6"/>"
Model 979-06 or 979-09

MDT Bases



Heavy Duty Base
Model 400MDT



MDT Head/Base 90°
Model 305MDT



Std. Base 90°
Model 328



Std. Base 45-45°
Model 329



Knob and set-screw with hex key adjusting options are included with Models 305MDT, 328, 329 and 336MDT. Ball housings on these Models are drilled and tapped so that a knob or set-screw can be used in either the right or left hand side of the housing (but not both).

1. Select a Base & Head

Choose one of our five unique bases and three unique heads for mounting to a variety of components.



MDT Head, 90° tilt w/mounting holes MDT Head/Base, 90° tilt

Model 305MDT
Model 336MDT

- > Model 305MDT: Head/Base with three mounting holes on 4.3125" (109.5mm) bolt circle and knob adjustment
- > Model 336MDT: Head with knob adjustment
- > Fully adjustable: 90° Tilt, 360° Turn & 360° Rotation under the terminal
- > Accepts any 5/8" (15.9mm) diameter shaft

Heavy Duty Base

Model 400MDT

- > Recommended for heavy terminals and electronics
- > 90° Tilt, 360° Turn & 360° Rotation
- > Square base measures 4.094" x 4.094" (104mm x 104mm)
- > Pre-drilled with four 0.219" (5.6mm) holes
- > Accepts any 1" (25.4mm) diameter shaft

Standard Base, 90° tilt

Model 328

Standard Base, 45-45° tilt

Model 329

- > Model 328: 90° Tilt, 360° Turn & 360° Rotation
- > Model 329: 45-45° Tilt over center with 360° Turn & 360° Rotation
- > Base footprint has four 0.219" (5.6mm) on a 4.23" (107.5mm) circle
- > Accepts any 5/8" (15.9mm) diameter shaft

2. Select a Shaft

Choose one of our two shaft styles and lengths.

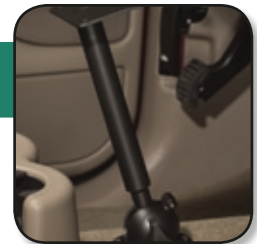

Premier MDT Shaft, 6" (152.4mm) rise Premier MDT Shaft, 9" (228.6mm) rise

Model 909-06
Model 909-09

- > Model 909-06: Creates 6" rise height
- > Model 909-09: Creates 9" rise height
- > 1" (25.4mm) diameter at base end, 5/8" (15.9mm) diameter at head end

Solo MDT Shaft, 6" (152.4mm) rise Solo MDT Shaft, 9" (152.4mm) rise

Model 979-06
Model 979-09

- > Model 979-06: Creates 6" rise height
- > Model 979-09: Creates 9" rise height
- > 5/8" (15.9mm) diameter at both ends

Note: shaft descriptions indicate the final mount's overall rise height (when used with the head and foot assemblies), and not to the length of the shaft.

Mobile Data Terminal Mounts

PanaVise Mobile Data Terminal (MDT) mounts are designed to accommodate a wide range of messaging and mobile data terminals. Our mounts offer a full range of positioning options and are perfect for fleet operations where different drivers use the same vehicle. Special arrangement can be made to provide custom rises or hole patterns.

Express MDT Components

Simple, easy-to-install system for mobile data terminals!



Express MDT Components Feature:

- > Mix and match heads and base plates as needed (components sold separately)
- > Steel and zinc construction for heavy-duty work environments
- > Fully adjustable under the terminal

MDT Head, 90° tilt w/mounting holes Model 305MDT
MDT Head/Base, 90° tilt Model 336MDT

- > Model 305MDT: Head/Base with three mounting holes on 4.3125" (109.5mm) bolt circle and knob adjustment
- > Model 336MDT: Head with knob adjustment
- > Fully adjustable: 90° Tilt, 360° Turn & 360° Rotation under the terminal
- > Accepts any 5/8" (15.9mm) diameter shaft



Includes knob and set-screw with hex key

Flat Base Plate, 6" (152.4mm) rise Model 960-06
Flat Base Plate, 9" (152.4mm) rise Model 960-09

- > Steel base measures 4.25" (108mm) x 4.25" (108mm) and is pre-drilled with four 0.328 (8.3mm) mounting holes
- > Compatible with 305MDT and 336MDT Heads

Note: part number indicates overall mount rise height when used with a head, not to the length of the shaft.

Flex Mounts

PanaVise Flex Mounts have double wound shafts for maximum rigidity and continuous reliability. The point: they stay where you put them! Carefully engineered for heavy-duty use, the shafts won't come loose and can be positioned and re-positioned thousands of times. A variety of options are available for the professional installer.

Stay-Put Flex Mounts Models 782...

Our basic flex with some special features!

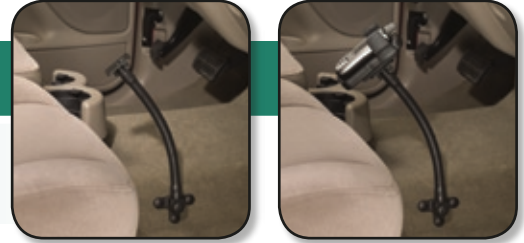

- Stay-Put Flex Mount, 6" (152.4mm) overall length** Model 782-06
- Stay-Put Flex Mount, 8" (203.2mm) overall length** Model 782-08
- Stay-Put Flex Mount, 10" (254.0mm) overall length** Model 782-10
- Stay-Put Flex Mount, 12" (304.8mm) overall length** Model 782-12

- > Patented "pinch design" prevents the flex shaft from coming loose from the base or the mounting plate
- > Double wound shaft, vinyl coated for heavy-duty protection
- > Base can be mounted vertically or horizontally; the shaft easily screws into either configuration
- > AMPS-compatible mounting plate (page 45)
- > Screw caps included for a finished look

Note: length describes overall mount length and not to the length of the shaft

UniFlex Mount Models 797...

Need even more adjustability? The PanaVise UniFlex has it!

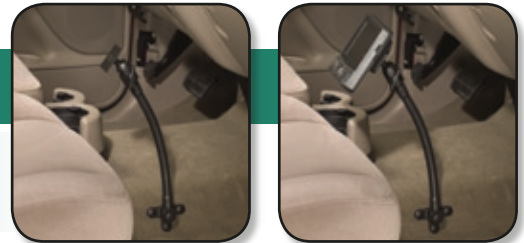

- UniFlex Mount, 10" (254.0mm) overall length** Model 797-10
- UniFlex Mount, 12" (304.8mm) overall length** Model 797-12
- UniFlex Mount, 14" (355.6mm) overall length** Model 797-14

- > Patented "pinch design" prevents the flex shaft from coming loose from the base or the mounting plate
- > We've added an adjusting point under the AMPS-compatible mounting plate (page 45) with 210° Tilt, 360° Turn & 360° Rotation
- > Knob and set-screw adjusting options included
- > Double wound shaft, vinyl coated for heavy-duty protection
- > Base can be mounted vertically or horizontally; the shaft easily screws into either configuration
- > Screw caps included for a finished look

Note: length describes overall mount length and not to the length of the shaft



Includes knob and set-screw with hex key

Index: BY MODEL

Model	Product Name	Page	Model	Product Name	Page
201	PV Jr. Vise	6	651-S	1/4-20 Stud Adjusting Knuckle	50
203	PV Jr. Head	10	651-TS	T-Bolt Adjusting Knuckle	50
204	Neoprene Jaw Pads	22	670-A	T-Style Adapter Plate	50
209	Vacuum Base PV Jr.	6	675-BT	Quick Release Interface	50
300	Standard Base	13	685 series	Tipppers	51
301	Standard PanaVise	7	702, 703	PortaGrip 2000 Mobile Electronics Holders	51
303	Standard Head	10	709B	WindowGrip Deluxe	47
304	Low-Profile Head	11	717	Slimline 2000 Pedestal Mount	53
305	Low-Profile Base	13	727	Slimline Pedestal Mount	52
305MDT	MDT Head/Base w/mounting holes	57	730	Slimline Interchangeable Shaft	52
308	Weighted Base Mount	14	75-UNI-A	Angle Universal Dash Mount	48
310	Surface Plate Base Mount	14	75-UNI-B	Straight Universal Dash Mount	48
311	Bench Clamp Base Mount	14	762	Wedgie	49
312	Parts Tray Base Mount	15	767 series	Adjustable Aluminum Extension Brackets	49
315	Circuit Board Holder	12, 16	768-AL	4" Aluminum Extension Bracket	49
316	Circuit Board Arms	17	769-AL	"Z" Aluminum Extension Bracket	49
318	Circuit Board Cross Bars	17	777	ClipCaddy	39, 51
319	Replacement Knobs, Circuit Board Holder	17	782	Stay-Put Flex Mount	59
320	Standard Phone Mount	54	797	UniFlex Flex Mount	59
322	Deluxe Phone Mount	54	809	CCTV Camera Window Mount	32
324	Electronic Work Center	16	809 series	Mobile Electronics Window Mounts	46
326	Straight Shaft	55	810 series	Mobile Electronics Window Mounts	47
327	Deluxe Shaft	55	817	Flex Mount	32
328	Standard Base, 90° tilt	55	817-A	Flex Adapter	32
329	Standard Base, 45/45° tilt	55	827	Deluxe CCTV Camera Mount	30
333	Rapid Assembly Circuit Board Holder	17	845-246	Deluxe Micro Mount	27
335	Magnetic Base Mount	15	846	Standard Micro Mount	26
336-FPMC	Flat Screen/Camera Mount	42	846L	Angle Micro Mount	27
336-V75	Work Station Mount	43	847	Micro Conduit Mount	33
336-V100	Work Station Mount	43	848-03NP	Micro Conduit Mount Ext. Shaft	33
336MDT	MDT Head/Base	57	848-06	Pass Thru Micro Mount	26
337	Fixturing Head	12	849-06	Pass Thru Standard Mount	30
343	Nylon Jaws	22	851	Adjusting Knuckle	35
344	Grooved Nylon Jaws	22	854	Standard Conduit Mount	33
346	Neoprene Jaw Pads	22	856	Shaft	35
350	Multi-Purpose Work Center	8	856-03NP	Conduit Mount Extension Shaft	33
352	Teflon® High Heat Jaws	22	856T	Telescoping Shaft	33
353	Plated Steel Jaws	22	860	Tri-Foot Base	34
354	Brass Jaws	22	861	Square Base	34
358	Wire Manager	23	862	J-Box Plate	34
366	Wide Opening Head	11	863	T-Bar Drop Ceiling Rail Clip	34
371	Solder Station	23	864	Magnetic Base	34
376	Extra-Wide Opening Head	11	865	Corner/Pipe Mount	34
380	Vacuum Base	13	870	CCTV Camera Tree	29
380-RK	Vacuum Repair Kit	23	883	Dual Option Mount	31
381	Vacuum Base PanaVise	7	883T	Dual Option Telescoping Mount	31
385	Micrometer Holder	12	897	J-Box Mount	29
391	Micrometer Stand	12	898-06	Pass Thru J-Box Micro Mount	28
396	Wide Opening Head PanaVise	8	899-06	Pass Thru J-Box Standard Mount	28
400	Heavy Duty Base	21	909	Premier MDT Shaft	56
400MDT	Heavy Duty MDT Base	57	950, 951	Universal Radio Mount	54
437	Heavy Duty Fixturing Head	21	960	Flat Base Plate	43, 58
502	PanaPress Arbor Press	18	979	Solo MDT Shaft	57
506	IDC Bench Assembly Press Retrofit Kit	18	100106	8 lb. Speaker Mount	38
507	Flat Ribbon Cable Cutter	20	105108	8 lb. Stud Mount	38
510-513	IDC Base Plates	20	110120	20 lb. Speaker Mount	39
530	Replacement Blades, Cable Cutter	20	120140	40 lb. Short Drop Ceiling Mount	40
532	Replacement Guide Arm	19	120240	40 lb. Long Drop Ceiling Mount	40
561	Crimp Press Retrofit Kit	19	120340	40 lb. Wall Mount	41
570	Posi-Stop	19	120340B	Flat Screen Wall Mount	42
627	T-Bolt Pedestal Mounts	53			

Index: BY NAME

Product Name	Section	Model	Page
1/4-20 Stud Adjusting Knuckle	Mobile Electronics	651-S	50
4" Aluminum Extension Bracket	Mobile Electronics	768-AL	49
8 lb. Speaker Mount	A/V	100106	38
8 lb. Stud Mount	A/V	105108	38
20 lb. Speaker Mount	A/V	110120	39
40 lb. Long Drop Ceiling Mount	A/V	120240	40
40 lb. Short Drop Ceiling Mount	A/V	120140	40
40 lb. Wall Mount	A/V	120340	41
Adjusting Knuckle	CCTV	851	35
Adjustable Extension Brackets	Mobile Electronics	767 series	49
Angle Micro Mount	CCTV	846L	27
Angle Universal Dash Mount	Mobile Electronics	75-UNI-A	48
Bench Clamp Base Mount	Work Holding	311	14
Brass Jaws	Work Holding	354	22
Circuit Board Arms	Work Holding	316	17
Circuit Board Cross Bars	Work Holding	318	17
Circuit Board Holder	Work Holding	315	12, 16
ClipCaddy	A/V, Mobile Electronics	777	39, 51
Corner/Pipe Mount	CCTV	865	34
Crimp Press Retrofit Kit	Work Holding	561	19
CCTV Camera Tree	CCTV	870	29
CCTV Camera Window Mount	CCTV	809	32
Deluxe CCTV Camera Mount	CCTV	827	30
Deluxe Micro Mount	CCTV	845-246	27
Deluxe Phone Mount	Mobile Electronics	322	54
Deluxe Shaft	Communications	327	55
Dual Option Mount	CCTV	883	31
Dual Option Telescoping Mount	CCTV	883T	31
Electronic Work Center	Work Holding	324	16
Extra-Wide Opening Head	Work Holding	376	11
Fixturing Head	Work Holding	337	12
Flat Base Plate	Mobile Electronics	960	43, 58
Flat Ribbon Cable Cutter	Work Holding	507	20
Flat Screen/Camera Mount	A/V	336-FPMC	42
Flat Screen Wall Mount	A/V	120340B	42
Flex Adapter	CCTV	817-A	32
Flex Mount	CCTV	817	32
Grooved Nylon Jaws	Work Holding	344	22
Heavy Duty Base	Work Holding	400	21
Heavy Duty Fixturing Head	Work Holding	437	21
Heavy Duty MDT Base	Mobile Electronics	400MDT	57
IDC Base Plates	Work Holding	510-513	20
IDC Assembly Press Retrofit Kit	Work Holding	506	18
J-Box Mount	CCTV	897	29
J-Box Plate	CCTV	862	34
Low-Profile Base	Work Holding	305	13
Low-Profile Head	Work Holding	304	11
Magnetic Base Mount	Work Holding	335	15
Magnetic Base	CCTV	864	34
MDT Head/Base	Mobile Electronics	336MDT	57
MDT Head/Base w/mounting holes	Mobile Electronics	305MDT	57
Micro Conduit Mount	CCTV	847	33
Micro Conduit Mount Ext. Shaft	CCTV	848-03NP	33
Micrometer Holder	Work Holding	385	12
Micrometer Stand	Work Holding	391	12
Multi-Purpose Work Center	Work Holding	350	8
Neoprene Jaw Pads	Work Holding	346	22
Neoprene Jaw Pads for PV Jr.	Work Holding	204	22
Nylon Jaws	Work Holding	343	22
PanaPress Arbor Press	Work Holding	502	18
Parts Tray Base Mount	Work Holding	312	15

Product Name	Section	Model	Page
Pass Thru J-Box Micro Mount	CCTV	898-06	28
Pass Thru J-Box Standard Mount	CCTV	899-06	28
Pass Thru Micro Mount	CCTV	848-06	26
Pass Thru Standard Mount	CCTV	849-06	30
Plated Steel Jaws	Work Holding	353	22
PortaGrip 2000 Electronics Holders	Mobile Electronics	702, 703	51
Posi-Stop	Work Holding	570	19
Premier MDT Shaft	Mobile Electronics	909	56
PV Jr. Head	Work Holding	203	10
PV Jr. Vise	Work Holding	201	6
Quick Release Interface	Mobile Electronics	675-BT	50
Rapid Assembly Circuit Board Holder	Work Holding	333	17
Replacement Guide Arm	Work Holding	532	19
Replacement Blades, Cable Cutter	Work Holding	530	20
Replacement Knobs, C. B. Holder	Work Holding	319	17
Shaft	CCTV	856	35
Slimline 2000 Pedestal Mount	Mobile Electronics	717	53
Slimline Pedestal Mount	Mobile Electronics	727	52
Slimline Interchangeable Shaft	Mobile Electronics	730	52
Solder Station	Work Holding	371	23
Solo MDT Shaft	Mobile Electronics	979	57
Square Base	CCTV	861	34
Standard Base	Work Holding	300	13
Standard Base, 90° tilt	Mobile Electronics	328	55
Standard Base, 45/45° tilt	Mobile Electronics	329	55
Standard Conduit Mount	CCTV	854	33
Standard Conduit Mount Shaft	CCTV	856-03NP	33
Standard Head	Work Holding	303	10
Standard Micro Mount	CCTV	846	26
Standard PanaVise	Work Holding	301	7
Standard Phone Mount	Mobile Electronics	320	54
Stay-Put Flex Mount	Mobile Electronics	782	59
Straight Shaft	Mobile Electronics	326	55
Straight Universal Dash Mount	Mobile Electronics	75-UNI-B	48
Surface Plate Base Mount	Work Holding	310	14
T-Bar Drop Ceiling Rail Clip	CCTV	863	34
T-Bolt Adjusting Knuckle	Mobile Electronics	651-TS	50
T-Bolt Pedestal Mount	Mobile Electronics	627	53
T-Style Adapter Plate	Mobile Electronics	670-A	50
Teflon® High Heat Jaws	Work Holding	352	22
Telescoping Shaft	CCTV	856T	33
Tipppers	Mobile Electronics	685 series	51
Tri-Foot Base	CCTV	860	34
UniFlex Mount	Mobile Electronics	797	59
Universal Radio Mount	Mobile Electronics	950, 951	54
Vacuum Base	Work Holding	380	13
Vacuum Base PanaVise	Work Holding	381	7
Vacuum Base PV Jr.	Work Holding	209	6
Vacuum Repair Kit	Work Holding	380-RK	23
Wedgie	Mobile Electronics	762	49
Weighted Base Mount	Work Holding	308	14
Wide Opening Head	Work Holding	366	11
Wide Opening Head PanaVise	Work Holding	396	8
WindowGrip Deluxe	Mobile Electronics	709B	47
Window Mounts	Mobile Electronics	809 series	46
Window Mounts	Mobile Electronics	810 series	47
Wire Manager	Work Holding	358	23
Work Station Mount	A/V	336-V75	43
Work Station Mount	A/V	336-V100	43
"Z" Aluminum Extension Bracket	Mobile Electronics	769-AL	49



PANAVISE®

7540 Colbert Drive
Reno, NV 89511-1225

+1.800.759.7535 TF

+1.775.850.2900 Tel

+1.775.850.2929 Fax

www.panavise.com

sales@panavise.com