

INSERTION TOOL ASSEMBLY		CONNECTOR		
STANDARD	REVERSE	PAIR	COLUMNS	CONTACT PIN LENGTHS mm [in.]
1804790-1	1804792-1	4	8	4.5, 6.0 [.177, .236]
1804790-2	1804792-2	4	8	5.0, 6.0 [.197, .236]
1804790-3	1804792-3	4	16	4.5, 6.0 [.177, .236]
1804790-4	1804792-4	4	16	5.0, 6.0 [.197, .236]
1804791-1	1804793-1	5	8	4.5, 6.0 [.177, .236]
1804791-2	1804793-2	5	8	5.0, 6.0 [.197, .236]
1804791-3	1804793-3	5	16	4.5, 6.0 [.177, .236]
1804791-4	1804793-4	5	16	5.0, 6.0 [.197, .236]
1804791-5	—	5	6	
1-1804791-7	—	5	10	4.5, 6.0 [.177, .236]
1901457-1	—	3	8	
1901457-2	—	3	10	4.5, 6.0 [.177, .236]
1901457-3	—	3	16	
1901788-1	—	4	8	
1901788-2	—	4	10	4.5, 6.0 [.177, .236]
1901788-3	—	4	16	

Figure 1 (Cont'd)

**NOTE**



Dimensions in this instruction sheet are in metric units [with U.S. customary units in brackets].  
Figures are not drawn to scale.

INSERTION TOOL ASSEMBLY		CONNECTOR		
STANDARD	REVERSE	PAIR	COLUMNS	CONTACT PIN LENGTHS mm [in.]
1901980-1	—	4	16	3.7, 4.5, 6.0 [.146, .177, .236]
1934957-1	—	5	8	4.5, 6.0 [.177, .236]
1934957-2	—	5	10	
1934957-3	—	5	10	
2018276-1	—	5	8	3.7, 4.5, 6.0 [.146, .177, .236]
2018278-1	—	4	8	4.4, 6.0 [.173, .236]
2018279-1	—	6	12	
2063381-1	—	6	8	4.5, 6.0 [.177, .236]
2063381-2	—	6	10	
2063381-3	—	6	16	

Figure 1 (End)

**1. INTRODUCTION**

The insertion tool assemblies listed in Figure 1 are used to seat a Z-PACK TinMan header assemblies (reference part number 1469660-1). These header assemblies have eye-of-needle compliant pin contacts to allow solderless pc board installation.

Reasons for reissue of this instruction sheet are provided in Section 8, REVISION SUMMARY.

**2. DESCRIPTION**

Each insertion tool consists of a holder, insert plates (quantity based on number of connector columns), and two dowel pins. Some insertion tools also include a special insert plate(s). The dowel pins hold the insert plates in place. See Figure 1.

The holder provides a surface to accept the force applied by the application tool to seat the header assembly onto the pc board. During seating, the insertion tool sits inside the header assembly and the insert plates prevent the contacts from pushing out of the header assembly.

**3. REQUIREMENTS**

**3.1. PC Board Support Fixture** (Customer Supplied)

A pc board support must be used to provide proper support for the pc board and to protect the pc board and header assembly from damage. The board support fixture must be designed for specific needs using the following recommendations:

- it should be at least 25.4 mm [1 in.] wider than the pc board
- it should have a flat surface with a cutout of at least 28.5 mm [1.12 in.] deep (to allow adequate clearance for the header assembly)

**3.2. Application Tooling**

Power for the insertion tool must be provided by application tools (with a ram) capable of supplying a downward force of 44.5 N [10 lb] per contact. For available application tools, call PRODUCT INFORMATION at the number at the bottom of page 1.



*Over-driving of the header assembly could cause damage to the pc board.*

**4. SETUP**

When setting up equipment to seat the header assembly, pay particular attention to the following:

- the insertion tool must be matched to the header assembly



*If the insertion tool and header assembly are mismatched or are improperly aligned, damage could occur to the tooling, header assembly, or both.*

- the insertion tool, header assembly, and application tool ram must be properly aligned before cycling the application tool

Set the seating height to the dimension shown in Figure 2 (application tool *shut height* will equal the seating height PLUS the combined thicknesses of the pc board and support fixture). After insertion, a gap of no more than 0.10 mm [.004 in.] between the header assembly standoffs and the pc board is allowed.



*Use the seating height as a reference starting point. This height may need to be adjusted to obtain the amount allowed (maximum of 0.10 mm [.004 in.]) between the standoffs of the header assembly and the pc board.*

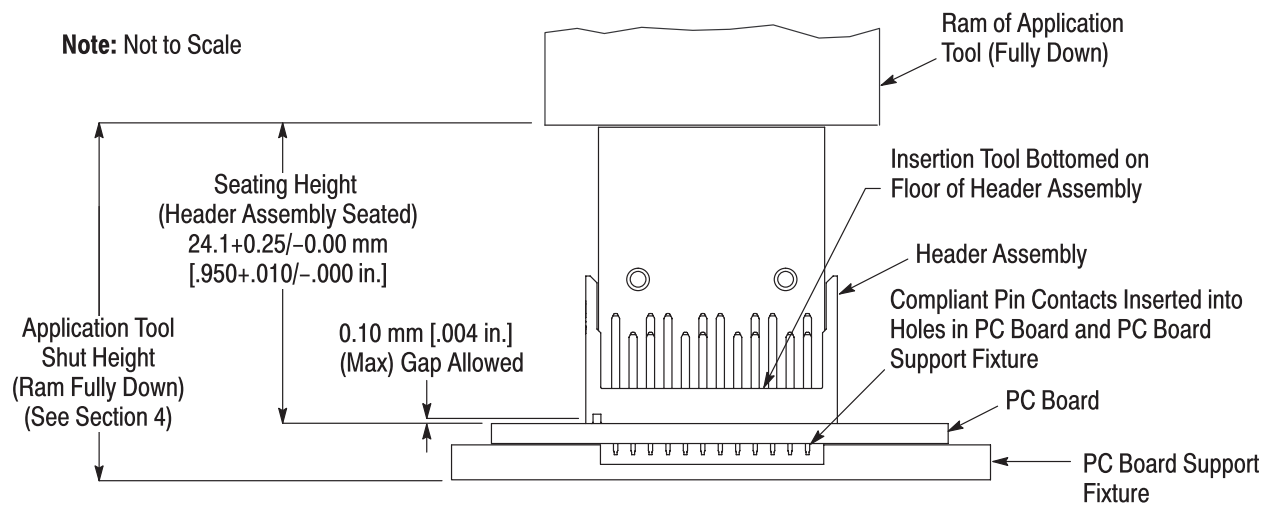



Figure 2

**5. INSERTION** (See Figure 2)

1. Place the pc board on the support fixture.
2. Place the header assembly on the pc board so that the contacts are aligned and started into the matching holes in the pc board.
3. Orient the insertion tool over the header assembly so that the insert plates face the alignment slots of the header assembly. Then lower the insertion tool into the header assembly, until the insertion tool bottoms on the floor of the header assembly.

**CAUTION**  To avoid damage to the header assembly, the insertion tool must bottom on the floor, NOT ON THE CONTACTS, of the header assembly before cycling the application tool. If the insertion tool bottoms on the contacts, the insertion tool and header assembly are mismatched.

4. Center the insertion tool (with the header assembly) under the ram of the application tool. Slowly lower the ram until it just meets the insertion tool. Verify alignment of pc board support, pc board, header assembly, and insertion tool.

**CAUTION**  Damage to the pc board, insertion tool, or header assembly may occur if the insertion tool is not properly inserted into the header assembly before cycling the application tool.

5. Cycle the application tool to seat the header assembly on the pc board. Then retract the ram, and carefully remove the insertion tool by pulling it straight from the header assembly.
6. Check the header assembly for proper insertion according to the following:

- a. the widest section of each compliant pin is inside its intended pc board hole
- b. the header assembly is seated on the pc board with the seating height—measured from the top of the header assembly to the top of the pc board—given in Figure 2.
- c. if present, the gap between the standoffs and the pc board is no more than 0.10 mm [.004 in.]

**CAUTION**  Damage product should not be used. If damaged product is evident, it should be removed from the pc board and replaced with a new one.

**NOTE**  For detailed application requirements of the header assembly, refer to Application Specification 114-13144.

**6. MAINTENANCE AND INSPECTION**

The insertion tool is assembled and inspected before shipment. It is recommended that the insertion tool be inspected immediately upon arrival at your facility to ensure that it has not been damaged during shipment and that it conforms to the dimensions provided in Figure 3.

**6.1. Daily Maintenance**

It is recommended that each operator be made aware of, and responsible for, the following steps of daily maintenance:

1. Remove dust, moisture, and contaminants with a clean, soft brush or a lint-free cloth. DO NOT use objects that could damage the insertion tool components.
2. When the insertion tool is not in use, store it in a clean, dry area.

**6.2. Periodic Inspection**

Regular inspections should be performed by quality control personnel. A record of scheduled inspections should remain with the insertion tool or be supplied to personnel responsible for the insertion tool.

Inspection frequency should be based on amount of use, working conditions, operator training and skill, and established standards.

quality and reliability. Order replacement parts through your representative, or call 1-800-526-5142, or send a facsimile of your purchase order to 717-986-7605, or write to:

CUSTOMER SERVICE (038-035)  
 TYCO ELECTRONICS CORPORATION  
 PO BOX 3608  
 HARRISBURG PA 17105-3608

For customer repair service, contact a representative at 1-800-526-5136.

**7. REPLACEMENT AND REPAIR**

Customer-replaceable parts are listed in Figure 3. A complete inventory should be stocked and controlled to prevent lost time when replacement of parts is necessary. Parts other than those listed should be replaced by Tyco Electronics to ensure

**8. REVISION SUMMARY**

Revisions to this instruction sheet include:

- Added insertion tool assemblies

**Standard Insertion Tool**

First Plate Installed with Straight Corner Facing Out and Every Other Plate Rotated 180°

**Note:** Insertion Tool 1901980-1 Shown

**Reverse Insertion Tool**

First Plate Installed with Notched Corner Facing Out and Every Other Plate Rotated 180°

**Note:** 4-Pair Insertion Tool Shown

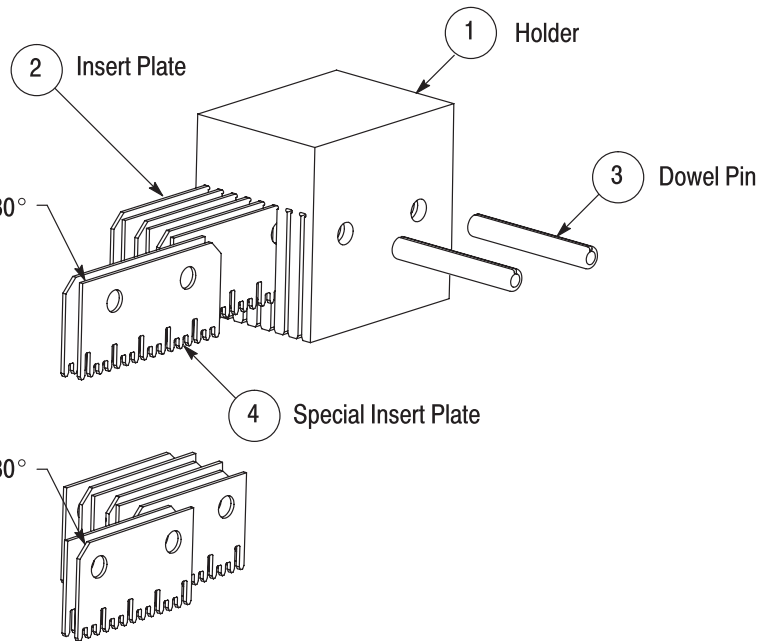

ITEM	REPLACEMENT PART NUMBER								QTY PER TOOL	
	1804790 (Standard) and 1804792 (Reverse)				1804791 (Standard) and 1804793 (Reverse)					1804791-5 (Standard)
	-1	-2	-3	-4	-1	-2	-3	-4		
1	1804794-1		1804794-2		1804795-1		1804795-2		1804795-3	1
2	1804796-1	1804796-2	—		1804797-1	1804797-2	—		—	8
	—		1804796-1	1804796-2	—		1804797-1	1804797-2	—	16
	—		—		—		—		1804797-2	6
3	1-21919-3		2-21919-9		1-21919-3		2-21919-9		2-21919-9	2

Figure 3 (Cont'd)

1-1804791-7 (Standard)		
ITEM	REPLACEMENT PART NUMBER	QTY PER TOOL
1	1804795-5	1
2	2018023-1	10
3	1-21919-5	2

ITEM	REPLACEMENT PART NUMBER							QTY PER TOOL
	1901457 (Standard)			1901788 (Standard)			1901980-1 (Standard)	
	-1	-2	-3	-1	-2	-3		
1	1901459-1	1901459-2	1901459-3	1901787-1	1901787-2	1901787-3	1804794-2	1
2	1901458-1	—		1804796-3	—		—	8
	—	1901458-1	—	—	1804796-3	—	—	10
	—		1901458-1	—		1804796-3	—	16
	—		—	—	—	—	1804796-1	15
	—		—	—	—	—	—	6
3	1-21919-3	1-21919-4	2-1919-9	1-21919-3	1-21919-4	1-21919-9	2-21919-9	2
4	—		—	—		—	1976070-1●	1

ITEM	REPLACEMENT PART NUMBER			
	1934957 (Standard)			QTY PER TOOL
	-1	-2	-3	
1	1934958-1	1934958-2	1934958-3	1
2	1934959-1	—	—	8
	—	1934959-1	1934959-1	10
3	1-21919-3	1-21919-4	1934961-1	2

ITEM	REPLACEMENT PART NUMBER						QTY PER TOOL
	2018276-1 (Standard)	2018278-1 (Standard)	2018279-1 (Standard)	2063381-1 (Standard)	2063381-2 (Standard)	2063381-3 (Standard)	
1	1804795-1	2031941-1	2031938-1	2063383-1	2063383-2	2063383-3	1
2	1804797-1	—	—	—	—	—	6
	—	2031942-1	—	2063382-1	—	—	8
	—	—	2031939-1	—	—	—	12
	—	—	—	—	2063382-2	—	10
	—	—	—	—	—	2063382-3	16
3	1-21919-4	1-21919-4	1-21919-6	1-21919-3	1-21919-4	2-21919-9	2
4	2063016-1●●	—	—	—	—	—	2

● Located in Right End Slot

●● 1 Located in Each End Slot

Figure 3 (End)