

**INDUSTRIAL CRIMP QUALITY  
HANDBOOK  
Order No. 64016-0065**

## Table of Contents

### SECTION

- 1 Introduction to Crimp Technology
- 2 Purpose and Scope
- 3 Definitions and Terms
- 4 Associated Materials
- 5 Terminal Description
  - 5.1. Features of Solderless Terminals
  - 5.2. Barrel Serration/Dimples
  - 5.3. Barrel Styles
  - 5.4. Splices
- 6 Procedures
  - 6.1. Preparing the Wire
  - 6.2. Setup and Operation of a Press
  - 6.3. Setup and Operation of a Hand Crimp Tool
  - 6.4. Setup and Operation of a Air Powered Crimp Tool
  - 6.5. Crimping Dies
- 7 Quality Crimps
  - 7.1. Visual Inspection of OPEN BARREL Crimps
  - 7.2. Visual Inspection of CLOSED BARREL Crimp
- 8 Importance of Proper Crimping
  - 8.1. Conditions
  - 8.2. Testing
  - 8.3. Final Tensile Value
  - 8.4. Electrical Resistance
  - 8.5. Crimp joints
- 9 Miscellaneous

## SECTION 1

### INTRODUCTION TO CRIMP TECHNOLOGY

Developed to replace the need to solder terminations, crimping technology provides a high quality connection between a terminal and a wire at a relatively low applied cost. The methods for applying crimp terminations depend on the application, volume, and range from hand-held devices to fully automated systems.

The application methods include a basic hand tool, a press and die set, a stripper crimper, or a fully automatic wire processing system. However, no matter what method is used, the setup of each tool is critical for achieving a quality crimp.

Today, many OEM companies are using Statistical Process Control (SPC) to continuously improve their crimp terminations. Crimp termination is a complex process and to ensure consistent quality it is necessary to understand the variability and inter-relational interactions that the technology involves.

Without a thorough understanding of the crimping process, and all the factors that can affect it, the result may not meet expectations. The three key elements in the crimping process are the terminal, the wire, and the tooling.

#### Terminal

For most applications, it is not economically practical for connector manufacturers to design a terminal to accept one wire size, one wire stranding, and one insulation diameter (UL type) as well as Mil Specification. Most terminals accommodate many wire sizes, stranding, and a range of insulation diameters, and the terminals are designed to meet acceptable levels over this entire range.

#### Wire

The wire stranding and insulation type can vary widely within one wire size. For example, there is more than 18% more material in an 18 AWG by 19-strand wire than an 18 AWG by 16-strand wire. The insulation diameter of an 18 AWG wire can range from 1.78mm (.070") to over 4.57mm (.180"). Wire strands can be copper, tinned, over coated, or top coated. Wire insulation materials, thickness, and durometers vary from application to application.

#### Tooling

What type of tooling does the application require? Does the application require hand stripping of the wire or does the volume dictate an automatic wire-stripping machine? Does the application and volume require hand tools, press and die, or fully automatic wire process machines? Crimping with a manual hand tool, semi-automatic press and die, or fully automatic wire processor, all involve different levels of variability. The terminal, wire, and type of application tooling all affect the quality of the completed terminations.

## SECTION 2

### PURPOSE AND SCOPE

#### Purpose

This handbook provides general guidelines and procedures for understanding and achieving acceptable crimp terminations. A glossary in Section 3 lists common terms and definitions. Section 4 lists the tools that are necessary to take accurate measurements and evaluate the crimp's acceptability.

For open barrel only, the tooling setup is critical in determining the quality of the finished crimp. The attributes that need to be considered include crimp height, conductor brush, bell mouth, cut-off tab and strip length and insulation position. Variability in one or more of these attributes can reduce the measured pull force. It can be difficult to establish acceptable variability limits because the attributes all interact with one another.

For example, a track adjustment for bell mouth also will change the cut-off tab length and the insulation wire position while strip length and wire locations affect the conductor brush and insulation position. Adjusting the insulation crimp height may result in a slight change to the conductor crimp height measurement. It may be necessary for the setup person to make multiple adjustments to establishing an optimal setup.

The order in which a setup is done may help reduce the number of repetitions required for an optimum setup.

This handbook is structured so that parts, or all, of its contents can be used as a procedural guide for ISO requirements.

#### Scope

**This handbook is intended for Molex customers who are crimping Molex open and closed barrel crimp terminals and are using Molex tooling.**

The handbook's contents may slightly differ from other connector manufacturers' or individual company guidelines and procedures.

This handbook provides a basic overview of what to look for in an acceptable crimp. It is not intended to replace individual product and/or tooling specifications.

Individual terminals or applications may have special requirements. Tooling limitations also may not permit an attribute to be adjusted to meet optimum requirements.

## SECTION 3

### DEFINITIONS AND TERMS

- **AWG**  
Acronym for American Wire Gauge. It is the most popular of many systems for designating single, round, solid, non-steel wire diameter in United States of America. Stranded wires are designated based on comparison of their total cross-sectional area of the conductor part only (their current carrying capacity) and cross-sectional area of a corresponding solid wire.
- **Barrel**  
It is the back end portion of a terminal or contact. It is crimped to the conductor, insulation, or both. When designed to receive the conductor, it is called the conductor barrel. When designed to support or grip the insulation, it is called the insulation barrel.
- **Bell Mouth**  
This is the undisturbed portion of the conductor barrel nearest the insulation crimp. It is the result from the actual crimping, which acts as a funnel for the wires and reduces the possibility of a sharp edge on the barrel cutting or nicking the wires.
- **Bend Test**  
One way to test the insulation crimp is by bending the wire several times and then evaluating the movement of the insulation and wire strands. As a rule, the insulation crimp should withstand the wire being bent 60 to 90 degrees in any direction, several times. Use care when working with small wire sizes so the wire at the back of the insulation crimp does not shear.
- **Butt Splice**  
It is a device to join two conductors, end-to-end, rather than overlapping.
- **Chamfer**  
An angle on the inside edge of the barrel entrance of a terminal that permits easier insertion of the wires into the barrel.
- **Circular Mil (CM)**  
A unit of area used to indicate wire size. It is the computed total cross sectional area of conductors. One circular mil equals cross-sectional area of a wire one mil (0.001 inches) in diameter.  
CMA – acronym for Circular Mil Area
- **CMA**  
Acronym for Circular Mil Area
- **Contact Area**  
It is the area in contact between two conductors, or a conductor and a connector permitting the flow of electricity.
- **Conductor Brush**  
The conductor brush is made up of the wire strands that extend past the conductor barrel on the contact side of the terminal. This helps ensure that mechanical compression occurs over the full length of the conductor crimp. The conductor brush should not extend into the contact area.

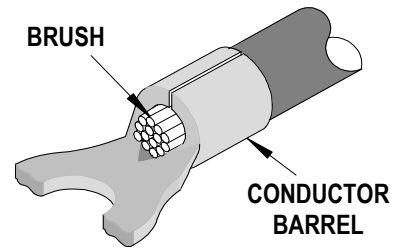

terminal plating, one crimp height specification is normally created.

\*Consult individual terminal specification requirements.

■ **Crimp**

It is the act of physically compressing (forming) a connector or contact barrel around a cable in order to make an electrical connection. On a crimped terminal, a second crimp is often added to the insulation area for added strain relief.

■ **CSA**

Canadian Standards Association is an independent Canadian testing laboratory similar to UL (Underwriters Laboratories Inc.).

■ **Cut-off Tab Length**

This material protrudes outside the end of the terminal after the terminal is separated from the carrier strip. As a rule, the cut-off tab should be flush or .254mm (.010") protruding outside the housing sleeve. A cut-off tab, which is too long, may expose a terminal outside the housing or it may fail electrical spacing requirements. In most situations, a tool is set-up to provide a cut-off tab that is flush to one material thickness.

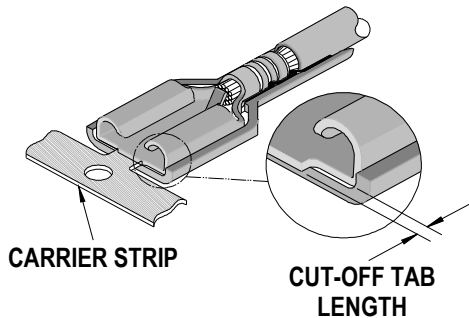

■ **Dielectric Test**

A test that uses the application of a voltage higher than the rated voltage for a specific time for the purpose of determining the adequacy against breakdown of insulation materials and spacing under normal conditions. This test is used to ensure the crimping procedure did not puncture or destroy the insulation material on the terminal.

■ **Extrusions (Flash)**

These small flares form on the bottom wire barrel resulting from the clearance between the punch

and anvil tooling. If the anvil is worn or if the terminal is over-crimped an excessive extrusion results. An uneven extrusion may also result if the punch and anvil being misaligned.

■ **Ferrule**

A short tube used to mate solderless connectors to shielded or coaxial cable. It is used as an insulation grip sleeve on solderless terminals.

■ **Flash**

It is an abnormal protrusion on the wire barrel, (either insulation material or metal), which indicates that the crimping tool is either misaligned or worn and thus should not be used.

■ **Funnel Entry**

It is a crimped terminal or splice barrel, which opens to facilitate quick and easy wire insertion.

■ **Gas Tight Seal**

A contact system that utilizes soft metals at high contact pressures so that upon mating, metal is upset and the resultant joint prevents contaminant gases from entering the contact area.

■ **Gauge**

A method of measurement, often using "go" and "no-go" pins or shapes to determine if an attribute is within tolerance.

■ **Harness**

A group of wires or cables joined to form a circuit network for electronic or electrical equipment. A harness is usually an assembly of cables cut to the proper length, terminated, and tied together prior to being assembled in a piece of equipment.

■ **Insulation Crimp (Strain Relief)**

It is a crimp encompassing both the wire and insulation. This helps to prevent the conductor from being exposed due to the insulation receding and offers additional resistance to vibration.

■ **Insulation Crimp Height**

Molex does not specify insulation crimp heights because of the wide variety of insulation thickness, material, and hardness. Most terminals are designed to accommodate multiple wire ranges.

Within the terminal's range, an insulation grip may not completely surround the wire or fully surround the diameter of the wire. This condition will still provide an acceptable insulation crimp for most applications.

- ✓ A large insulation grip should firmly grip at least 88% of the wire.
- ✓ A smaller insulation grip should firmly grip at least 50% of the wire and firmly hold the top of the wire.

To evaluate the insulation section, cut the wire flush with the back of the terminal. Once the optimum setting for the application is determined, it is important to document the insulation crimp height. Then, as part of the setup procedure, the operator can check the insulation crimp height.

- **Locator**  
A device for positioning terminals, splices, or contacts in crimping dies.
- **MCM (or kcmil)**  
Unit of area, based on Circular Mil, equal to one thousand circular mils. Usually used instead of AWG above wire sizes greater than 4/0 AWG.
- **Mega (mega, M)**  
Prefix denoting one million, e.g., one megavolt = one million volts.
- **Micro (micro, μ)**  
Prefix denoting one millionth, e.g., one microvolt = one millionth of a volt.
- **Mil Spec**  
Military Specification. A specification used for qualification of products for acceptability as required for U.S. Government applications (usually for a military branch), e.g. Mil-T-7928 covers terminals, lugs, splices, conductors, crimp style.
- **Mechanical Strength**  
To insure how strong the connection is or how much the wire and terminal must be squeezed to get a gas tight seal. It's important to crimp the wires tight enough to keep them from slipping out of the connector, but not so tight as to crush the wires in

the terminal, causing them to break off. The connection is weakened if the wires are cut or nicked.

- **Nest**  
The portion of a crimping die, which supports or reshapes the barrel during crimping.
- **PSI, psi**  
(Pound-Force per Square Inch) Non-SI unit of pressure. Used mainly to denote pressure of air or other gas, e.g. 75 psi.
- **Pound-Force (lbf)**  
Unit of force, 1lbf is approximately equal to force exerted on a mass of 1 lb by gravitational force of Earth at its surface, or a force exerted by that mass (stationary) on a support (i.e. if mass of 1 lb is hung on a wire, it exert a force of ca. 1 lbf (directed down) on that wire).
- **Pull Force Testing**  
Pull force testing is a quick, destructive method to evaluate the mechanical properties of a crimp termination.

Pull force testing results out of allowed range are good indicators of problems in the process. Cut or nicked strands in the stripping operation, lack of bell mouth or conductor brush, or incorrect crimp height or tooling will reduce pull force. Wire properties and stranding, and terminal design (material thickness and serration design), also can increase, or decrease the value of the results of a pull force test.

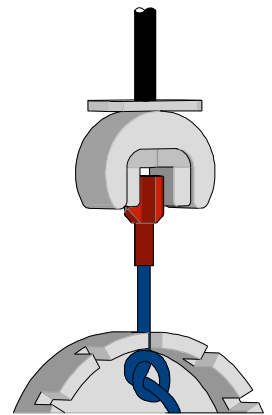

If results of a pull force tests are within an allowed range, it assures that proper crimp force has been applied during crimping. It is crucial as, when making a crimp, enough force must be applied to break down the layer of non-conductive oxides that may build up on the stripped conductor and the tin-plating on the inside of the terminal grip. This is necessary to provide a good metal-to-metal contact.

If this does not occur, resistance can increase. Over-crimping a crimp termination will reduce the circular area of the conductor and increase resistance.

- **Serrations**  
It is the saw-toothed grooves on the surface of a terminal, which ensures firm gripping of the conductor. Also provides additional contact area.
- **Solderless**  
This means without solder – in our case, denoting the use of a crimping tool.
- **Splice**  
A device used to join two or more conductors together.
- **Strip Length**  
The strip length is determined by measuring the exposed conductor strands after the insulation is removed. The strip length determines the conductor brush length when the insulation position is centered.

\*Consult individual terminal specification requirements

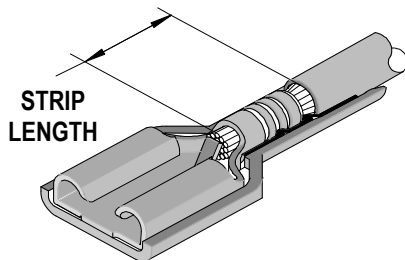

- **Tab**  
Flat rectangular male connection tabs on electrical components; various sizes to fit female quick disconnects.
- **Tensile Test**  
This is a pull test to determine the mechanical strength of the crimped wire. They are specific minimum values set for each wire size. See Section 8.
- **Terminal**  
A device designed to terminate a conductor that is to be affixed to a wire or cable to establish an electrical

connection. It is a synonym for contact. There are two main types, which include the open barrel and the closed barrel. Parts of the terminal are:

- Insulation barrel Where the wire's insulation will be crimped or supported so that it is firmly gripped.
- Wire barrel Where the bare wire will be crimped.
- Contact area Where the terminal will be attached to the mating part.

- **Terminal Position**  
The terminal position is set by the alignment of the terminal to the forming punch and anvils, and the carrier-strip cut-off tooling. The tool set-up determines conductor, cut-off tab length, and terminal extrusions.

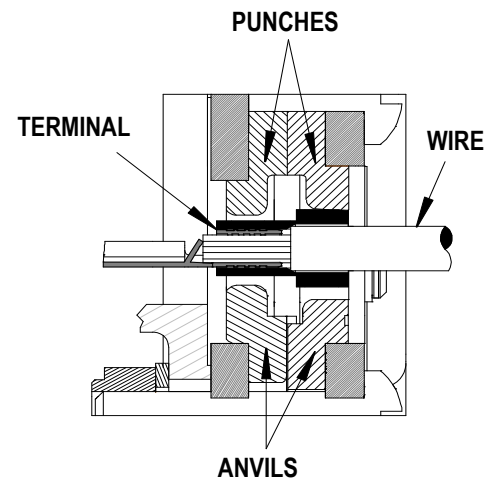

- **UL**  
Underwriters' Laboratories, Inc., founded in 1894, is chartered as a not-for-profit organization under the laws of Delaware, to establish, maintain, and operate laboratories for the investigation of materials, devices, products, equipment, construction methods, and systems with respect to hazards affecting life and property.
- **Voltage Drop Test**  
A test of the voltage developed across a component or conductor being a result of electric current flow in the component or conductor and its non-zero electrical resistance. It is the test of the electrical integrity of the crimp.
- **Wire**  
They are a group of conductors that has a low resistance to current flow, together with any



associated insulation. There are two kinds: a solid wire, which is one single strand of material, or stranded group of wire, which is a bundle of wires twisted together to act as one.

■ **Wire Size**

Wires have varying sizes or gauges that carry different amounts of electrical current with each wire used for a separate purpose. The size (in AWG) is called out with a number, such as 8 or 10, followed by the letters AWG, which stand for American Wire Gauge.

■ **Wire Stop**

It is a stop at the end of a terminal wire barrel. It prevents wire from passing completely through the barrel so the wire will not interfere with the function of the contact.

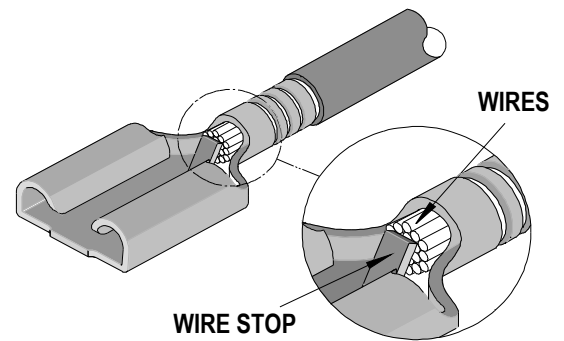

**SECTION 4**

**ASSOCIATED MATERIALS**

■ **Caliper**

It is a gauge, consisting of two opposing blades, for measuring linear dimensional attributes.

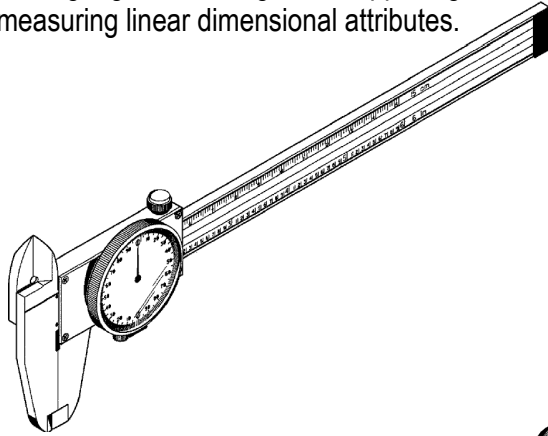

■ **Eye Loupe**

It is an image magnification tool, normally 10 times power or greater, which is used to aid visual evaluation of a crimp termination.

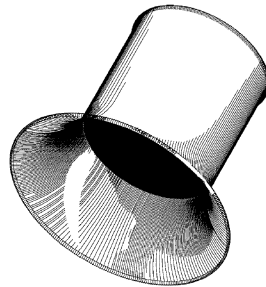

■ **Crimp Micrometer**

This is a micrometer specifically designed to measure crimp height. The measurement is taken in the center of the crimp so the conductor bell mouth does not influence it. It has a thin blade that supports the top of the crimp while a pointed section determines the bottom radial (curved) surface.

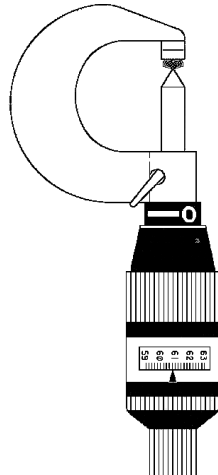

■ **Ruler (Pocket Scale)**

This is used to measure the length of bell mouth, cut-off tab, conductor brush, and strip length and estimate wire position. The recommended minimum resolution is 0.50mm (.020”).

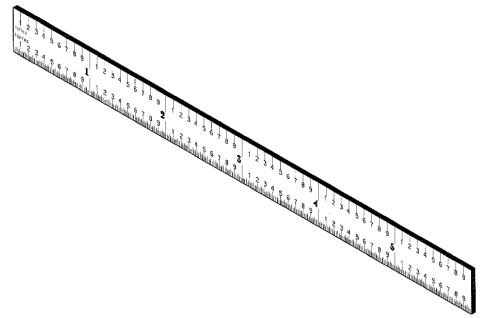

■ **Pull Tester**

A device used to determine the mechanical strength of a crimp termination. Most pull testing is done with a device that clamps the wire, pulls at a set speed, and measures force by means of a load cell. A pull tester also can be as simple as hanging fixed weights on the wire for a minimum of one minute.

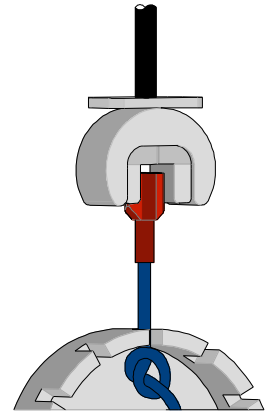

■ **Toolmaker's Microscope**

This is used for close visual evaluation and statistical measurement of bell mouth, cut-off tab, conductor brush, wire position, and strip length.

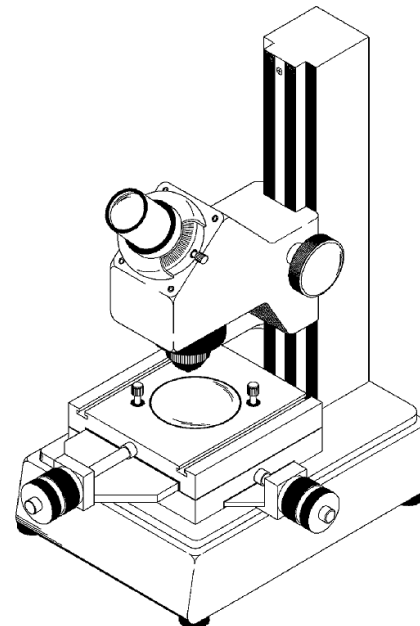

## SECTION 5

### TERMINAL DESCRIPTION

#### 5.1 Features of Solderless Terminals

The properties of the base material must be evaluated. The material (metal) is either copper or brass depending on the product.

- Molex base metals are purchased, inspected, and received to product specifications.
- Most of these terminals are applied the guidelines of UL; Underwriters Laboratories is a US organization that sets certain standards for connector testing.
- Some terminals use the guidelines of Mil-T-7928, set by the United States Government.

The following charts show the UL and US Government specifications (MIL-T-7928) for wire pull-out forces of various wire sizes. The tensile strength is shown in lbf (pound-force). It indicates the minimum acceptable force to break or separate the terminal from the conductor.

Color Code	Wire Size (AWG)	*UL - 486 A	*UL - 486 C	*UL - 310	*Military Class 2
Yellow	26	3	N/A	N/A	7
Yellow	24	5	N/A	N/A	10
Red	22	8	8	8	15
Red	20	13	10	13	19
Red	18	20	10	20	38
Blue	16	30	15	30	50
Blue	14	50	25	50	70
Yellow	12	70	35	70	110
Yellow	10	80	40	80	150
Red	8	90	45	N/A	225
Blue	6	100	50	N/A	300

\*UL - 486 A - Terminals (Copper conductors only)

\*UL - 486 C - Butt Splices, Parallel Splices, Closed End Connectors, and Wire Nuts

\*UL - 310 - Quick Disconnects, Flag and Couplers

\*Military Class 2- Military Approved Terminals only as listed

#### 5.2 Barrel Serration/Dimples

1. When quality solderless terminals are stamped, the inside of the barrel is scored with serrations or dimples.
2. When the crimp is made and the metal terminal barrel is drastically deformed, the tin plating on the inside of the barrel is fractured at the serrations, thus causing bare copper-to-copper contact between the wire and the terminal barrel. This greatly enhances electrical conductivity.
3. If properly designed, the serrations, or dimples, have angled grooves that, during the crimping operation, will bite into the wire, which will greatly increase the mechanical integrity of the crimp.
4. A quality solderless terminal has features built into the barrel that insures a quality crimp.
5. The non-insulated terminal will have a chamfer at the wire insertion end so the individual strands will not bump against the end of the metal.
6. On an insulated terminal the insulation should have a funnel entry. This acts as a guide for the wires to enter the barrel smoothly.
7. There are two styles of insulated barrels. Both have a funnel feature.

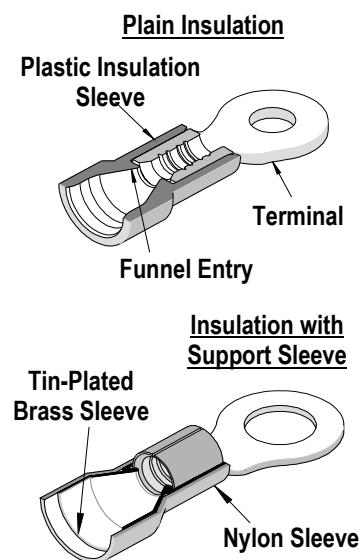

### 5.3 Barrel Styles

The barrel is the part of the terminal that is crimped around the wire. Molex offers different styles listed below.

1. The **Krimptite™** is the basic Molex barrel style. It is non-insulated and is a one-piece design. This terminal is the most economical and has the greatest variety of uses where special features are not required. It is available in 10 to 26 AWG (0.10 to 6.60mm<sup>2</sup>).

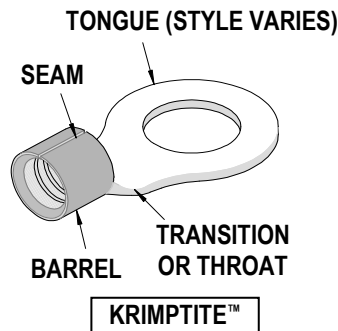

2. The **Versakrimp™** is the same as the Krimptite™, except the seam is brazed (welded) closed. This brazed-seam barrel terminal will not open under conditions of stress or wire pull. This allows for crimping from any direction without the barrel opening up, and provides greater tensile strength. This terminal is ideal for hard to crimp solid and stranded wires. It is available in wire range 4/0 to 22 AWG (0.10 to 117.00mm<sup>2</sup>).

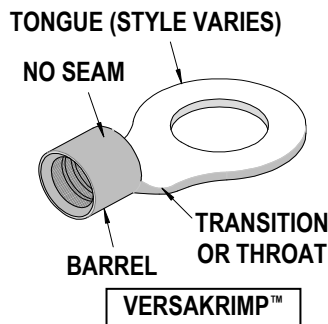

3. The **Insulkrimp™** has a rigid insulation sleeve made of PVC (polyvinyl chloride), which protection to the Krimptite barrel area in wire sizes of 10-22 AWG or the brazed seam of the Versakrimp barrel of 4/0 to 22 AWG. It is available in wire range 4/0 to 22 AWG (0.10 to 117.00mm<sup>2</sup>).

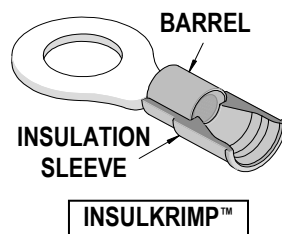

4. The **Avikrimp™** has a color-coded sleeve, which provides insulation as well as an insulation grip. The insulation is made of Nylon, and has a secondary tin-plated brass sleeve added. This brass support sleeve is crimped around the wire

insulation providing a strain relief, so the wire does not vibrate, loosen, fray, or break. It is available in 10 to 26 AWG (0.10 to 6.60mm<sup>2</sup>).

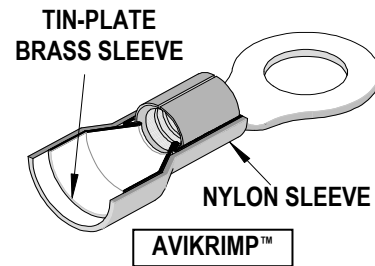

5. The **Open Barrel** product is used in manufacturing operations where quantity of work is needed. The open barrel allows the wire to be crimped faster and easier and is the barrel style preferred when using automated wire processing equipment.

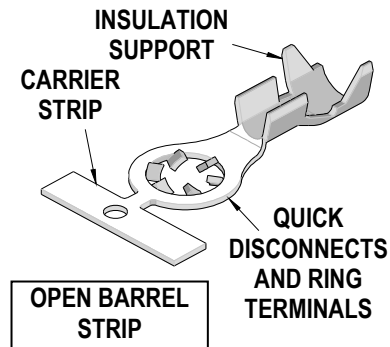

6. The **Nylakrimp™** is specifically designed for large wire applications. The color-coded barrel is affix with a permanent rigid color-coded nylon insulated sleeve. It has a funnel entrance that eliminates wire strand fold back. It is available in wire range 4/0 to 8 AWG (8.50 to 117.00mm<sup>2</sup>).

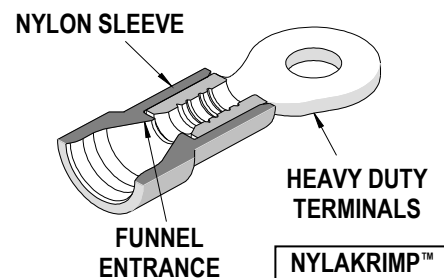

7. The **Perma-Seal™** is specifically designed for water resistant applications. The color-coded barrel has a permanent rigid color-coded nylon insulated sleeve. It has a funnel entrance that eliminates wire strand fold back. It is available in wire range 10 to 22 AWG (0.10 to 6.60 mm<sup>2</sup>).

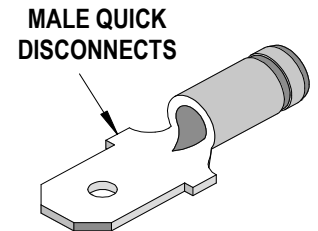
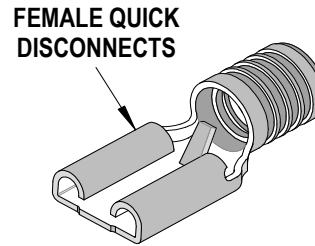
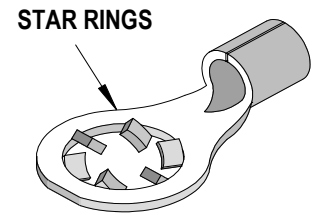
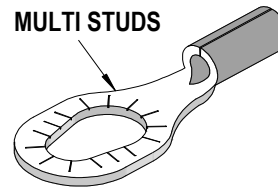
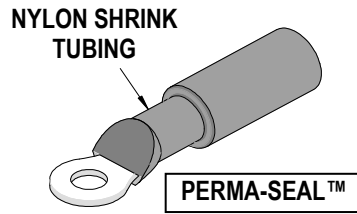

8. The **Eyelet** can be used in place of standard compression terminals because it is deep drawn from CDA-110 electrolytic pitch copper and then tin-plated for corrosion resistance. It has a seamless barrel with a flared barrel entry. It is available in wire range 8 to 500 MCM.

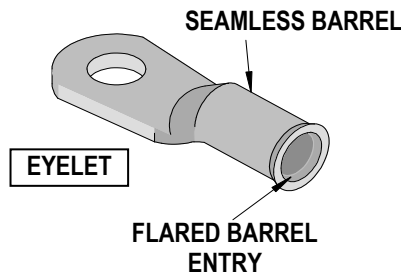

■ **Tongue Styles**

The “tongue” is the end of the terminal that attaches to other components (switch, stud, transformer, etc.). These tongue configurations vary. The following are some examples:

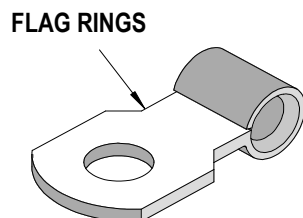
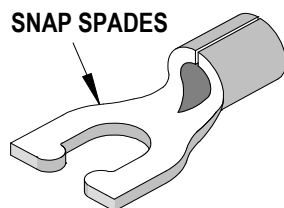
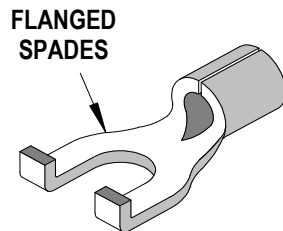
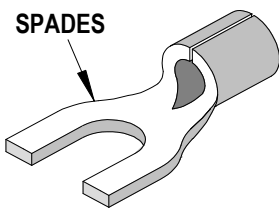
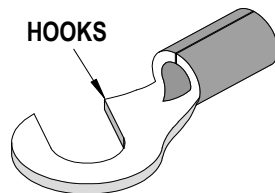
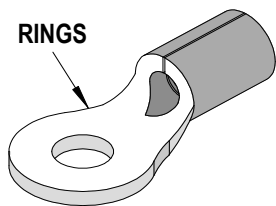

■ **Barrel Lengths**

In wire sizes 26-16 AWG, the industry has two standard barrel lengths for the metal barrel. The lengths are 6.35 mm (.25”) and 4.36 mm (11/64”). The 4.36 mm barrel is the OEM (Original Equipment Manufacturer) standard barrel length. The 6.35 mm barrel is more commonly used in the maintenance and aftermarket segments of industry.

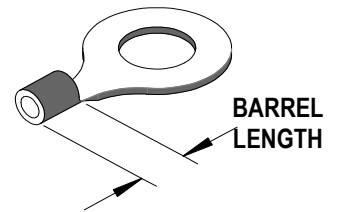

The purpose of the longer barrel is simply to give the user a bigger target area to crimp. These barrel lengths are not so important if you use a terminal with the molded step construction on the insulation, or if a precision ratchet tool with terminal locator is used. OEM tooling is usually designed for only short barrel terminals.

■ **Step Construction Insulation for Tool Location**

The “step” on the insulation of molded terminals is used to position (locate) the crimping tool. The tool should rest on the step and crimp made just above it. This insures that the entire width of the crimping tool is hitting on the barrel below. This step construction is very important when using a non-ratchet maintenance tool without a locator.

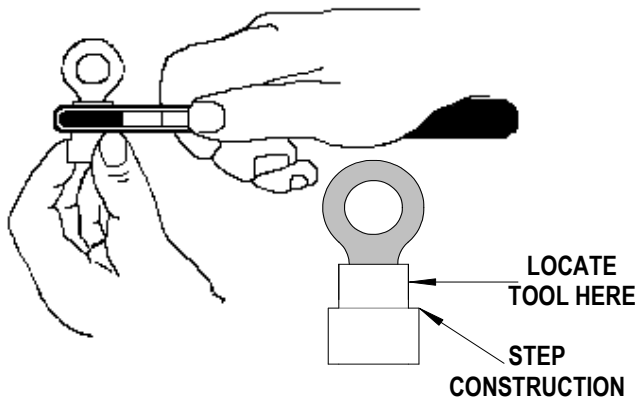

**Insulation Barrel Colors**

The colors on the insulation barrel (red, blue, and yellow) are used to indicate the wire range. The colors repeat themselves and are an industry standard color-coding. See the Chart below.

Color Code	Wire Range (AWG)
Yellow	24-26
Red	18-22
Blue	14-16
Yellow	10-12
Red	8
Blue	6
Yellow	4

There are different kinds of barrels with different shades of the same color, which are used for different barrel styles. PVC and Nylon take the color differently. In the 14-16 AWG range (blue) for example, the PVC barrels will be dark blue. The nylon barrels will be a lighter, translucent blue. When using the lighter blue terminals, the secondary sleeve will be crimped in addition to the wire barrel crimp. The actual shade of color has nothing to do with quality of the insulation.

**5.4 Splices**

Molex offers standard and special splices for nearly every type of wiring need.

**Butt Splices**

On this connector, the stripped wires are inserted from each end and they "butt" in the center. Then a crimp at each end secures the connection.

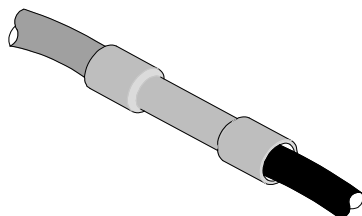

**Step Down Butt Splices**

The Step Down Butt Splice is the perfect solution when two wires need to be inserted in one end of a splice and a single wire in the other end.

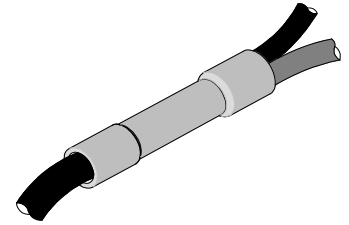

**Avikrimp® Butt Splice**

With the extra metal sleeve and nylon insulation, these splices should be used when heavy vibration is anticipated and a strong strain relief is needed.

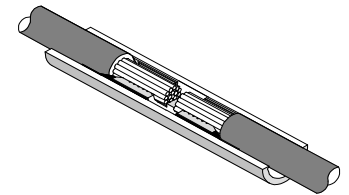

**Nylon Closed-End Connector**

Used in a wide variety of situations to "pigtail" or tie together two or more wires.

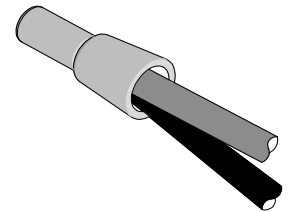

**Funnel Entry Butt Splice**

In the past, the crimping of machine terminated butt splices has been difficult and nearly impossible if attempted on a piece of robotic equipment. Now, with our new Funnel Entry Butt Splice, the end that will be crimped by the crimping press is funneled to allow quick and easy wire insertion.



**Perma-Seal Splices™**

The tough sleeve of Perma-Seal splices resist abrasion and cutting. This protective helps to maintain the insulation and sealing properties even in hostile environments, not to mention unbeatable strain relief.

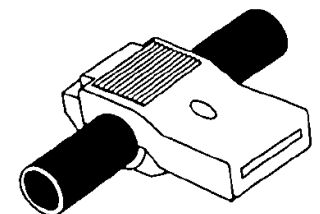

■ **Parallel Splice**

This connector has stripped wires that lie side-by-side in the splice. They are secured by a single crimp in the middle.

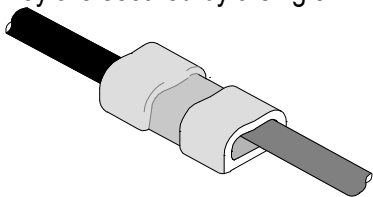

■ **Window Butt Splice**

This connector has military approval (Mil-T-7928/5) to withstand the harshest environments. The window guarantees proper wire insertion and crimp tool alignment. They are nylon insulated and have an insulation grip that provides superior strain relief.

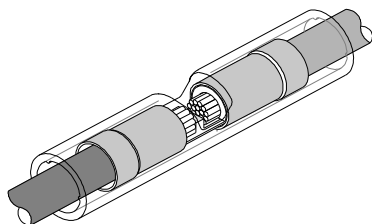

## SECTION 6

### PROCEDURES

#### 6.1 Preparing the Wire

Check the stranded wire to see if any strands have loosened and expanded to be larger than the wire and the insulation together. If this has occurred, twist the wires to the size they were before they were stripped. Be sure that the stranded wire is within the outside diameter of the insulation after you have twisted them.

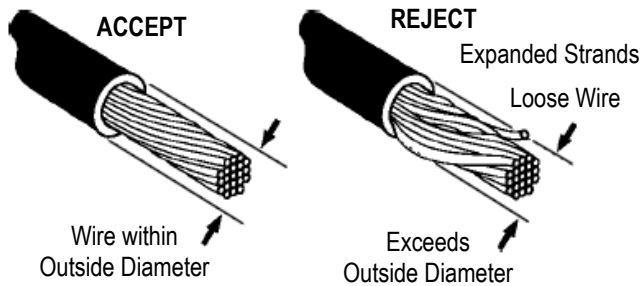

Check the insulation to ensure that there has been a nice clean cut. Wires with damaged insulation should not be used.

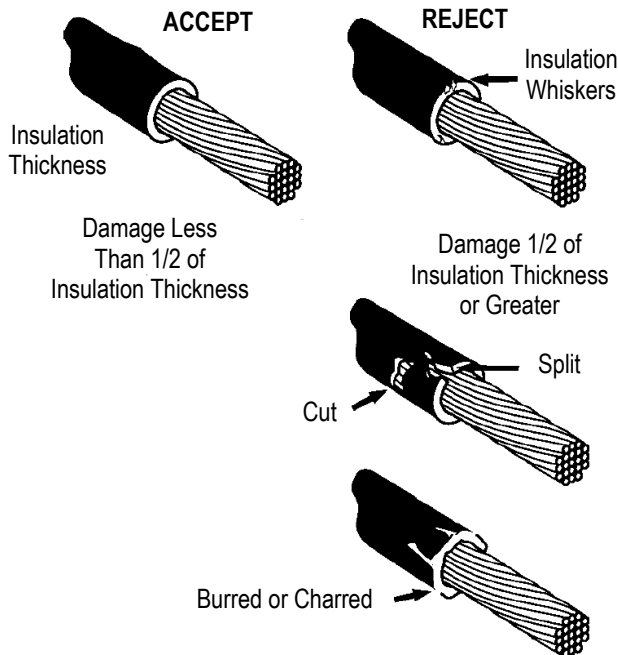

Check to see if the stripping tool or machine has cut or nicked any of the wires. If you see nicked wire you must cut and re-strip the wire before crimping to be sure that the amount of current that can be carried is not reduced.

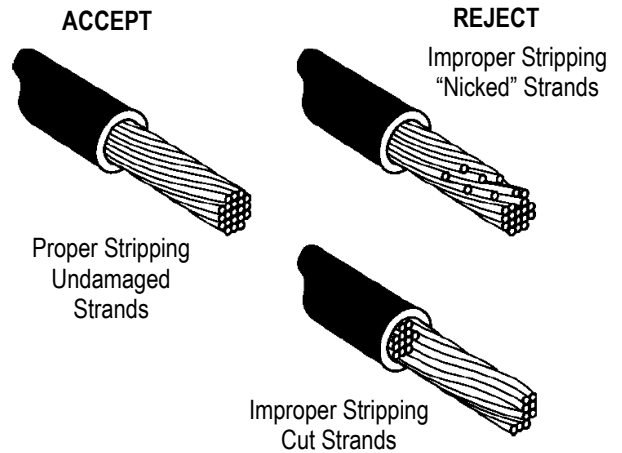

#### 6.2 Setup and Operation of a Press

1. Check that tooling is clean and not worn. If necessary, clean and replace worn tooling.
2. Disconnect power to the press and remove guarding devices.
3. Install the appropriate tooling into the press.
4. Load terminals into the tooling so that the first terminal is located over the anvil.
5. Manually cycle the press to help ensure a complete cycle can be made without interference. If it cannot, remove tooling and check press shut height. Go to procedure 3.
6. Check that the tooling is aligned. Check the impression on the bottom of the crimp that was made by the anvil tooling. Check that the extrusions and crimp form are centered. If not, align tooling and go to procedure 5.
7. Check that the terminal feed locates the next terminal over the center of the anvil tooling. If not, adjust terminal feed and the feed finger and go to procedure 5.
8. Re-install all safety devices that were removed during the set-up. **(Follow all safety requirements listed in individual press and/or tooling manuals.)**
9. Crimp sample terminals under power.
10. Evaluate cut-off tab length and conductor bell mouth. If adjustment is necessary, disconnect power to the press and remove guarding. Adjust

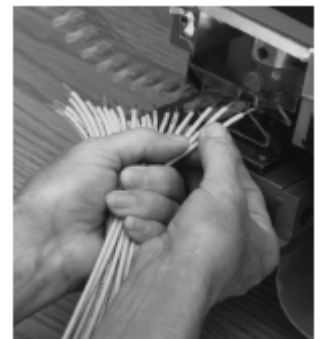



track position. Manually cycle the press and check the feed finger for feed location, go to procedure 7.

11. Evaluate conductor brush. If adjustment is necessary, disconnect power to the press and remove guarding. Adjust wire stop for bench applications or press position on automatic wire processing equipment. Go to procedure 8.
12. Evaluate insulation position. If necessary, adjust strip length, crimp new samples, and go to procedure 11.
13. Adjust insulation crimp height so the insulation crimp is not in contact with the wire insulation.
14. Crimp sample terminals.
15. Measure conductor crimp height (if applicable) and compare to specification. If necessary, disconnect power and remove guarding. Adjust conductor crimp height, install guards, connect power, and go to procedure 14.
16. Perform a pull force test.
17. Adjust insulation crimp.
18. Crimp sample terminals.
19. Evaluate insulation crimp. If necessary, disconnect power and remove guarding. Adjust insulation crimp height, install guards, connect power, and go to procedure 18.
20. Measure crimp height and compare to specification. If necessary, disconnect power and remove guarding. Adjust conductor crimp height, install guards, connect power, and go to procedure 18.
21. Document measurements.

### 6.3 Setup and Operation of a Hand Crimp Tool

1. Insure that the hand tool is designed to crimp the size wire and the proper terminal shown on the Hand Crimp Tool Specification sheet.

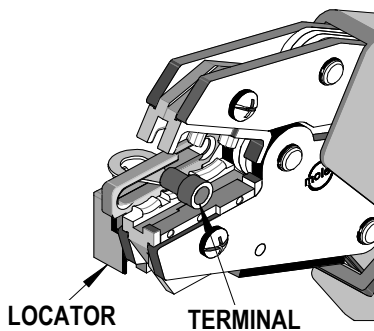
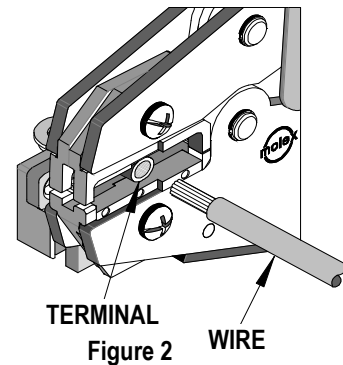

Figure 1

2. Strip the wire and make sure it is clear of any nicks or cuts. See Section "Preparing the Wire" above.

3. Place the terminal in the tool. Select the proper color-coded crimp nest.
4. If using a locator, lift the locator and insert the terminal in the proper nest with the barrel up and against the locator bar. Release the locator blade to hold the terminal in position. See Figure 1. Locator may be raised or lowered so terminal sits flat and straight in tool. The locator must be removed to run splices.
5. Insert the wire. See Figure 2.



6. Squeeze the handle. All production hand tools should have a built in full-cycle ratchet mechanism.
7. Inspect for proper crimp location. Check the Hand Crimp Tool Specification sheet that you are using for correct conductor crimp height.

### 6.4 Setup and Operation of a Air Powered Crimp Tool

1. Insure the Air Crimp Tool is designed to crimp the size wire and the proper terminal shown on the Air Crimp Tool Specification Sheet.
2. Strip the wire and make sure it is clear of any nicks or cuts. See Section "Preparing the Wire" above.
3. Place the wire into the terminal. Select the proper color-coded crimp nest.

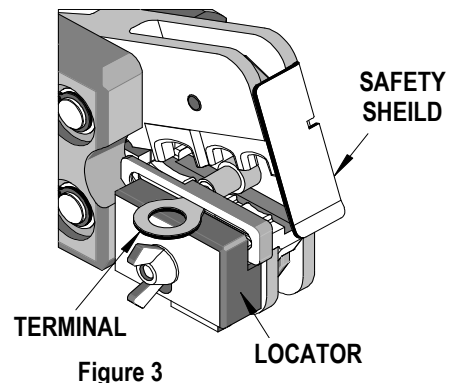

Figure 3

4. If using a locator, lift the locator and insert the terminal with the wire in the proper nest with the barrel up and against the locator bar. Release the locator blade to hold the terminal in position. See Figure 3. Locator may be raised or lowered so terminal sits flat and straight in tool. The locator must be removed to run splices.
5. Push on the wire to assure it is still fully seated in the terminal. Cycle the tool. See Figure 4.

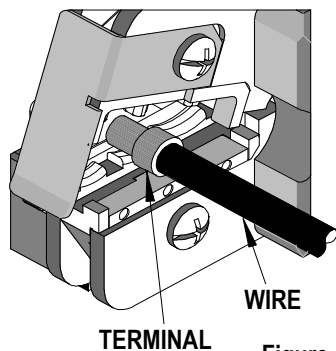

Figure 4

6. Inspect for proper crimp location. Check the Air Powered Crimp Hand Tool Specification Sheet that you are using for correct conductor crimp height

**Caution:**  
 Never operate this tool without the supplied safety shield in place. Never place fingers in the tool nests.

**Note:** Whenever crimping without the locator, make sure the seam of the barrel is oriented up or down in the tool as this will provide higher pull force values.

### 6.5 Crimping Dies

The Molex product line includes seven types of dies for different terminals:

- Two piece INDENTOR CRIMP, VersaKrimp™
- Two piece CONFINED CRIMP, Krimptite™ and VersaKrimp™
- Two piece CONFINED CRIMP, InsulKrimp™ and AviKrimp™
- Two piece F TYPE CRIMP, Krimptite™ and VersaKrimp™
- Four piece F TYPE CRIMP, VibraKrimp™

Four piece CONFINED CRIMP, InsulKrimp™ and AviKrimp™.  
 Bottom INDENTOR CRIMP, 8 and 6 AWG VersaKrimp™.

- The Indentor crimp consists of a holding nest and indentor ram to deform the barrel. The advantage of this configuration is that while it covers a broad range of wire sizes, it is still easy to design and inexpensive to manufacture.

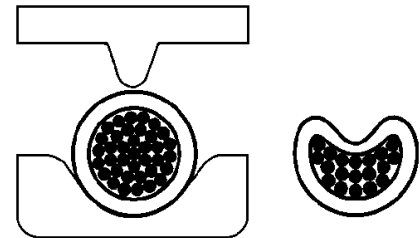

- The F crimp is used to close the barrel and confine the individual strands. The overall quality is excellent.

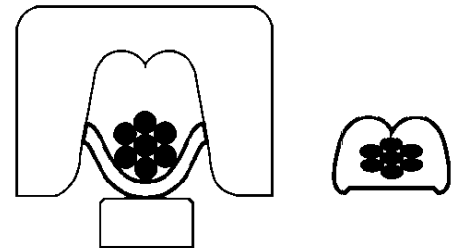

- The Confined crimp gives the best overall crimp. It is in the shape of a hexagon, an enclosed "C", or a confined quad. The advantages of all three crimps are uniformity and compression of individual strands and uniform outer appearance.

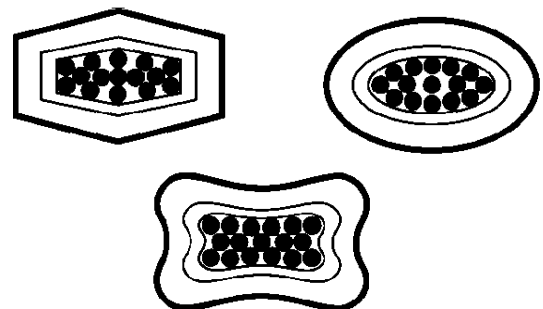

Molex provides a complete line of fully automatic wire processing machines, semi-automatic and manual wire crimping tools. Each system is tailored to our customer's individual needs by using support equipment, and can be adapted to wire processing equipment offered by manufacturers

such as ARTOS, KOMAX, and others. This Manual shows the basics of Manual and Semi-Automatic equipment.

## SECTION 7

### QUALITY CRIMPS

Quality is something that must be measured by some set of criteria. Four major agencies give test criteria for quality of solderless terminals. They are:

- U.L. (Underwriters Laboratories)
- CSA (Canadian Standard Association)
- NEMA (National Electronic Manufacturers Association)
- Federal Government Spec - Mil-T-7928

In all of the above standards specific reference is made to the following areas:

- Copper or brass quality specifications
- Tin-plating specs type and thickness
- Smoothness of edges and lack of burrs
- Firmness of fit between metal and insulation

Then there is a whole series of tests to be performed on the crimp area after the crimp is made:

- Tensile test
- Dielectric withstand
- Salt spray
- Vibration
- Heat rise

The most widely used field test for testing the quality of the crimp is the pull test, or tensile test.

The two most widely used measurements are the U.L. and Military Tensile values. See Section 8. Note that the Military pull force is higher than the U.L.

### 7.1 Visual Inspection of **OPEN BARREL** Crimps

#### ▪ Insulation Not Damaged

1. Crimp the insulation just enough (may have a slight indentation to hold the wire in place). If the insulation has been pierced or crushed, the wires inside may have been damaged also.
2. Be sure that the conductor insulation has not been pierced or crushed by the crimp.

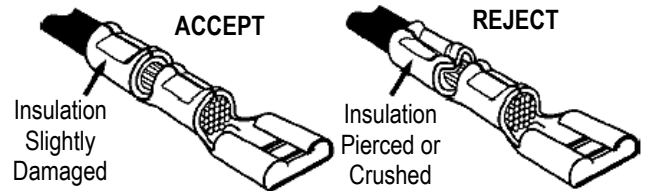

#### ▪ Insulation Support Crimp

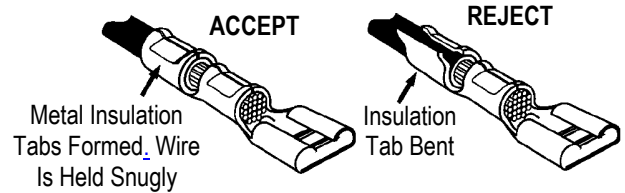

1. Be sure that the insulation barrel tabs are not bent.
2. Form the tabs properly.
3. If one of the tabs is bent, the insulation crimp will not be strong enough to provide the needed stress relief.

#### ▪ Wire Visible

1. Be sure that both the wire and the insulation are visible in the window.
2. If only the insulation is visible, you may have crimp insulation in the conductor barrel.
3. If only the bare wire is visible, you cannot assume that the insulation has been properly crimped.

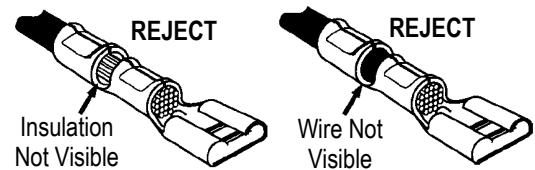
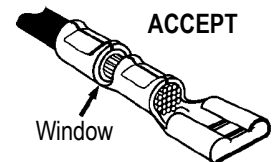

4. If there is no insulation support crimp, be sure that the length of the wire visible behind the conductor crimp is not greater than the diameter of the insulation. If the length of the wire visible exceeds the diameter of the insulation, the terminal could cause a short circuit.

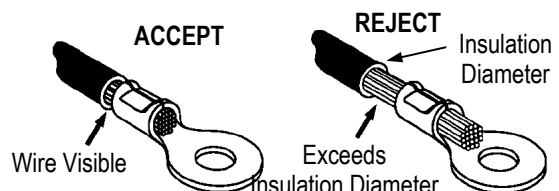

■ **Good Bell Mouth Present**

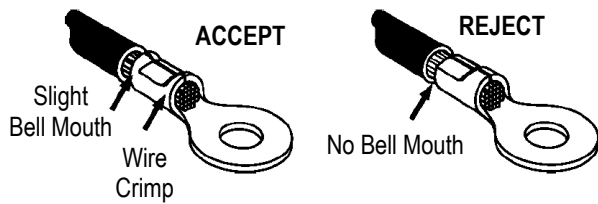

1. Be sure that a good bell mouth is present in the wire barrel.
2. If no bell is present, the sharp edge of the wire barrel may cut or nick the wires.

■ **No Wire Strands in the Contact Area**

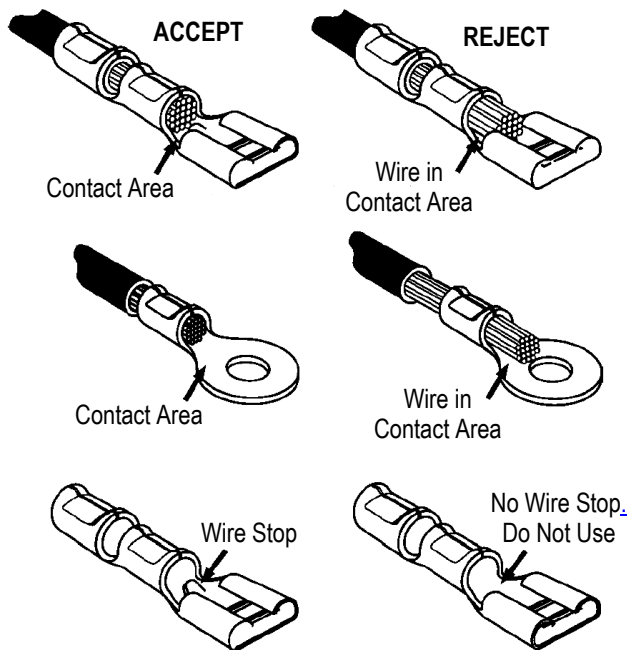

1. Be sure that no wire strands extend into the contact area of the lug or terminal.
2. If the wire strands are in the contact area, they will interfere when the terminal is connected.

■ **No Strands Sticking Out (Strand Fold Back)**

1. Be sure that all of the wire strands are twisted together, and are equal to the size they were before being stripped.
2. If the strands are not together, or if one is left sticking out, your wire mass is reduced and can cause both electrical and mechanical problems.

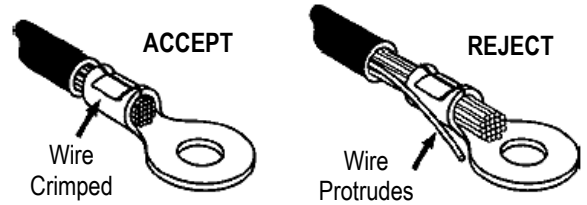

■ **Wire Extension**

1. Be sure that the wires extend not more than 1/32" (1mm) past the end of the barrel. If the wires are not flush or greater, you will not be able to see if the crimp is complete and correct.

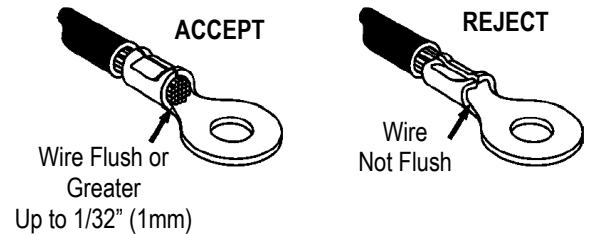

■ **No Damage to the Contact Area**

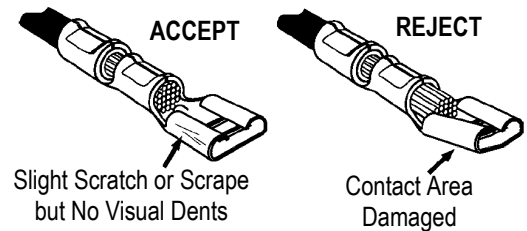

1. Be sure that the contact area is not dented or crushed.
2. If it is dented or crushed (slight scratch or scrape is permissible), the connection between the terminal and another component cannot be made properly.

7.2 Visual Inspection of **CLOSED BARREL** Crimp

■ **Wire Visible**

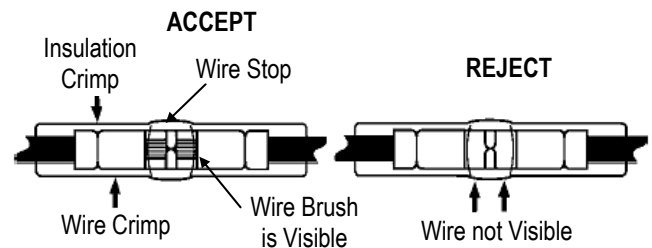

1. Be sure that the wire is visible in the inspection window so that there is evidence of a good crimp. See Butt Connector above.

■ **Crimp to be Centered**

1. On all crimped terminals, the conductor crimp should be centered on the conductor barrel. This insures even pressure on the entire length of the barrel.

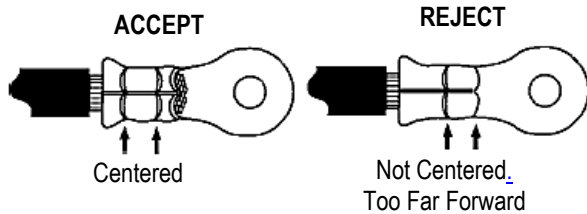

■ **Good Bell Mouth Present**

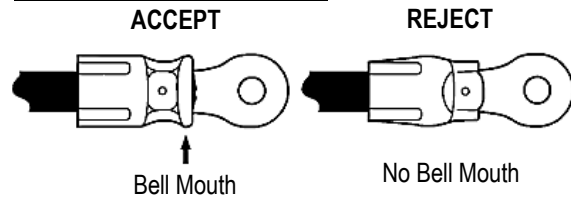

1. Be sure that a good bell mouth is present on the wire barrel.

■ **No Wire Strands in the Contact Area**

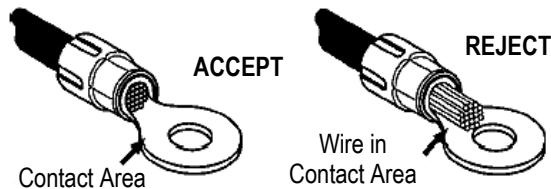

1. Be sure that wire strands do not exceed into the tongue area of the lug or terminal.
2. If the wire strands are in the contact area, they will interfere when the terminal is connected.

■ **Wire Flush or Greater**

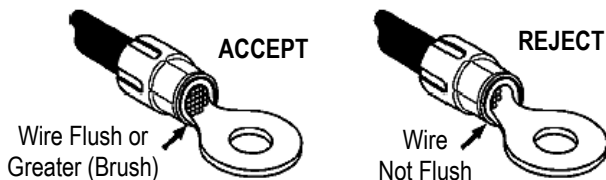

1. Be sure that the wires are either flush with the end of the conductor barrel or extend past the barrel.
2. This “brush” extension should be approximately 1/32” (1mm).
3. If the wires are not flush or greater, you will not be able to see if the crimp is complete.

■ **Wire Size (AWG) Requirements**

1. To achieve a quality crimp be sure to follow the proper insulation crimp for different wire sizes.

Wire sizes of 8 AWG and larger do not require an insulation crimp.

**ACCEPT**

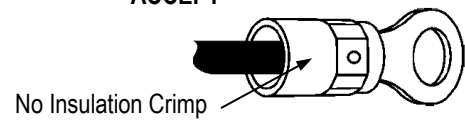

Wire sizes 18 thru 10 AWG require an insulation crimp to securely hold the wire insulation crimp.

**PLASTIC INSULATION CRIMP**

**REJECT**

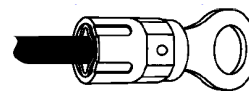

Insulation Deformed  
Wire Can Move  
In Insulation Crimp

**REJECT**

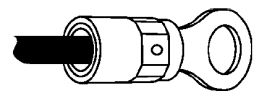

No Insulation  
Crimp

**METAL INSULATION CRIMP**

**ACCEPT**

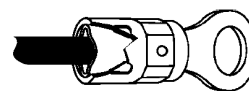

Insulation Deformed  
Wire Should Not Move  
In Insulation Crimp

**REJECT**

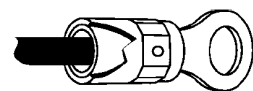

No Insulation  
Crimp

**ACCEPT**

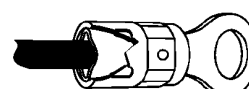

Insulation Indent  
Formed-Wire Secure  
In Insulation Crimp

**REJECT**

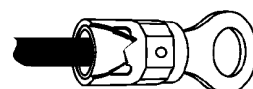

Insulation Indent Not  
Formed-Wire Moves  
In Insulation Crimp

■ **Insulation Support Crimp**

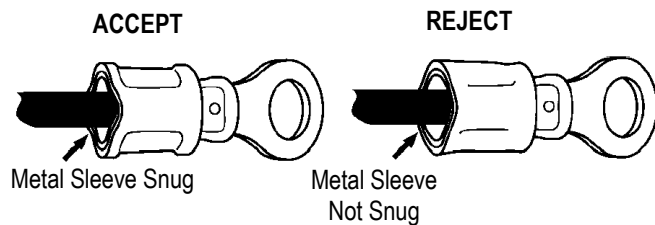

1. On closed barrel terminals that have a secondary metal sleeve (AviKrimp™), the metal sleeve should be formed snugly around the wire.

## SECTION 8

### IMPORTANCE OF PROPER CRIMPING

Once the correct terminal is selected, proper attachment to the wire is critical. One indication of the importance of proper crimping is evidenced in a study for the Space Shuttle Program that traced 28% of all defects to improperly assembled wiring and connectors. Mechanical as well as electrical connections are important - The result of a properly crimped joint is a reliable mechanical and electrical connection.

The mechanical connection is the crimping of the terminal to the conductor. The desired result is sufficient force on the outside of the barrel to tightly form it around the conductor. It must be secure enough not to vibrate loose or to be pulled off through normal use.

The electrical characteristics are just as important. The major concern is the amount of electrical resistance caused by the mechanical joint. The electrical resistance will determine the crimped joint's ability to conduct current

#### 8.1 Conditions

To achieve a positive relationship between the mechanical and electrical connection in the crimped joint, the following conditions are required:

1. The terminal must be of sufficient cross section size and conductive material that it is as good an electrical conductor as the wire.
2. The surfaces of the wire and terminal that will be pressed into contact in the crimp must be clean and free of heavy, non-conductive films such as oxides, sulfides, and similar substances.

Some reasons for failure of crimped joints to meet minimum tensile requirements include nicked wires, nicked or ruptured strands, strand turn back at crimp joint, and ruptured wires outside of the crimped terminal. To avoid these problems, use the correct size wire for the barrel, prepare your wire carefully, and use the proper crimping tool.

## 8.2 Testing

### Mechanical

The tensile test or pull test is a means of evaluating the mechanical properties of the crimped connection. The chart on this page shows the UL and Military Specifications (MIL-T-7928) for various wire sizes. The tensile strength is shown in lbf (pound-force), it indicates the minimum acceptable force to break or separate a terminal from the conductor.

When the crimp is made, there must be enough pressure applied so that the oxides that may build up on the stripped conductor and the tin plating on the inside of the terminal barrel are broken down and there is good metal-to-metal contact. If this situation does not occur, the resulting crimp will have unacceptably high resistance.

Tensile Strength in Pound-force				
Wire Size (AWG or MCM)	*UL-486A	*UL-486-C	*UL-310	*Military Class 2
26	3	N/A	N/A	7
24	5	N/A	N/A	10
22	8	8	8	15
20	13	10	13	19
18	20	10	20	38
16	30	15	30	50
14	50	25	50	70
12	70	35	70	110
10	80	40	80	150
8	90	45	N/A	225
6	100	50	N/A	300
4	140	N/A	N/A	400
2	180	N/A	N/A	550
1	200	N/A	N/A	650
1/0	250	N/A	N/A	700
2/0	300	N/A	N/A	750
3/0	350	N/A	N/A	825
4/0	450	N/A	N/A	875
250 MCM	500	N/A	N/A	1000
300 MCM	550	N/A	N/A	1120
350 MCM	600	N/A	N/A	1125

\*UL - 486 A - Terminals (Copper conductors only)

\*UL - 486 C - Butt Splices, Parallel Splices, Closed End Connectors, and Wire Nuts

\*UL - 310 - Quick Disconnects, Flag and Couplers

\*Military Class 2- Military Approved Terminals only as listed



### Dielectric Testing

(The term “dielectric” refers to an insulator.)

Some terminals are covered with insulation so that electrical contact can be made only where it is desirable. The crimp is made through (on) this insulation, which is compressed and extruded due to the pressure of the crimping dies. Obviously, not all insulation materials can withstand this treatment and even with the strongest materials, the crimp must be correctly designed so as not to rupture the insulation.

Dielectric tests are made on insulated terminals after crimping to determine that the crimp process is not rupturing the insulation or thinning it out so that it will not withstand impressed voltages. The test is made by impressing a voltage between the wire to which the terminal is crimped and conductive materials contacting the terminal insulation.

The voltage is gradually increased until the requirements are reached or until a breakdown occurs which means the insulation breaks. Depending on the use and the specifying agency, dielectric withstanding requirements normally range from 1500 to 8000 volts, resulting in a 300 to 600 volt rating of the terminal.

### 8.3 Final Tensile Value

The type of die affects the final tensile value in several ways. See Crimping Dies, Section 6.5.

If the die (as in the indenter type) does not indent far enough, a void may be created in the compression joint permitting the individual strands to shift, thus loosening the connection. Further, the air space (void) acts as an electrical insulator.

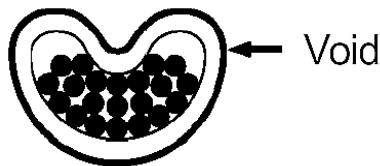

If the die presses too tightly the individual strands can be squeezed and elongated. This can cause a weak point in the conductor, cause the wire to break at a lower than allowable tensile strength, and/or create a heat rise across the joint because of lower cross-section and increased resistance.

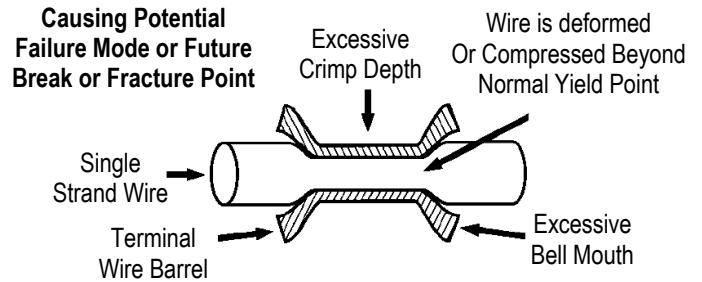

Another way to cause tensile failure is not compressing the barrel enough to hold the conductor securely. Molex crimp tools are designed to eliminate these problems.

### 8.4 Electrical Resistance

The electrical resistance across the crimp is compared to the resistance of an equal length of wire, and expressed as relative resistance for a particular wire size.

Relative resistance of the crimp to the wire is given by the formula below:

$$\text{Relative resistance} = \frac{R_C}{R_W}$$

Where:

$R_C$  = Resistance over crimp

$R_W$  = Resistance of wire

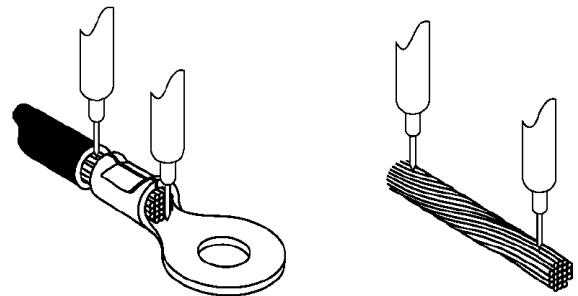

Relative resistance values of less than 1.0 denote a crimped joint with less resistance than the wire; values more than 1.0 indicate greater resistance than the wire. Usually it is easier to measure the voltage drop across the crimped joint. Many specifications state the requirements in terms of voltage drop at a specified current. Voltage drop is the more commonly used term in the industry. If the resistance value is desired, it may be calculated from Ohm's Law:

$$R = \frac{E}{I}$$

Where:

$R$  is the resistance (in milliohms)

$E$  is the voltage drop (in millivolts)

$I$  is the current flowing (in amperes)

Crimp voltage drop and resistance values are quite small and are expressed in terms of millivolts (.001 volts) and milliohms (.001 ohms).

A crimp joint of poor quality could be caused by several factors. It is indicated by increased resistance, which cause increase in voltage drop value.

For example, the presence of air pockets or voids in the crimped joint will cause a higher resistance (smaller area of contact between terminal and wire). Increased resistance results in a higher voltage drop and a temperature rise, which in turn increases the corrosion rate and further increases the resistance.

A crimped joint that has been over-crimped and the conductor (wire) elongated out of shape could cut the circular area of the conductor and cause a greater resistance at this weakened point.

## 8.5 Crimp Joints

A finely stranded wire (large number of small diameter strands) usually improves crimped joint performance. A wire composed of a few strands of larger size will tend to act as a solid wire in the crimp. Some stranded wire crimp configurations are not satisfactory for solid wire. More deformation must be imposed in order to form wire and barrel into a solid mass. On the other hand, finer strands will more readily fill the inside

corners of the crimp shape and more evenly distribute the forces of the crimp.

Brazed barrel terminals usually give higher tensile test than the non-brazed (for specific values, tensile tests must be performed on each terminal).

### Annealing

When the metal part of a solderless terminal is stamped on a stamping press; the strip of metal material is repeatedly hit in the stamping process.

These terminals are made on progressive dies.

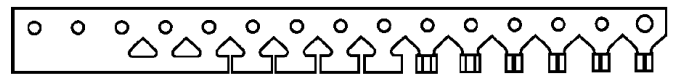

This repeated hitting causes the metal (usually copper) to become work hardened. Copper gives its best mechanical and electrical characteristics when it is in its original (not work hardened) state.

In order to return the work hardened copper to its normal soft and malleable state, it must be annealed. Annealing is accomplished by heating the metal (copper) terminal in a furnace, and then cooling it slowly. This process restores the copper to its original state.

How does annealing (or lack of) affect the crimp barrel and quality of a solderless terminal?

When a work-hardened terminal is crimped, it does not form around the wire in a uniform fashion, thus giving sharp angles, which allows for voids. The annealed barrel can be easily formed, giving uniform pressure on the wire and thus a superior crimp.

**SECTION 9**

**MISCELLANEOUS**

AWG-CMA Table	
Terminal Size /AWG	CMA Range
26-22	202-810
24-20	320-1,020
22-18	509-2,600
22-16	509-3,260
16-14	2,050-5,180
14-12	3,260-8,213
12-10	5,180-13,100
8	13,100-20,800
6	20,800-33,100
4	33,100-52,600
2	52,600-83,700
1/0	83,700-119,500
2/0	119,500-150,500
3/0	150,500-190,000
4/0	190,000-231,000

**Technical Wire Information**

CMA — Circular Mil Area. Circular Mil is a unit of area equal to that of a circle whose diameter is one Mil.

MIL — One mil equals .001 inches.

.001" = 1 mil

.030" = 30 mils

.125" = 125 mils

Changing Inches to Mils

1. Multiply inches by 1000 or,
2. Move decimal point 3 places to right or,
3. Change terminology, i.e. 0.032 in. = 32 thousandths or 32 mils.

Computation of CMA

Round Solid Conductor:

Change diameter from inches to mils, and then multiply the diameter "D" in mils by itself.

$CMA = D \text{ mils} \times D \text{ mils}$

Stranded Conductor:

Find CMA of a single strand and multiply the result by the total number of strands.

$CMA = (D \times D) \times \text{Number of Strands of one Strand}$

**Americas Headquarters**  
 Lisle, Illinois 60532 U.S.A.  
 1-800-78MOLEX  
 amerinfo@molex.com

**Far East North Headquarters**  
 Yamato, Kanagawa, Japan  
 81-462-65-2324  
 feninfo@molex.com

**Far East South Headquarters**  
 Jurong, Singapore  
 65-6-268-6868  
 fesinfo@molex.com

**European Headquarters**  
 Munich, Germany  
 49-89-413092-0  
 eurinfo@molex.com

**Corporate Headquarters**  
 2222 Wellington Ct.  
 Lisle, IL 60532 U.S.A.  
 630-969-4550  
 Fax: 630-969-1352

Visit our Web site at <http://www.molex.com>