

Handling manual for hand crimping tool

TC-QR/ P1-PC1A
TC-QR/ P1-PC1B
TC-QR/ P1-SC1A
TC-QR/ P1-SC1B
TC-QR/ P1-PC2A
TC-QR/ P1-PC2B
TC-QR/ P1-SC2A
TC-QR/ P1-SC2B

DRAWN	CHECKED	APPROVED
<i>S. Sato</i>	<i>T. Watanabe</i>	<i>H. Miwa</i>
'96.11.28	'96.12.2	96.12.2

HIROSE ELECTRIC CO., LTD.

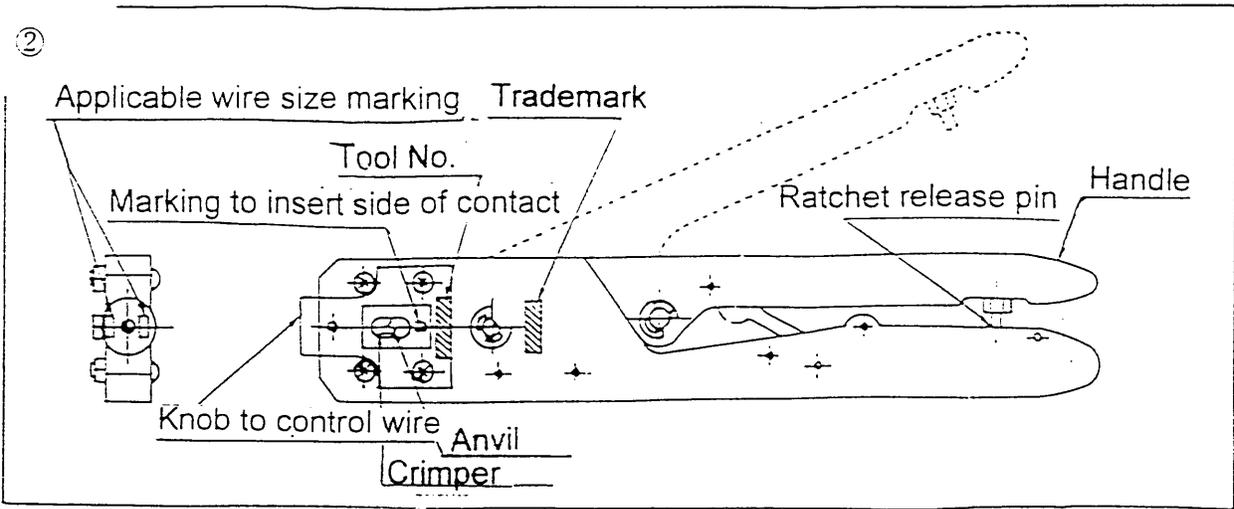

[Fig- 2]

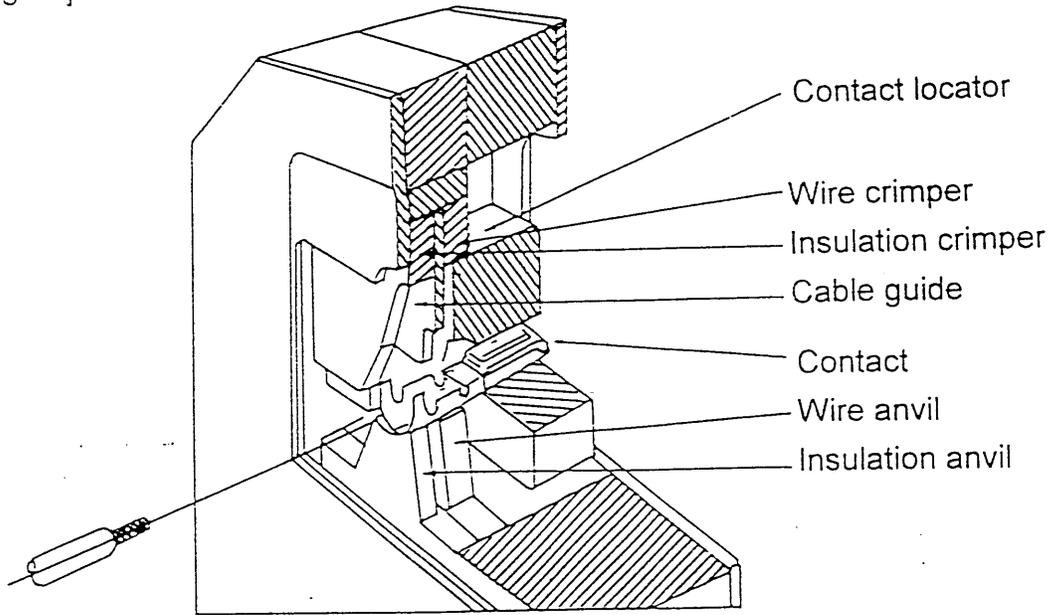

• Parts name of contact and strip length of wire insulator

[Fig-3]

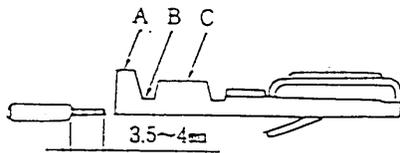

(Common in each contact Ex. QR/ P1-PC1B-121)

A: Insulation barrel

B: Barrel separation slot

C: Wire barrel

• Crimping procedure

Crimping to be performed under the following procedure.

- ① Open the handle to the full extent. (First of all, close the handle, hold the handle until ratchet becomes to be released by ratchet release pin and loose your hold to open the handle naturally.) . . . See Fig- 1.
- ② For the knob to control wire , adjust the wire marking to be at contact insertion side with pushing the knob slightly. . . . See Fig- 1.
- ③ Push the contact perfectly until the contact is stooped by contact locator. (In this time, the end face of insulation barrel and anvil comes to approximately the same

Handling manual for hand crimping tool

This tool is applicable for the small-kit production, repair to ensure safety and sample manufacturing. Precision, certain and robust ratchet mechanism doesn't need strong grip strength, have the crimper and anvil perfectly closed and not opened the handle unless perfectly applied sufficient crimp force; enabled excellent usability. Proceed workings corresponding to this handling manual for hand crimping tool to gain perfect level of crimping.

- Applicable contact and wire

[Table- 1]

Tool	Applicable contact	Wire size			Configuration
		AWG No.	Nominal cross-section (mm ²)	Insulator outer diameter (mm)	
TC-QR/ P1-PC1B	QR/ P1-PC1B-121 ()	14 to 16	1.31 to 2.08	3.2 to 3.6	See Fig- 1, ②
TC-QR/ P1-SC1B	QR/ P1-SC1B-121 ()				
TC-QR/ P1-PC1A	QR/ P1-PC1A-111 ()	18 to 24	0.20 to 0.82	1.5 to 2.2	
TC-QR/ P1-SC1A	QR/ P1-SC1A-111 ()				
TC-QR/ P1-PC2B	QR/ P1-PC2B-121 ()	20 to 24	0.20 to 0.52	1.5 to 1.9	
TC-QR/ P1-SC2B	QR/ P1-SC2B-121 ()				
TC-QR/ P1-PC2A	QR/ P1-PC2A-111 ()	24 to 28	0.08 to 0.20	0.9 to 1.5	See Fig- 1, ①
TC-QR/ P1-SC2A	QR/ P1-SC2A-111 ()				

- Parts name of tool

[Fig- 1]

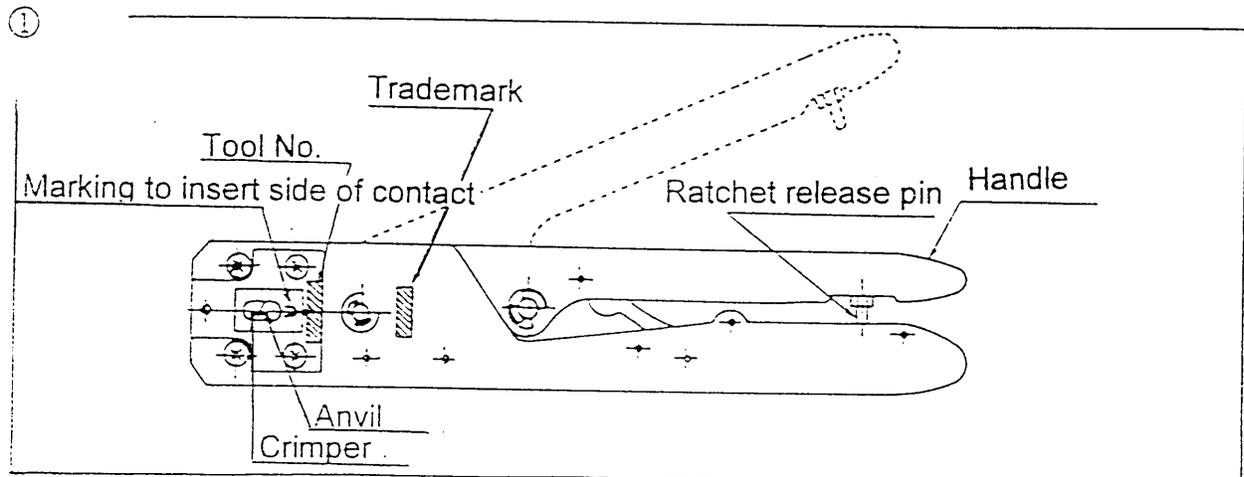

plane.) . . . See Fig- 2.

- ④ Insert the wire of its insulator stripped by the specified length (See Fig- 3) not to entwine wires each other into wire guide until the end face of insulator strikes the guide. . . . See Fig- 2.
- ⑤ Hold the handle to close until the ratchet is released by ratchet release pin, then loose your hand to open the handle until it stops naturally. Crimping is completed. . . . See Fig- 1.
- ⑥ Pick the completely crimped contact out slightly from the tool with handing wires. (In this case, not to strike and deform contact on the locator and crimper.)
After completion of crimping, check the contact whether it was appropriately crimped or not.

[Fig- 4]

Conforming

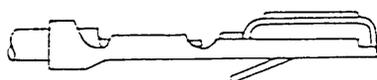

[Fig- 5]

Defective (Ex.)

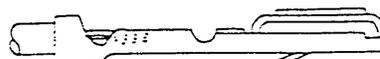

Poor insertion of wire



Too extent insertion of wire

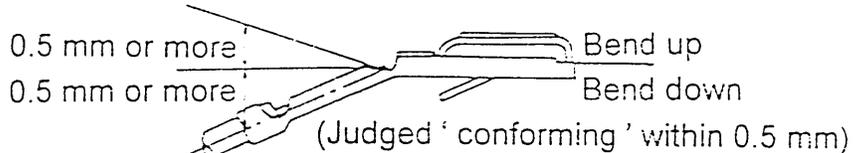

• Caution for handling

1. Do not apply impact on this tool as hitting or falling down from high position.
2. Do not use this tool to crimp something other than applicable contact and wire shown in Table- 1.
3. Handle does not open before the release of ratchet. Do not proceed working with the strong hand.
4. This too is not applicable for other than crimping. Avoid non-equipped contact crimping as much as you can.
5. If you have trouble on this tool, Do not take to pieces, but call up to inform the detail of its condition.
6. After crimping, take off dust and foreign matters with soft clothes, close the handle not to be inserted into crimp dais and then store in the dry place.
7. Looseness of ratchet release pin will bring crimp height error, call up to inform the details of its condition.

• Function test of crimping tool

When the use extends over a long period of time, check the required dimension for wire barrel is satisfied. If the dimension of each crimp height is between max. and min., there is no problem. Check the crimp strength, too.

[Fig- 6]

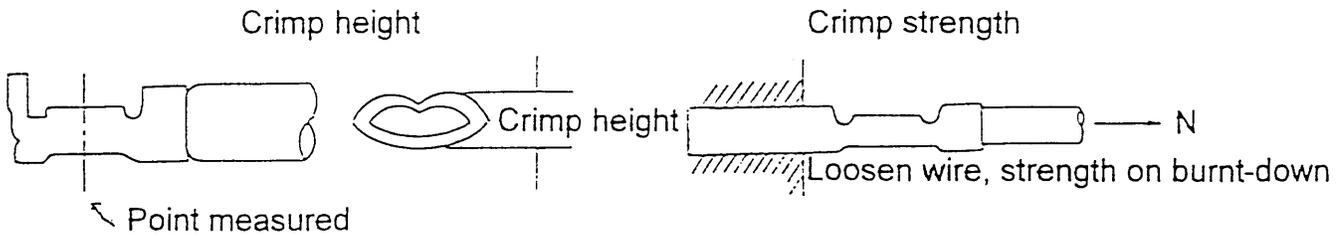

Wire size (AWG) Item	Crimp height (mm)								
	Crimp contact	14	16	18	20	22	24	26	28
QR/ P1- PC1B	Max	1.48	1.37	-	-	-	-	-	-
	SC1B	Min	1.36	1.27	-	-	-	-	-
QR/ P1- PC1A	Max	-	-	1.16	1.08	0.92	0.90	-	-
	SC1A	Min	-	-	1.02	0.94	0.84	0.82	-
QR/ P1- PC2B	Max	-	-	-	1.04	0.96	0.92	-	-
	SC2B	Min	-	-	-	0.96	0.88	0.84	-
QR/ P1- PC2A	Max	-	-	-	-	-	0.79	0.76	0.75
	SC2A	Min	-	-	-	-	0.71	0.68	0.67
Crimp strength (N)		147 or more	147 or more	127.4 or more	88.2 or more	52.9 or more	35.3 or more	23.6 or more	15.7 or more

Handling of crimping contact and caution for the wiring

1. Caution for handling of crimping contact

- 1) Do not touch on contact more than needs. (It will become the cause of deformation and corrosion).
- 2) When you touch contact, pull gloves on your hands possibly for the protection of corrosion.
- 3) Put contact in the clean case, not to be scattered on the table during working.
- 4) Do not handle contact rudely as putting heavies on or dropping down from table.
- 5) As for the entwined contacts, not to be pulled by the strong hand, but pick those apart carefully not to be deformed.
- 6) When you hold contact, Do not hold the lance where is easy to be deformed possibly. In the case of holding contact, not to apply too much force.
- 7) Contact itself is easy to be deformed, so pay attention to another other than those mentioned above.

2 Caution for wiring

- 1) Strip length of wire insulator is different depending on each contact, proceed the working in accordance with handling manual for tool.
- 2) Be careful not to damage the wire and partial defect state of stranded wire on stripping of the wire insulator.
- 3) Wires to be protruded out by 100 mm or more form insulator for the easy handling.

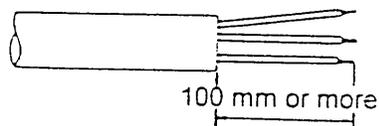

- 4) Cut the wire considering extra length for crimp failure.
- 5) Insert the contact along the contact locator (holder) gently until it stops. Do not push the contact by the strong hand to be derailed and stop in the middle of the working.
- 6) Do not have the tool upside down or inclined for fear of coming out from appropriate position of contact inserted into the tool.
- 7) Adjust the position of contact and wire on the basis of wire guide.

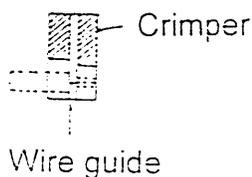

- 8) Do not return the handle of crimping tool during the working because the handle has mechanism not to be opened unless it is appropriately crimped.

In spite of crimping error, proceed the working until the ratchet is released and

then pick out the contact and dispose. In the case of handle stopping before the release of ratchet, call up with it being itself.

- 9) After the completion of crimping, check the contact whether it is appropriately crimped or not.
 - a. With or without contact deformation



Bending, twisting and scrapped lance

- b. Insulator is inserted into wire barrel or not.



- c. Insulator is crimped on insulation barrel or not



- d. Wires are protruded out from wire barrel



3. Caution for the inserting into housing

- 1) Hold the wire at the position far from contact by 10 mm and insert.

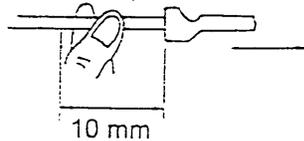

- 2) Insert the contact into housing flatly.

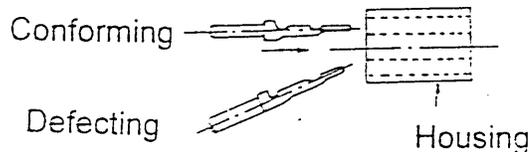

- 3) Do not insert the contact into housing with the strong hand with wrenching.
- 4) Do not hold too strong to deform the contact portion and lance.
- 5) Insert the contact to the full extent until the lance hangs. When the lance is hanged appropriately, you can hear the click.
- 6) Check the lance to be hanged perfectly with pulling the wires gently and shaking.
- 7) In the case of picking out the contact for the error wiring, not to pick the contact out by the strong hand but by our tool specified.

Contact picking out procedure

When you pick contact out from housing for the error insertion or circuit change, working to be proceeded as follows.

Fig-7

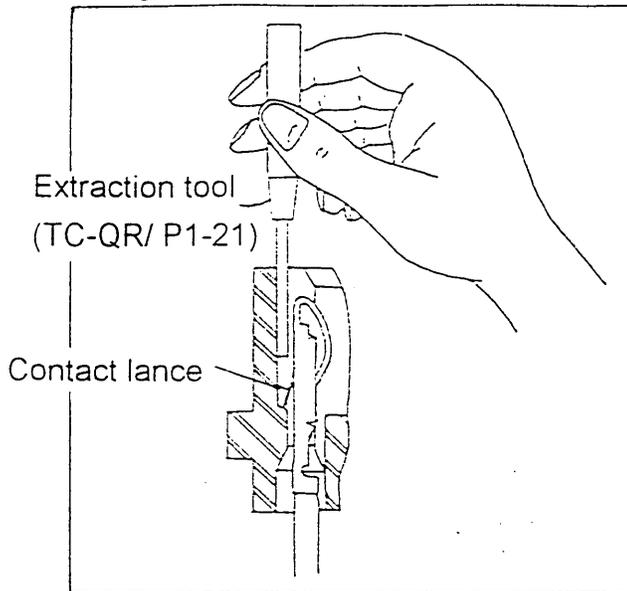
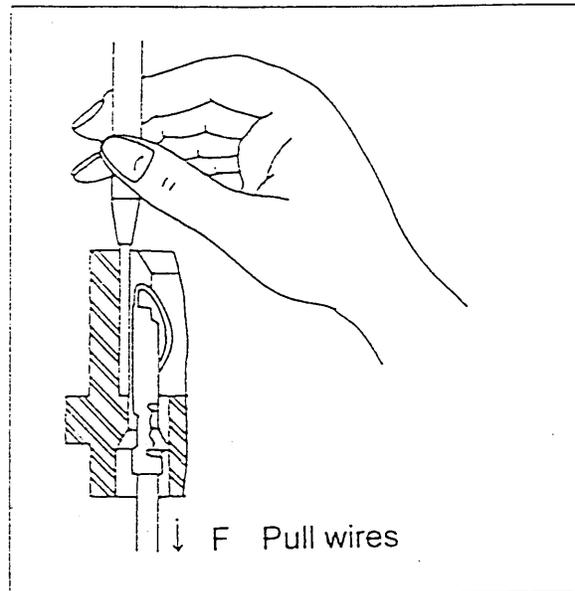

Fig-8



Hold the contact extraction tool as Fig- 7, insert the tool into gap between housing and contact.

Push the tool into housing, you can hear the click when the tool strikes the way and then pick the contact out with pulling the wires.

Though illustration of female housing is shown, male housing to be done in the same way.

Contact extraction tool, TC-QR/ P1-21 to be applied.

For the re-insertion of contact picked out once, perform the working after repairing of lance height to be the same with that of new ones (See figures shown below)

Contact	Lance Height (mm)
QR/ P1-PC1B-121 ()	
QR/ P1-PC1A-111 ()	
QR/ P1-PC2B-121 ()	
QR/ P1-PC1A-111 ()	
QR/ P1-SC1B-121 ()	
QR/ P1-SC1A-111 ()	
QR/ P1-SC1B-121 ()	
QR/ P1-SC1A-111 ()	

4. Caution for wire tying and others

1) Do not apply force on the contact on the wire tying.

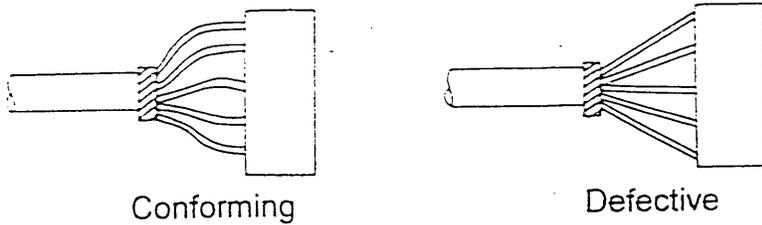

2) When tying both ends of cable, do not apply force on the contact already wired.

Example of defect

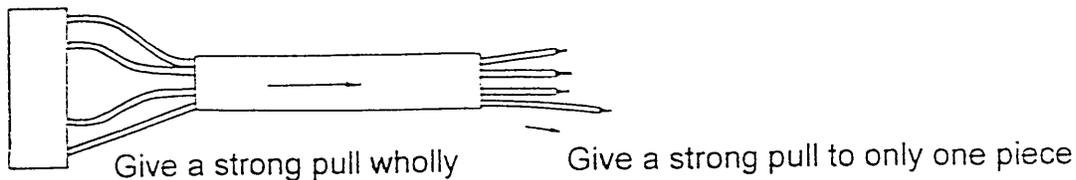

3) Check wire size perfectly wired and continuity after insertion of partner connector or PC board through the terminal at partner side.

Do not insert the checker contact directly into contact portion of terminal and lance.

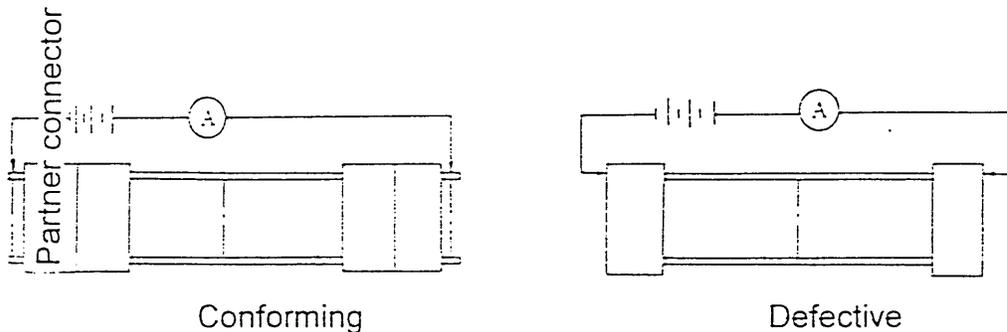

4) Do not insert something other than partner connector into contact portion of terminal during the electrical inspection and others.

5) In the case of no immediate insertion of crimped contact into housing, pay attention to the crimped contact in the same way of pre-crimp contact.