

PROPER USE GUIDELINES

Cumulative Trauma Disorders can result from the prolonged use of manually powered hand tools. AMP hand tools are intended for occasional use and low volume applications. AMP offers a wide selection of powered application equipment for extended-use, production operations.

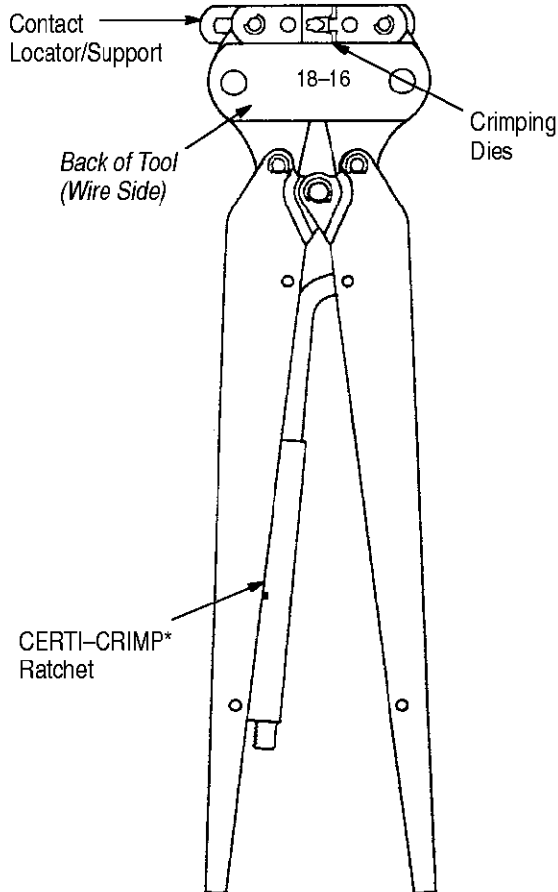

Figure 1

1. INTRODUCTION

AMP* Hand Crimping Tool 90136-1 (see Figure 1) is designed to crimp Type II pin and socket contacts shown in Figure 2 onto stranded copper wire sizes 18 through 16 AWG with an insulation diameter range of 2.03 to 2.67 mm [.080 to .105 in.]. Read these instructions thoroughly before using the tool.

NOTE

Dimensions in this instruction sheet are in millimeters [with inches in brackets]. Figures are not drawn to scale.

Reasons for reissue of this instruction sheet are provided in Section 6, REVISION SUMMARY.

2. DESCRIPTION

The tool features two sets of crimping dies, contact locator/support, and CERTI-CRIMP ratchet.

One die set crimps the wire barrel of the contact; and the other set crimps the insulation barrel. Both crimps are simultaneously accomplished with one operating cycle of the tool.

The contact locator/support aids in positioning the contact between the crimping dies, and prevents the contact from bending during the crimping procedure. The CERTI-CRIMP ratchet ensures full crimping of the contact. Once engaged, the ratchet will not release until the handles have FULLY closed.

CAUTION

The crimping dies bottom before the ratchet releases. This feature ensures maximum electrical and tensile performance of the crimp. Do NOT re-adjust the ratchet.

3. CRIMPING PROCEDURE

NOTE

The hand tool is coated with a preservative to prevent rust or corrosion. Wipe this preservative from the tool, particularly from the crimping area, before using the tool.

Refer to Figure 2, and select wire of the specified size and insulation diameter. Strip the wire to the length indicated—do NOT cut or nick the wire strands.

Typical Type II Contacts

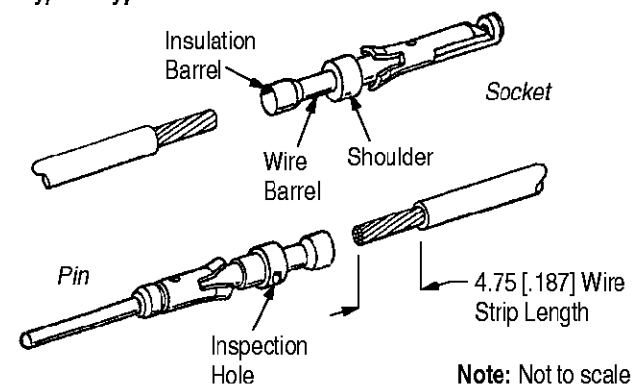

WIRE SIZE RANGE (AWG)	WIRE INSUL DIA RANGE	PIN	SOCKET
18-16	2.03-2.67 [.080-.105]	202507-[]	202508-[]

Figure 2

The following procedure applies to both socket and pin contacts. Refer to Figure 3, and proceed as follows:

1. Hold tool so that BACK of tool (wire side) is facing you.
2. Open the tool crimping dies by squeezing the handles until the ratchet releases and then allow the handles to open FULLY.
3. Insert the contact into the slot in the contact locator/support, making sure that the shoulder of the contact butts against the locator/support. Push the contact straight into the slot until the contact bottoms.

NOTE *The contact inspection hole should be positioned as shown in Figure 3.*

4. Slowly squeeze tool handles until contact is held firmly in place. Do NOT deform the insulation barrel or wire barrel of the contact.

5. Insert wire into wire barrel of contact until wire bottoms.

NOTE *Stripped portion of wire should be visible through inspection hole.*

6. While holding wire in place, continue to close tool handles until ratchet releases. Allow handles to open FULLY and remove crimped contact.

7. Check to make certain that that contact is properly crimped—wire strands must be visible through the inspection hole of the contact.

NOTE

For detailed inspection requirements, refer to Application Specification 114-10026.

4. MAINTENANCE AND INSPECTION

AMP recommends that a maintenance and inspection program be performed periodically to ensure dependable and uniform terminations. Frequency of inspection depends on:

1. The care, amount of use, and handling of the hand tool.
2. The presence of abnormal amounts of dust and dirt.
3. The degree of operator skill.
4. Your own established standards.

The hand tool is inspected before being shipped; however, AMP recommends that the tool be inspected immediately upon its arrival at your facility to ensure that the tool has not been damaged during shipment. Due to the precision design, it is important that no parts of these tools be interchanged except those replacement parts listed in Figure 5.

4.1. Daily Maintenance

1. Remove dust, moisture, and other contaminants with a clean brush, or a soft, lint-free cloth. Do NOT use objects that could damage the tool.
2. Make certain that the retaining pins are in place and that they are secured with retaining rings.

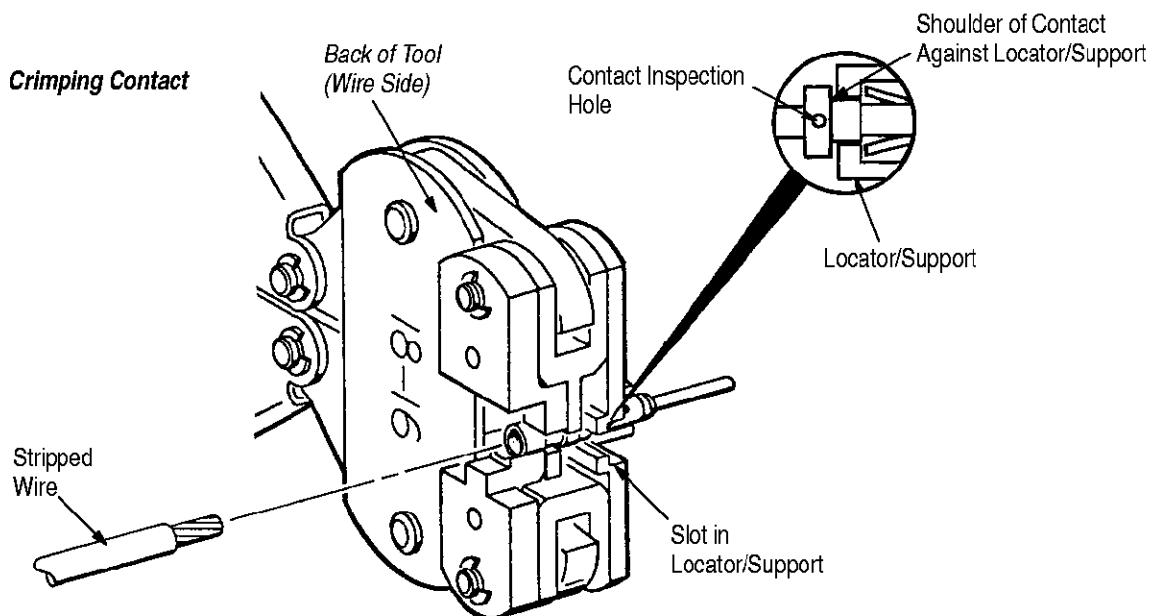

Figure 3

3. All pins, pivot points, and bearing surfaces should be protected with a thin coat of any good SAE 20 motor oil. Do not oil excessively.

4. When the tool is not in use, keep handles closed to prevent objects from becoming lodged in the crimping dies. Store the tool in a clean, dry area.

4.2. Lubrication

Lubricate all pins, pivot points, and bearing surfaces with SAE 20 motor oil as follows:

- Tools used in daily production—lubricate daily
- Tools used daily (occasional)—lubricate weekly
- Tools used weekly—lubricate monthly

Wipe excess oil from tool, particularly from crimping area. Oil transferred from the crimping area onto certain terminations may affect the electrical characteristics of an application.

4.3. Periodic Inspection

1. Hand tool should be immersed (handles partially closed) in a reliable commercial degreasing compound to remove accumulated dirt, grease, and foreign matter.
2. Close tool handles until ratchet releases and then allow them to open freely. If they do not open quickly and fully, the spring is defective and must be replaced. See Section 5, REPLACEMENT AND REPAIR.
3. Inspect head assembly for worn, cracked, or broken dies. If damage is evident, refer to Section 5, REPLACEMENT AND REPAIR, for information on obtaining further evaluation and repair.

4.4. Crimping Chamber Inspection

This inspection requires the use of a plug gage conforming to the dimensions shown in Figure 4. AMP does not manufacture or market these gages. To gage die closure, refer to Figure 4 and proceed as follows:

1. Remove traces of oil or dirt from the crimping chamber and plug gage.
2. Close the tool handles until it is evident that the dies have bottomed; then hold in this position. Do NOT force the dies beyond initial contact.
3. Align the GO element of the plug gage with the wire barrel crimping chamber. Push element straight into the chamber without using force. The GO element must pass completely through the chamber.
4. Check the wire barrel crimping chamber with the NO-GO element in the same manner as in Step 3. The NO-GO element may start entry, but must not pass completely through the crimping chamber.

Suggested Plug Gage Design

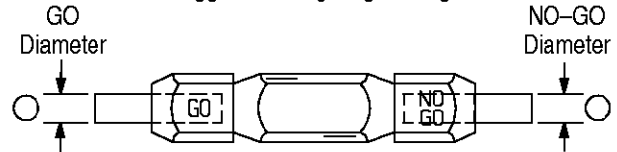

Die Closure Configuration 

GAGE ELEMENT DIAMETER	
GO	NO-GO
1.45 [.057]	1.61 [.063]

Inspection of Crimping Chamber

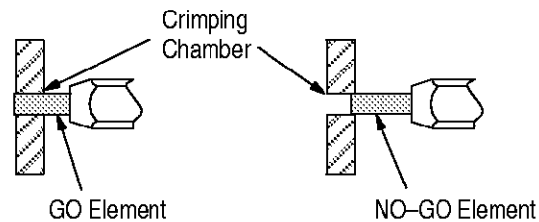

GO element must pass completely through the crimping chamber.

NO-GO element may enter partially, but must not pass completely through the crimping chamber.

Figure 4

If the crimping chamber conforms to the gage inspection, the tool may be considered dimensionally correct and should be lubricated with a THIN coat of any good SAE 20 motor oil. If the crimping chamber does NOT conform to the gage inspection, the tool must be returned to AMP for further evaluation and repair.

For additional information regarding the use of a plug gage, refer to 408-7424.

4.5. CERTI-CRIMP Ratchet Inspection

The CERTI-CRIMP ratchet on the hand tool should be checked to ensure that the ratchet does not release prematurely, allowing the crimping dies to open before they have fully bottomed. Obtain a 0.025 [.001] shim that is suitable for checking the clearance between the bottoming surfaces of the crimping dies. Proceed as follows:

1. Select the *maximum* size wire and corresponding contact for the tool.
2. Position the contact and wire between the crimping jaws, as described in Section 3, CRIMPING PROCEDURE.

3. Hold the contact (with wire) in place and squeeze the handles until the ratchet releases. Hold the handles in this position, maintaining just enough tension to keep the dies closed.

4. Check the clearance between the bottoming surfaces of the crimping dies. If the clearance is 0.025 [.001] or less, the ratchet is satisfactory. If clearance exceeds 0.025 [.001], the ratchet is out of adjustment and must be repaired. See Section 5, REPLACEMENT AND REPAIR.

5. REPLACEMENT AND REPAIR

Replacement parts are listed in Figure 5. Parts other than those listed should be replaced by AMP to ensure quality and reliability of the tool. Order replacement parts through your AMP representative, or call 1-800-526-5142, or send a facsimile of your purchase order to 717-986-7605, or write to:

CUSTOMER SERVICE (38-35)
AMP INCORPORATED
PO BOX 3608
HARRISBURG PA 17105-3608

For customer repair service, please contact an AMP representative at 1-800-526-5136.

6. REVISION SUMMARY

Revisions to this instruction sheet per EC 0990-0739-99 include:

- Updated document to corporate requirements
- Changed title of document
- Added NOTE to Section 3, Step 7
- Replaced customer repair address with phone number

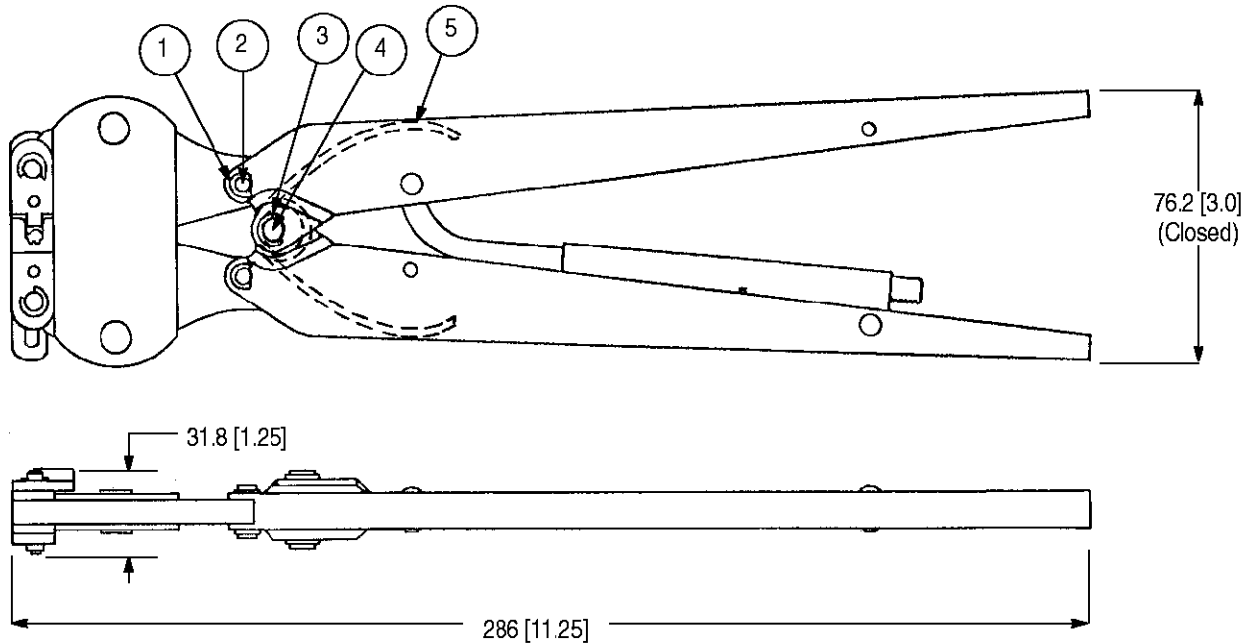

Weight: 539 g [1 lb, 3 oz] (Approx)

REPLACEMENT PARTS			
ITEM	PART NUMBER	DESCRIPTION	QTY PER TOOL
1	21045-3	RING, Retaining	1
2	8-59558-2	PIN, Retaining	1
3	21045-6	RING, Retaining	1
4	2-23620-9	PIN, Retaining	1
5	39364	SPRING	1

Figure 5